

**Board 8**  
West Deals  
None Vul

485 donnes d'interventions

♠ K J 9		♠ A Q 8 7 2
♥ 6		♥ Q 9
♦ Q 10 8 6 4 3		♦ J 2
♣ K 4 2		♣ A 10 7 3
♠ 5 4 3	<div style="display: inline-block; background-color: #008000; color: white; padding: 5px; border: 1px solid black;">           N W     E S         </div>	♠ 10 6
♥ A J 10 8 4		♥ K 7 5 3 2
♦ 7 5		♦ A K 9
♣ J 9 5		♣ Q 8 6

EW 2♠; EW 2♥; N 3♦; NS 1N; S 2♦; EW 2♣; Par +100:  
EW 3♥×-1; EW 3♠×-1

West	North	East	South
<i>connaii</i>	<i>miamiwiz</i>	<i>wstf</i>	<i>jec</i>
Pass	Pass	1 ♠	Pass
2 ♠	3 ♦	Pass	Pass
3 ♠	Pass	Pass	Pass

3 ♠ by East

<i>Trick</i>	<i>Lead</i>	<i>2nd</i>	<i>3rd</i>	<i>4th</i>
1. S	<u>♦ A</u>	5	6	2
2. S	<u>♥ 2</u>	10	6	<u>Q</u>
3. E	<u>♠ A</u>	6	3	9
4. E	<u>♠ 7</u>	10	4	<u>J</u>
5. N	<u>♣ 2</u>	7	<u>Q</u>	5
6. S	<u>♦ K</u>	7	8	J
7. S	<u>♣ 8</u>	9	K	<u>A</u>

Down 1 — NS +50

**Board 9**  
 North Deals  
 E-W Vul

♠ K J 9 3 2 ♥ 10 ♦ A Q 10 7 3 ♣ 9 7		♠ Q 5 4 ♥ 9 6 5 4 2 ♦ 8 4 ♣ A 10 4	♠ A 10 ♥ Q J 8 3 ♦ 6 ♣ K Q J 6 3 2
		♠ 8 7 6 ♥ A K 7 ♦ K J 9 5 2 ♣ 8 5	

EW 4N; EW 4♠; EW 4♣; EW 2♥; EW 3♦; Par -630

West	North	East	South
<i>connaii</i>	<i>miamiwiz</i>	<i>wstf</i>	<i>jec</i>
	Pass	1 ♣	1 ♦
1 ♠	Pass	2 ♣	Pass
2 NT	Pass	3 NT	Pass
Pass	Pass		

3 NT by West

Trick	Lead	2nd	3rd	4th
1. N	♦ 8	6	2	<u>10</u>
2. W	♣ 9	4	<u>K</u>	8
3. E	♣ Q	5	7	<u>A</u>
4. N	♠ 4	<u>A</u>	6	2
5. E	♣ J	♦ 5	♦ 3	10
6. E	♣ 6	♥ 7	♦ 7	♥ 2
7. E	♣ 3	♦ 9	♥ 10	♦ 4
8. E	♣ 2	♠ 8	♠ 3	♥ 4
9. E	♠ 10	7	<u>K</u>	5
10. W	♦ A	♥ 5	♥ 3	J

Made 3 — NS -600

**Board 16**  
West Deals  
E-W Vul

<p>♠ 8 6 4 ♥ 6 5 ♦ 9 7 3 ♣ Q 9 8 6 2</p>		<p>♠ J 10 3 ♥ K 3 ♦ 10 6 5 4 2 ♣ K 10 5</p>	<p>♠ A K Q 9 7 ♥ 9 8 4 ♦ K Q ♣ J 7 3</p>
<p>♠ 5 2 ♥ A Q J 10 7 2 ♦ A J 8 ♣ A 4</p>			

NS 4♥; NS 4♦; NS 2N; EW 1♣; Par +420

West	North	East	South
<i>connaii</i>	<i>miamiwiz</i>	<i>wstf</i>	<i>jec</i>
Pass	Pass	1 ♠	Dbl
Pass	2 ♦	Pass	3 ♥
Pass	3 ♠	Dbl	Pass
Pass	4 ♥	Pass	Pass

4 ♥ by South

Trick	Lead	2nd	3rd	4th
1. W	♠ 6	3	<u>K</u>	2
2. E	♠ A	5	8	10
3. E	♣ 3	<u>A</u>	2	5
4. S	♥ 2	5	<u>K</u>	4
5. N	♥ 3	8	<u>A</u>	6
6. S	♥ Q	♣ 6	♦ 2	9
7. S	♥ J	♠ 4	♦ 4	♠ 7
8. S	♥ 10	♣ 8	♠ J	♠ 9
9. S	♣ 4	9	<u>K</u>	7
10. N	♦ 5	Q	<u>A</u>	3
11. S	♦ J	7	6	<u>K</u>
12. E	♠ Q	-	-	-

Made 4 — NS +420

**Board 19**  
 South Deals  
 E-W Vul

♠ 5	♠ J 8 6 2	♠ A K 10 7 4 3
♥ A 8 7 5	♥ 9 6 3	♥ K 10 4
♦ K 10 8 7 6 4	♦ A 9 5	♦ J 2
♣ K 8	♣ A 7 4	♣ 9 2

W	N	E
	S	

♠ Q 9
♥ Q J 2
♦ Q 3
♣ Q J 10 6 5 3

W 2♠; EW 2♥; W 3♦; NS 1N; E 2♦; E 1♠; NS 1♣; Par -110

West	North	East	South
<i>connaii</i>	<i>miamiwiz</i>	<i>wstf</i>	<i>jec</i>
Pass	Pass	2 ♠	3 ♣
Pass	Pass	Pass	Pass

3 ♣ by South

Trick	Lead	2nd	3rd	4th
1. W	♠ 5	2	<u>K</u>	9
2. E	♠ 7	Q	<u>♣ 8</u>	6
3. W	<u>♥ A</u>	3	10	2
4. W	♥ 8	6	<u>K</u>	J
5. E	♠ 4	♦ 3	<u>♣ K</u>	8
6. W	♥ 5	9	4	<u>Q</u>

Down 1 — NS -50

**Board 22**  
 East Deals  
 E-W Vul

	♠ K Q 6 2											
	♥ J 10 6 5											
	♦ Q J											
	♣ Q 7 3											
♠ J 4	<table style="border: 1px solid green; width: 40px; height: 40px; margin: auto;"> <tr><td></td><td style="text-align: center;">N</td><td></td></tr> <tr><td style="text-align: center;">W</td><td style="background-color: green;"></td><td style="text-align: center;">E</td></tr> <tr><td></td><td style="text-align: center;">S</td><td></td></tr> </table>		N		W		E		S		♠ 9 8	
	N											
W		E										
	S											
♥ A Q 8 3 2		♥ 9 7 4										
♦ —		♦ A K 10 8 7 6										
♣ A K J 9 4 2		♣ 8 5										
	♠ A 10 7 5 3											
	♥ K											
	♦ 9 5 4 3 2											
	♣ 10 6											

EW 3♥; NS 2♠; EW 1N; EW 2♦; EW 2♣; Par -100; NS 3♠×-1

West	North	East	South
<i>connaii</i>	<i>miamiwiz</i>	<i>wstf</i>	<i>jec</i>
		Pass	Pass
1 ♣	Pass	1 ♦	1 ♠
2 ♥	2 ♠	3 ♦	Pass
3 ♥	3 ♠	4 ♥	Pass
Pass	Pass		

4 ♥ by West

Trick	Lead	2nd	3rd	4th
1. N	♠ K	8	7	4
2. N	♠ 2	9	<u>A</u>	J
3. S	♣ 6	<u>A</u>	3	5
4. W	♥ A	5	4	K
5. W	♣ K	7	8	10
6. W	♣ 2	Q	♥ 7	♠ 3
7. E	♥ 9	♠ 5	-	-

Down 1 — NS +100

**Board 24**  
 West Deals  
 None Vul

♠ 9 8 ♥ A Q 9 7 6 ♦ Q 10 6 ♣ Q 3 2		♠ Q J 7 5 4 ♥ J 10 8 ♦ 9 7 ♣ J 6 5	♠ 3 ♥ 4 2 ♦ K J 8 5 4 3 ♣ A K 10 4
♠ A K 10 6 2 ♥ K 5 3 ♦ A 2 ♣ 9 8 7			

EW 5♦; EW 5♣; EW 3♥; EW 1N; Par -400

West	North	East	South
<i>connaii</i>	<i>miamiwiz</i>	<i>wstf</i>	<i>jec</i>
Pass	Pass	1♦	1♠
2♥	3♠	Pass	Pass
Pass			

3♠ by South

<i>Trick</i>	<i>Lead</i>	<i>2nd</i>	<i>3rd</i>	<i>4th</i>
1. W	♠ 9	<u>Q</u>	3	2
2. N	♠ 4	♦ 4	<u>A</u>	8
3. S	♣ 7	2	J	<u>K</u>
4. E	♦ 3	<u>A</u>	10	7
5. S	♣ 9	<u>Q</u>	5	4
6. W	♦ Q	9	<u>K</u>	2
7. E	♥ 4	3	<u>Q</u>	8
8. W	<u>♥ A</u>	10	2	5
9. W	♣ 3	6	<u>A</u>	8
10. E	♦ 5	-	-	-

Down 2 — NS -100

**Board 26**  
 East Deals  
 Both Vul

♠ 8	♠ K Q 10 3 2	♠ A 6
♥ 6 3 2	♥ A K 10 7	♥ J 9 4
♦ 7 5 4 2	♦ J	♦ K Q 10 3
♣ 10 6 5 4 3	♣ A Q 9	♣ K J 8 7

♠ J 9 7 5 4
♥ Q 8 5
♦ A 9 8 6
♣ 2

NS 6♠; NS 4N; NS 4♥; N 2♦; S 1♦; NS 1♣; Par +1430

West	North	East	South
<i>connaii</i>	<i>miamiwiz</i>	<i>wstf</i>	<i>jec</i>
Pass	Dbl	1♦	Pass
Pass	4♦	Pass	1♠
Pass	5♥	Pass	5♦
Pass	Pass	Pass	6♠

6♠ by South

<i>Trick</i>	<i>Lead</i>	<i>2nd</i>	<i>3rd</i>	<i>4th</i>
1. W	♣ 6	<u>A</u>	8	2
2. N	♠ K	<u>A</u>	4	8
3. E	♣ K	-	-	-

Made 6 — NS +1430

**Board 30**  
 East Deals  
 N-S Vul

♠ 5 3 2 ♥ K 8 7 ♦ 8 6 2 ♣ J 9 5 4		♠ A 6 4 ♥ A J 10 5 4 2 ♦ K Q 4 ♣ K	♠ K Q J ♥ 9 6 3 ♦ A J 5 ♣ A Q 6 2
♠ 10 9 8 7 ♥ Q ♦ 10 9 7 3 ♣ 10 8 7 3			

EW 1N; EW 2♣; NS 1♥; N 1♦; Par -90

West	North	East	South
<i>mpasternak</i>	<i>smispi</i>	<i>thejuwel</i>	<i>jec</i>
Pass	Dbl	1 NT	Pass
Pass	Pass	Pass	2 ♠

2 ♠ by South

<i>Trick</i>	<i>Lead</i>	<i>2nd</i>	<i>3rd</i>	<i>4th</i>
1. W	♥ 7	<u>A</u>	6	Q
2. N	♦ <u>K</u>	5	3	2
3. N	♦ 4	<u>J</u>	7	6
4. E	♥ 3	♣ 3	<u>K</u>	2
5. W	♣ 4	K	<u>A</u>	8
6. E	♦ <u>A</u>	10	8	Q
7. E	♣ 2	7	9	<u>♠ 4</u>
8. N	♥ <u>J</u>	9	♣ 10	8
9. N	<u>♠ A</u>	Q	7	2
10. N	♠ 6	<u>J</u>	8	3
11. E	♣ Q	<u>♠ 9</u>	5	♥ 4
12. S	♦ 9	♠ 5	♥ 5	<u>♠ K</u>
13. E	♣ 6	<u>♠ 10</u>	J	♥ 10

Down 1 — NS -100



**Board 34**  
 East Deals  
 E-W Vul

♠ 2	♠ A K 4 3	♠ 9 6 5
♥ A 9 6 5	♥ K J 4	♥ Q 8 3 2
♦ A K Q 9	♦ 10 6 5	♦ J 8 7 3
♣ Q J 5 3	♣ A 9 6	♣ 8 7

♠ Q J 10 8 7
♥ 10 7
♦ 4 2
♣ K 10 4 2

NS 3♠; EW 3♥; NS 2N; EW 2♦; NS 2♣; Par +140

West	North	East	South
<i>mpasternak</i>	<i>smispi</i>	<i>thejuwel</i>	<i>jec</i>
		Pass	Pass
1 ♣	1 NT	Pass	2 ♥
Dbl	2 ♠	Pass	Pass

Pass

2 ♠ by North

<i>Trick</i>	<i>Lead</i>	<i>2nd</i>	<i>3rd</i>	<i>4th</i>
1. E	♣ 8	2	J	<u>A</u>
2. N	<u>♠ A</u>	6	7	2
3. N	♠ 3	5	<u>J</u>	♥ 5
4. S	♥ 7	6	<u>K</u>	2
5. N	<u>♠ K</u>	9	8	♦ 9
6. N	♣ 6	7	<u>K</u>	3
7. S	♣ 4	5	<u>9</u>	♥ 3

Made 4 — NS +170

**Board 35**  
 South Deals  
 Both Vul

	♠ Q J 9 8 3		
	♥ A		
	♦ K 10		
	♣ A K 8 7 5		
♠ 6 4 ♥ K Q J 9 4 3 ♦ 6 4 ♣ 4 3 2	<div style="display: inline-block; background-color: green; color: white; padding: 5px; border: 1px solid black;">       N W     E S     </div>	♠ A 5 ♥ 10 7 6 5 2 ♦ Q 9 7 3 ♣ 10 6	
	♠ K 10 7 2		
	♥ 8		
	♦ A J 8 5 2		
	♣ Q J 9		

NS 6♠; NS 6♣; NS 3N; NS 5♦; EW 1♥; Par +1430

West	North	East	South
<i>mpasternak</i>	<i>smispi</i>	<i>thejuwel</i>	<i>jec</i>
			Pass
2♥	2♠	4♥	4♠
Pass	Pass	Pass	

4♠ by North

<i>Trick</i>	<i>Lead</i>	<i>2nd</i>	<i>3rd</i>	<i>4th</i>
1. E	♥ 7	8	J	<u>A</u>
2. N	♠ 8	5	2	4
3. N	♠ 3	<u>A</u>	7	6

Made 6 — NS +680

**Board 40**  
West Deals  
N-S Vul

♠ A Q 8 6 5 4 3	<div style="display: inline-block; background-color: green; color: white; padding: 5px; border: 1px solid black;">             N W     E S           </div>	♠ —
♥ K Q 7 2		♥ J 4
♦ 2		♦ 8 7 6 5
♣ J		♣ A K 10 9 8 7 4

♠ J 9
♥ A 10 9 8 6 3
♦ Q 9 3
♣ 5 2

NS 2N; EW 2♠; NS 2♦; EW 1♣; Par +100; EW 3♠×-1

West	North	East	South
<i>mpasternak</i>	<i>smispi</i>	<i>thejuwel</i>	<i>jec</i>
1 ♠	2 ♦	Pass	2 ♥
2 ♠	Pass	3 ♣	3 ♦
4 ♠	Dbl	Pass	Pass

Pass

4 ♠× by West

<i>Trick</i>	<i>Lead</i>	<i>2nd</i>	<i>3rd</i>	<i>4th</i>
1. N	♦ <u>K</u>	5	3	2
2. N	♦ 10	6	Q	♠ <u>3</u>
3. W	♠ <u>A</u>	2	♣ 4	9
4. W	♠ 4	7	♦ 7	♠ <u>J</u>
5. S	♦ 9	♠ <u>5</u>	4	8
6. W	♠ 6	<u>10</u>	♣ 7	♥ 8
7. N	♠ <u>K</u>	♣ 8	♥ 3	8
8. N	♥ 5	4	<u>A</u>	2
9. S	♥ 6	-	-	-

Down 2 — NS +300

**Board 43**  
 South Deals  
 N-S Vul

♠ A K 9 6 4 ♥ A J ♦ K 4 ♣ 10 8 6 5		♠ 10 3 2 ♥ K Q 9 2 ♦ 10 9 7 ♣ A 3 2	♠ 8 7 ♥ 8 6 5 ♦ 6 5 2 ♣ K Q J 9 4
		♠ Q J 5 ♥ 10 7 4 3 ♦ A Q J 8 3 ♣ 7	

EW 4♣; EW 2N; EW 2♠; NS 2♥; NS 2♦; Par -130

West	North	East	South
<i>mpasternak</i>	<i>smispi</i>	<i>thejuwel</i>	<i>jec</i>
			Pass
1 ♠	Pass	1 NT	Pass
2 ♣	Pass	Pass	Dbl
Rdbl	2 ♥	3 ♣	Pass
Pass	Pass		

3 ♣ by West

<i>Trick</i>	<i>Lead</i>	<i>2nd</i>	<i>3rd</i>	<i>4th</i>
1. N	♥ K	5	7	<u>A</u>
2. W	♣ 5	2	<u>K</u>	7
3. E	♣ Q	♦ 8	6	<u>A</u>
4. N	♥ <u>Q</u>	6	3	J
5. N	♦ 7	2	<u>A</u>	4
6. S	♦ Q	<u>K</u>	9	5
7. W	♠ <u>A</u>	2	7	5
8. W	♠ <u>K</u>	3	8	Q
9. W	♠ 4	10	<u>♣ 4</u>	J
10. E	♦ 6	J	<u>♣ 8</u>	10
11. W	♠ 6	♣ 3	<u>♣ 9</u>	♦ 3

Made 4 — NS -130

**Board 46**  
 East Deals  
 N-S Vul

♠ A Q 10 6 ♥ Q 9 5 ♦ 7 4 ♣ K Q 7 4		♠ K 2 ♥ A K 6 2 ♦ K 9 ♣ A 9 5 3 2	♠ J 7 3 ♥ 10 8 4 3 ♦ Q 10 3 2 ♣ J 10
		♠ 9 8 5 4 ♥ J 7 ♦ A J 8 6 5 ♣ 8 6	

S 2♥; NS 3♦; NS 3♣; NS 1N; NS 1♠; N 1♥; Par +110

West	North	East	South
<i>mpasternak</i>	<i>smispi</i>	<i>thejuwel</i>	<i>jec</i>
		Pass	Pass
1 ♣	1 NT	Pass	Pass

Pass

1 NT by North

<i>Trick</i>	<i>Lead</i>	<i>2nd</i>	<i>3rd</i>	<i>4th</i>
1. E	♥ 3	J	Q	<u>K</u>
2. N	♣ 2	<u>10</u>	6	4
3. E	♥ 4	7	<u>9</u>	2
4. W	♥ 5	<u>A</u>	8	♦ 5
5. N	♥ 6	<u>10</u>	♠ 4	♦ 4
6. E	♦ 2	8	7	<u>K</u>
7. N	♦ 9	3	<u>J</u>	♠ 6
8. S	<u>♦ A</u>	♣ 7	♣ 3	10
9. S	♠ 5	<u>A</u>	2	7
10. W	♣ K	<u>A</u>	J	8
11. N	♣ 5	♦ Q	♠ 8	<u>Q</u>
12. W	♠ 10	-	-	-

Made 2 — NS +120

**Board 48**  
West Deals  
Both Vul

♠ A 9 5 4 3 2		♠ K Q 10 8 7
♥ J 8 7		♥ 5 4 2
♦ K 5		♦ J 9
♣ 8 5		♣ 10 6 4
♠ J 6	<div style="display: inline-block; background-color: green; color: white; padding: 5px; border: 1px solid black;">             N W     E S           </div>	
♥ K 10 3		
♦ A Q 4		
♣ K Q 7 3 2		
♠ —		
♥ A Q 9 6		
♦ 10 8 7 6 3 2		
♣ A J 9		

S 3♥; N 2♥; NS 3♦; W 1N; EW 1♠; EW 1♣; Par +140

West	North	East	South
<i>mpasternak</i>	<i>smispi</i>	<i>thejuwel</i>	<i>jec</i>
1 NT	Pass	2♥	Dbl
2♠	Pass	Pass	3♦
Pass	3♥	3♠	Pass
Pass	Pass		

3♠ by West

Trick	Lead	2nd	3rd	4th
1. N	♥ 7	2	<u>A</u>	3
2. S	♥ 6	<u>K</u>	8	4
3. W	♠ J	<u>A</u>	7	♦ 3
4. N	♠ 5	<u>8</u>	♦ 6	6
5. E	♣ 4	9	<u>K</u>	5
6. W	♥ 10	J	5	<u>Q</u>
7. S	♦ 7	4	<u>K</u>	9
8. N	♠ 4	<u>10</u>	♦ 2	♣ 2
9. E	♦ J	8	<u>A</u>	5
10. W	♦ Q	♠ 2	<u>♠ Q</u>	10
11. E	♣ 6	<u>A</u>	3	8
12. S	♥ 9	♣ 7	♠ 3	<u>♠ K</u>
13. E	♣ 10	J	Q	<u>♠ 9</u>

Down 2 — NS +200

**Board 49**  
 North Deals  
 None Vul

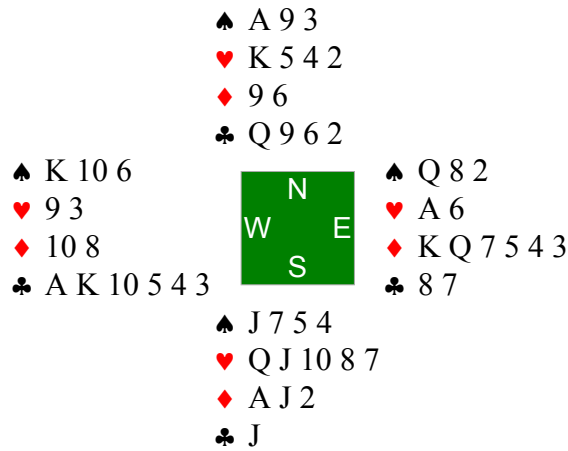

NS 2♥; EW 3♦; NS 1N; EW 2♣; NS 1♠; Par -100: NS 3♥×-1

West	North	East	South
<i>gateway</i>	<i>smispi</i>	<i>hewex</i>	<i>jec</i>
	Pass	1♦	1♥
2♣	2♦	3♦	Pass
Pass	3♥	Pass	Pass

Pass

3♥ by South

Trick	Lead	2nd	3rd	4th
1. W	<u>♣K</u>	2	8	J
2. W	♣5	<u>Q</u>	7	♠4
3. N	♥2	6	<u>Q</u>	3
4. S	♥10	9	4	<u>A</u>
5. E	<u>♦K</u>	2	8	6
6. E	♦4	<u>J</u>	10	9
7. S	<u>♦A</u>	♣3	♠3	3
8. S	♠5	6	<u>A</u>	8
9. N	♠9	2	7	<u>10</u>
10. W	♣A	-	-	-

Made 3 — NS +140

**Board 58**  
 East Deals  
 Both Vul

♠ K 10 9 4 3	♠ —	♠ A Q J 7 2
♥ K Q J 7 3	♥ 10 8 4 2	♥ A 9 5
♦ 3	♦ A K 8 6	♦ 10 5
♣ J 6	♣ K Q 9 7 5	♣ 4 3 2

♠ 8 6 5
♥ 6
♦ Q J 9 7 4 2
♣ A 10 8

NS 6♦; EW 4♠; NS 5♣; W 2♥; E 1♥; Par +500: EW 6♠×-2

West	North	East	South
<i>gateway</i>	<i>smispi</i>	<i>hewex</i>	<i>jec</i>
		1 ♠	Pass
4 ♦	Dbl	Pass	5 ♦
5 ♠	Pass	Pass	Pass

5 ♠ by East

<i>Trick</i>	<i>Lead</i>	<i>2nd</i>	<i>3rd</i>	<i>4th</i>
1. S	♥ 6	3	2	<u>9</u>
2. E	♠ A	5	3	♣ 7
3. E	♠ Q	6	4	♦ 8
4. E	♠ 2	8	<u>9</u>	♣ 5
5. W	♥ 7	4	<u>A</u>	♦ Q
6. E	♥ 5	♦ 2	-	-

Made 5 — NS -650



**Board 60**  
West Deals  
N-S Vul

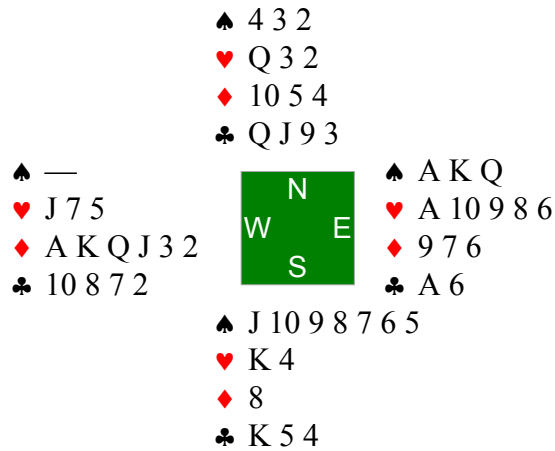

EW 6♥; EW 6♦; EW 5N; EW 3♣; NS 1♠; Par -980

West	North	East	South
<i>gateway</i>	<i>smispi</i>	<i>hewex</i>	<i>jec</i>
1 ♦	Pass	1 ♥	2 ♠
Dbl	Pass	3 ♠	Pass
4 ♦	Pass	5 ♥	Pass
Pass	Pass		

5 ♥ by East

<i>Trick</i>	<i>Lead</i>	<i>2nd</i>	<i>3rd</i>	<i>4th</i>
1. S	♠ J	♣ 2	2	<u>K</u>
2. E	♥ 6	4	5	<u>Q</u>
3. N	♣ Q	<u>A</u>	4	7
4. E	♥ <u>A</u>	K	7	3
5. E	♠ <u>A</u>	5	♣ 8	4
6. E	♠ <u>Q</u>	6	♣ 10	3
7. E	♥ 8	♠ 7	<u>J</u>	2

Made 6 — NS -480

**Board 64**  
 West Deals  
 Both Vul

	♠ Q J 3 2		
	♥ 2		
	♦ A K J 7 2		
	♣ 8 7 6		
♠ 10 8 ♥ K Q 7 6 4 ♦ 9 3 ♣ A Q 9 3	<div style="background-color: #006400; color: white; padding: 10px; display: inline-block; text-align: center;">       N W     E S     </div>	♠ K 9 7 ♥ J 3 ♦ 8 6 5 4 ♣ K J 4 2	
	♠ A 6 5 4		
	♥ A 10 9 8 5		
	♦ Q 10		
	♣ 10 5		

NS 4♠; NS 2N; NS 3♦; NS 1♥; EW 1♣; Par +620

West	North	East	South
<i>faramarz</i>	<i>ronpa</i>	<i>esw</i>	<i>jec</i>
1 ♥	Dbl	Pass	2 ♠
Pass	Pass	Pass	

2 ♠ by South

<i>Trick</i>	<i>Lead</i>	<i>2nd</i>	<i>3rd</i>	<i>4th</i>
1. W	♦ 3	2	4	<u>Q</u>
2. S	♠ A	8	2	7
3. S	♠ 4	10	J	<u>K</u>
4. E	♣ 2	10	<u>Q</u>	6
5. W	♣ A	7	4	5
6. W	♣ 9	8	J	<u>♠ 5</u>
7. S	♠ 6	♥ 4	<u>Q</u>	9

Made 4 — NS +170

**Board 68**  
 West Deals  
 None Vul

♠ Q 7 5 4 ♥ — ♦ K 10 7 6 4 ♣ 7 6 4 3		♠ A J 6 ♥ K 9 8 2 ♦ J 5 ♣ J 10 5 2	♠ 10 8 2 ♥ A Q J 6 5 4 ♦ A 9 8 ♣ Q
		♠ K 9 3 ♥ 10 7 3 ♦ Q 3 2 ♣ A K 9 8	

NS 2N; EW 2♦; NS 2♣; NS 1♠; EW 1♥; Par +100; EW 3♦×-1

West	North	East	South
<i>faramarz</i>	<i>ronpa</i>	<i>esw</i>	<i>jec</i>
Pass	Pass	1 ♥	Dbl
1 ♠	1 NT	2 ♥	Pass
Pass	2 NT	Pass	Pass
Pass			

2 NT by North

<i>Trick</i>	<i>Lead</i>	<i>2nd</i>	<i>3rd</i>	<i>4th</i>
1. E	♥ Q	3	♣ 3	<u>K</u>
2. N	♣ 2	Q	<u>K</u>	6
3. S	♣ 8	4	5	♥ 5
4. S	♣ A	7	10	♥ 6
5. S	♣ 9	♦ 4	<u>J</u>	♥ 4
6. N	♥ 2	<u>J</u>	7	♠ 4
7. E	♦ 9	2	6	<u>J</u>
8. N	♥ 8	<u>A</u>	10	♠ 5
9. E	♦ A	3	7	5
10. E	♦ 8	Q	<u>K</u>	♠ 6
11. W	♦ 10	♠ J	♠ 2	♠ 3
12. W	♠ 7	<u>A</u>	8	9
13. N	♥ 9	♠ 10	♠ K	♠ Q

Made 2 — NS +120

**Board 76**  
 West Deals  
 E-W Vul

♠ A 7 6 ♥ A K 10 8 5 ♦ K Q 9 5 ♣ K		♠ Q 10 9 4 3 ♥ 6 ♦ A 2 ♣ A Q 7 6 2	♠ 2 ♥ 7 4 3 2 ♦ J 6 4 3 ♣ J 10 8 5
		♠ K J 8 5 ♥ Q J 9 ♦ 10 8 7 ♣ 9 4 3	

EW 5♥; EW 5♦; NS 3♠; NS 2♣; Par -300: NS 5♠×-2

West	North	East	South
<i>faramarz</i>	<i>ronpa</i>	<i>esw</i>	<i>jec</i>
1 ♥	3 ♣ <sup>1</sup>	Pass	Pass
Dbl	Pass	3 ♥	Pass
4 ♥	Pass	Pass	Pass

1. ♣ and ♠

4 ♥ by West

<i>Trick</i>	<i>Lead</i>	<i>2nd</i>	<i>3rd</i>	<i>4th</i>
1. N	♠ 3	2	K	<u>A</u>
2. W	♠ 6	4	<u>♥ 2</u>	5
3. E	♥ 3	9	<u>A</u>	6
4. W	<u>♥ K</u>	♣ 7	4	J
5. W	♠ 7	9	<u>♥ 7</u>	8
6. E	♦ 3	7	Q	<u>A</u>
7. N	♠ Q	♣ 5	J	<u>♥ 5</u>
8. W	♦ 5	2	J	8

Made 4 — NS -620

**Board 78**  
 East Deals  
 N-S Vul

♠ A 10 9 7 ♥ 7 6 ♦ K 10 9 2 ♣ A 6 5		♠ K ♥ A Q J 10 3 2 ♦ Q J 7 4 3 ♣ 4	♠ Q J 5 4 3 ♥ K 9 4 ♦ — ♣ K 10 9 3 2
♠ 8 6 2 ♥ 8 5 ♦ A 8 6 5 ♣ Q J 8 7			

EW 5♠; W 3N; EW 4♣; E 2N; NS 2♥; NS 1♦; Par -450

West	North	East	South
<i>faramarz</i>	<i>ronpa</i>	<i>esw</i>	<i>jec</i>
		Pass	Pass
1 ♦	1 ♥	1 ♠	Pass
2 ♠	3 ♥	4 ♠	Pass
Pass	Pass		

4 ♠ by East

<i>Trick</i>	<i>Lead</i>	<i>2nd</i>	<i>3rd</i>	<i>4th</i>
1. S	♥ 8	7	<u>A</u>	9
2. N	♦ 3	<u>♠ 3</u>	6	2
3. E	♠ Q	2	7	<u>K</u>
4. N	♥ Q	<u>K</u>	5	6
5. E	♠ 4	6	<u>10</u>	♥ 3
6. W	<u>♠ A</u>	♦ 7	5	8
7. W	<u>♣ A</u>	4	2	7
8. W	♣ 6	♥ 2	9	<u>J</u>
9. S	♦ 5	<u>K</u>	4	♥ 4
10. W	♣ 5	♥ 10	<u>K</u>	8
11. E	♣ 3	Q	<u>♠ 9</u>	♦ J

Made 4 — NS -420

**Board 79**  
 South Deals  
 E-W Vul

♠ K 8 2 ♥ Q 9 8 7 4 2 ♦ Q 8 7 ♣ 9		♠ A 9 6 3 ♥ 5 ♦ K J 10 9 2 ♣ 6 5 2	♠ Q 10 ♥ A 10 6 3 ♦ A 4 3 ♣ A J 8 4
♠ J 7 5 4 ♥ K J ♦ 6 5 ♣ K Q 10 7 3			

EW 4♥; EW 1N; NS 2♣; NS 1♠; W 1♦; Par -500: NS 4♠×-3;  
 NS 5♣×-3

West	North	East	South
<i>faramarz</i>	<i>ronpa</i>	<i>esw</i>	<i>jec</i>
			Pass
2♦ <sup>1</sup>	Pass	4♣ <sup>2</sup>	Dbl
4♦	Dbl	4♥	Pass
Pass	Pass		

1. multi weak M
2. transfer the suit

4♥ by East

<i>Trick</i>	<i>Lead</i>	<i>2nd</i>	<i>3rd</i>	<i>4th</i>
1. S	♦ 6	8	<u>10</u>	4
2. N	♣ 6	<u>A</u>	7	9
3. E	♥ <u>A</u>	J	2	5
4. E	♣ 4	3	♥ <u>4</u>	5
5. W	♠ 2	3	10	<u>J</u>
6. S	♦ 5	Q	K	<u>A</u>
7. E	♠ Q	4	8	<u>A</u>
8. N	♦ <u>9</u>	3	♠ 5	7
9. N	♣ 2	8	10	♥ <u>7</u>

Down 2 — NS +200

**Board 89**  
 North Deals  
 None Vul

♠ Q 10 9 4	♠ 8 5 3	♠ A K
♥ 6 4	♥ 10 8 3	♥ A Q 7
♦ A K Q 8	♦ J 6	♦ 10 9 7
♣ 8 7 2	♣ A K Q 10 5	♣ J 9 6 4 3

♠ J 7 6 2	<table border="1" style="background-color: #006400; color: white; width: 40px; height: 40px; margin: auto;"> <tr><td style="text-align: center;">N</td></tr> <tr><td style="text-align: center;">W E</td></tr> <tr><td style="text-align: center;">S</td></tr> </table>	N	W E	S	♠ A K
N					
W E					
S					
♥ K J 9 5 2		♥ A Q 7			
♦ 5 4 3 2		♦ 10 9 7			
♣ —		♣ J 9 6 4 3			

EW 3N; EW 3♠; E 2♥; EW 3♦; EW 2♣; Par -400

West	North	East	South
<i>carlosp</i>	<i>BridgeGoth</i>	<i>hectorc</i>	<i>jec</i>
	Pass	1 ♣	1 ♥
Dbl <sup>1</sup>	2 ♣	Pass	2 ♥
Dbl	Pass	2 NT	Pass
Pass	Pass		

1. 4 or more spades

2 NT by East

<i>Trick</i>	<i>Lead</i>	<i>2nd</i>	<i>3rd</i>	<i>4th</i>
1. S	♥ 5	4	10	<u>Q</u>
2. E	♠ A	2	4	3
3. E	♠ <u>K</u>	6	9	5
4. E	♦ 10	2	<u>A</u>	6
5. W	♦ <u>K</u>	J	7	3
6. W	♦ <u>Q</u>	♥ 3	9	4
7. W	♦ 8	♠ 8	♥ 7	5
8. W	♠ <u>Q</u>	♣ 5	♣ 3	7
9. W	♣ 2	<u>A</u>	4	♥ 2
10. N	♥ 8	<u>A</u>	9	6
11. E	♣ 6	-	-	-

Made 3 — NS -150

**Board 90**  
 East Deals  
 N-S Vul

♠ 8	♠ J 6	♠ K 5 4 3
♥ K 7 2	♥ 10 8 6 4	♥ A Q 5
♦ A 9 8 4	♦ J 7 6 3	♦ Q 10 2
♣ K Q 10 7 3	♣ J 8 2	♣ A 9 6

♠ A Q 10 9 7 2
♥ J 9 3
♦ K 5
♣ 5 4

E 5N; W 4N; EW 4♥; EW 5♦; EW 5♣; E 2♠; W 1♠; Par -460

West	North	East	South
<i>carlosp</i>	<i>BridgeGoth</i>	<i>hectorc</i>	<i>jec</i>
		1 NT	2 ♥ <sup>1</sup>
3 ♠ <sup>2</sup>	Pass	3 NT	Pass
Pass	Pass		

1. s

2. short ♠ GF

3 NT by East

<i>Trick</i>	<i>Lead</i>	<i>2nd</i>	<i>3rd</i>	<i>4th</i>
1. S	♠ Q	8	J	<u>K</u>
2. E	♣ 6	5	<u>K</u>	2
3. W	♣ 3	8	<u>A</u>	4
4. E	♣ 9	♠ 2	Q	J
5. W	<u>♣ 10</u>	♠ 6	♠ 3	♥ 3
6. W	<u>♣ 7</u>	♥ 4	♠ 4	♦ 5
7. W	♥ 2	6	<u>A</u>	9
8. E	♥ 5	J	<u>K</u>	8
9. W	♥ 7	10	Q	♠ 7
10. E	♠ 5	<u>A</u>	♦ 4	♦ 3
11. S	<u>♠ 10</u>	♦ 8	♦ 6	♦ 2
12. S	<u>♠ 9</u>	♦ 9	♦ 7	♦ 10
13. S	♦ K	<u>A</u>	J	Q

Made 4 — NS -430



**Board 92**  
 West Deals  
 Both Vul

♠ A 6	♠ Q 10 3	♠ 9 8 2
♥ 5 2	♥ J 10 9 7	♥ K Q 8 3
♦ A K 9 7 6	♦ J 8 3 2	♦ 10 5
♣ 9 8 7 3	♣ K 2	♣ A Q 10 4

♠ K J 7 5 4
♥ A 6 4
♦ Q 4
♣ J 6 5

EW 4♣; EW 1N; EW 2♦; EW 1♥; Par -130

West	North	East	South
<i>carlosp</i>	<i>BridgeGoth</i>	<i>hectorc</i>	<i>jec</i>
1 ♦	Pass	1 ♥	1 ♠
Pass	2 ♠	Dbl	Pass
3 ♣	Pass	Pass	Pass

3 ♣ by West

<i>Trick</i>	<i>Lead</i>	<i>2nd</i>	<i>3rd</i>	<i>4th</i>
1. N	♠ 3	2	<u>K</u>	6
2. S	♠ 5	<u>A</u>	10	8
3. W	♥ 5	7	K	<u>A</u>
4. S	♠ 4	<u>♣ 3</u>	Q	9
5. W	♥ 2	9	<u>Q</u>	6
6. E	♥ 3	4	<u>♣ 8</u>	10
7. W	<u>♦ A</u>	2	5	4
8. W	<u>♦ K</u>	3	10	Q
9. W	♦ 6	8	♣ 10	<u>♣ J</u>
10. S	♣ 5	9	K	<u>A</u>
11. E	♥ 8	♣ 6	<u>♣ 7</u>	J
12. W	♦ 7	J	<u>♣ 4</u>	♠ 7
13. E	<u>♣ Q</u>	♠ J	♦ 9	2

Made 4 — NS -130

**Board 94**  
 East Deals  
 E-W Vul

♠ Q 7 5 3 2 ♥ Q J 7 6 ♦ 5 3 ♣ 5 3		♠ K 10 9 4 ♥ K 8 4 2 ♦ K J 4 ♣ J 6	♠ A 8 ♥ A 10 9 5 ♦ 6 ♣ A K 10 9 4 2
		♠ J 6 ♥ 3 ♦ A Q 10 9 8 7 2 ♣ Q 8 7	

EW 4♥; N 2N; EW 2♠; NS 3♦; EW 3♣; Par -300; N 4N×-2;  
 NS 5♦×-2

West	North	East	South
<i>carlosp</i>	<i>BridgeGoth</i>	<i>hectorc</i>	<i>jec</i>
		1 ♣	4 ♦
Pass	5 ♦	Dbl	Pass
Pass	Pass		

5♦× by South

Trick	Lead	2nd	3rd	4th
1. W	♣ 5	6	<u>K</u>	8
2. E	<u>♣ A</u>	7	3	J
3. E	♣ 2	Q	♦ 5	<u>♦ J</u>
4. N	<u>♦ K</u>	6	2	3
5. N	♦ 4	♣ 4	<u>A</u>	♠ 7
6. S	♥ 3	<u>Q</u>	2	5
7. W	♥ J	K	A	<u>♦ 7</u>
8. S	<u>♦ 8</u>	♥ 6	♥ 4	♣ 9
9. S	♠ 6	2	K	<u>A</u>
10. E	<u>♥ 10</u>	♠ J	7	8
11. E	♥ 9	-	-	-

Down 3 — NS -500

**Board 98**  
 East Deals  
 Both Vul

♠ A 9 5	♠ 10 8	♠ K 7
♥ A K J 9 5 2	♥ Q 10 7 4	♥ 8 3
♦ K	♦ J 6	♦ A Q 10 9 8 7 5 3
♣ A 6 2	♣ K 10 7 5 3	♣ 8

♠ Q J 6 4 3 2
♥ 6
♦ 4 2
♣ Q J 9 4

EW 7N; EW 7♦; EW 5♥; EW 1♠; NS 1♣; Par -2220

West	North	East	South
<i>carlosp</i>	<i>BridgeGoth</i>	<i>hectorc</i>	<i>jec</i>
		5♦	Pass
7♦	Pass	Pass	7♠
Pass	Pass	Dbl	Pass
Pass	Pass		

7♠× by South

Trick	Lead	2nd	3rd	4th
1. W	♦ K	6	<u>A</u>	2
2. E	♣ 8	4	<u>A</u>	3
3. W	♣ 6	5	<u>♠ 7</u>	Q
4. E	♥ 8	6	<u>K</u>	4
5. W	♣ 2	7	<u>♠ K</u>	9
6. E	♦ Q	4	♥ 2	J
7. E	♥ 3	<u>♠ J</u>	9	7
8. S	♠ 2	5	<u>8</u>	♦ 3
9. N	♠ 10	♦ 5	3	<u>A</u>
10. W	♥ A	10	♦ 7	<u>♠ 4</u>
11. S	<u>♠ Q</u>	9	♥ Q	♦ 8
12. S	♣ J	♥ 5	<u>K</u>	♦ 9
13. N	♣ 10	♦ 10	<u>♠ 6</u>	♥ J

Down 7 — NS -2000

**Board 102**  
 East Deals  
 None Vul

♠ K 6 5 2	♠ 9 8	♠ 7 4 3
♥ 8 7	♥ Q J 9 3	♥ A K 10 5 4 2
♦ 7 6 4	♦ Q J 8 2	♦ 9 5 3
♣ Q 10 5 3	♣ J 7 2	♣ A

N
W    E
S

♠ A Q J 10
♥ 6
♦ A K 10
♣ K 9 8 6 4

N 2N; NS 3♦; NS 3♣; S 1N; NS 1♠; N 1♥; Par +120

West	North	East	South
<i>carlosp</i>	<i>BridgeGoth</i>	<i>hectorc</i>	<i>jec</i>
Pass	1 NT	1 ♥	Dbl
Pass	3 NT	Pass	2 ♣
Dbl	Pass	Pass	Pass

3 NT× by North

Trick	Lead	2nd	3rd	4th
1. E	♠ 7	10	<u>K</u>	8
2. W	♥ 8	J	<u>K</u>	6
3. E	♠ 4	<u>J</u>	2	9
4. S	<u>♠ A</u>	5	♥ 3	3
5. S	<u>♠ Q</u>	6	♣ 2	♥ 2
6. S	<u>♦ A</u>	6	2	5
7. S	<u>♦ K</u>	4	8	3
8. S	♦ 10	7	<u>Q</u>	9
9. N	♦ J	♥ 4	♣ 4	♣ 3
10. N	♣ 7	<u>A</u>	6	5
11. E	♥ 5	♣ 8	7	<u>9</u>
12. N	♣ J	♥ 10	<u>K</u>	10
13. S	♣ 9	Q	♥ Q	♥ A

Made 3 — NS +550

**Board 106**  
 East Deals  
 N-S Vul

♠ 10 4 2	♠ K Q J 9 7 6	♠ A 8 5 3
♥ 10 3	♥ K 9 5	♥ A 8 6
♦ K Q 8 7 6 5 4	♦ 10 2	♦ A 9
♣ K	♣ 9 3	♣ A Q J 5

N	
W	E
S	

♠ —
♥ Q J 7 4 2
♦ J 3
♣ 10 8 7 6 4 2

EW 7N; E 7♦; W 6♦; EW 3♠; E 1♥; EW 1♣; Par -1520

West	North	East	South	
<i>carlosp</i>	<i>BridgeGoth</i>	<i>hectorc</i>	<i>jec</i>	
		1 ♣	Pass	
1 ♦	1 ♠	2 NT	Pass	
3 ♦	Pass	3 NT	Pass	
4 ♦	Pass	4 ♥	Pass	
5 ♦	Pass	Pass	Pass	
5 ♦ by West				
<i>Trick</i>	<i>Lead</i>	<i>2nd</i>	<i>3rd</i>	<i>4th</i>
1. N	♠ K	A	♦ 3	4
2. S	♦ J	♠ K	2	9
Made 6 — NS -420				

**Board 114**  
 East Deals  
 Both Vul

	♠ A K Q J		
	♥ 9 7 2		
	♦ Q J 8 7 6 5		
	♣ —		
♠ 10 6 3 2 ♥ A 8 ♦ K 10 ♣ A 10 8 4 3	<div style="display: inline-block; background-color: green; color: white; padding: 5px; border: 1px solid black;">           N            W     E            S         </div>	♠ 5 4 ♥ Q J 10 4 3 ♦ A 9 4 ♣ 9 5 2	
	♠ 9 8 7		
	♥ K 6 5		
	♦ 3 2		
	♣ K Q J 7 6		

EW 1N; NS 2♦; EW 2♣; NS 1♠; EW 1♥; Par +90

West	North	East	South
<i>lmb2</i>	<i>BridgeGoth</i>	<i>naninga</i>	<i>jec</i>
		Pass	Pass
1 ♣	1 ♦	Dbl <sup>1</sup>	Pass
1 ♠	Pass	2 ♣	Pass
Pass	2 ♦	Pass	Pass
Pass			

1. 4+h

2 ♦ by North

<i>Trick</i>	<i>Lead</i>	<i>2nd</i>	<i>3rd</i>	<i>4th</i>
1. E	♥ <u>Q</u>	5	8	2
2. E	♥ <u>J</u>	6	<u>A</u>	7
3. W	♠ 3	<u>A</u>	4	7
4. N	♦ <u>Q</u>	<u>A</u>	2	10
5. E	♥ 4	K	♦ <u>K</u>	9
6. W	♠ 2	<u>K</u>	5	8
7. N	♦ <u>J</u>	4	3	♣ 8
8. N	♦ 8	<u>9</u>	♣ 6	♣ 3

Made 2 — NS +90

**Board 116**  
 West Deals  
 N-S Vul

♠ Q J 8 5 ♥ A K 6 ♦ 10 9 5 3 ♣ Q 9	♠ 9 4 ♥ 7 5 3 2 ♦ Q 6 4 2 ♣ K 10 3		♠ 10 6 3 ♥ 4 ♦ J 7 ♣ A J 8 7 6 5 2
♠ A K 7 2 ♥ Q J 10 9 8 ♦ A K 8 ♣ 4			

NS 4♥; EW 1N; NS 2♦; EW 2♣; N 1♠; Par +500; EW 4N×-3;  
 EW 5♣×-3

West	North	East	South
<i>lmb2</i>	<i>BridgeGoth</i>	<i>naninga</i>	<i>jec</i>
1 ♣	Pass	3 ♣ <sup>1</sup>	Dbl
Pass	3 ♥	4 ♣	4 ♥
Pass	Pass	Pass	

1. inv

4 ♥ by North

<i>Trick</i>	<i>Lead</i>	<i>2nd</i>	<i>3rd</i>	<i>4th</i>
1. E	♦ J	<u>A</u>	3	2
2. S	♠ A	5	4	6
3. S	♠ K	8	9	3
4. S	♠ 2	Q	♥ 5	10
5. N	♦ 4	7	<u>K</u>	5
6. S	♠ 7	J	♥ 7	♣ 2
7. N	♥ 2	4	8	<u>K</u>
8. W	♦ 10	<u>Q</u>	♣ 5	8
9. N	♥ 3	♣ 6	Q	<u>A</u>
10. W	♣ 9	-	-	-

Made 4 — NS +620

**Board 120**  
 West Deals  
 Both Vul

♠ K Q 10 6 4	♠ J 9 7 5	♠ 8 3
♥ J 6	♥ A K 10 7 4	♥ 8
♦ A J 10 7	♦ K 5	♦ Q 9 8 6 2
♣ 8 7	♣ A K	♣ J 10 6 4 3

♠ A 2
♥ Q 9 5 3 2
♦ 4 3
♣ Q 9 5 2

NS 5♥; NS 4N; EW 2♦; NS 2♣; NS 1♠; Par +650

West	North	East	South
<i>Spooky</i>	<i>smispi</i>	<i>Wild card</i>	<i>jec</i>
1 ♠	2 ♥	Pass	4 ♥
Pass	Pass	Pass	

4 ♥ by North

<i>Trick</i>	<i>Lead</i>	<i>2nd</i>	<i>3rd</i>	<i>4th</i>
1. E	♠ 8	<u>A</u>	4	5
2. S	♥ 2	6	<u>A</u>	8
3. N	<u>♥ K</u>	♣ 6	3	J
4. N	<u>♣ A</u>	3	2	7
5. N	<u>♣ K</u>	4	5	8
6. N	♥ 4	♦ 9	<u>Q</u>	♠ 6
7. S	<u>♣ Q</u>	♦ 7	♦ 5	10
8. S	♠ 2	<u>Q</u>	7	3
9. W	♦ A	-	-	-

Made 5 — NS +650



**Board 126**  
 East Deals  
 Both Vul

♠ K Q 9 6 5 2	♠ J	♠ 10 4
♥ J 9	♥ K 8 7 5 2	♥ A Q 10 6 3
♦ J 9	♦ 10 8 6 5 3	♦ K 2
♣ 9 8 4	♣ Q 2	♣ A K J 3
	♠ A 8 7 3	
	♥ 4	
	♦ A Q 7 4	
	♣ 10 7 6 5	

E 4♠; W 3♠; E 2N; NS 3♦; W 1N; EW 1♥; EW 1♣; Par -500:  
 NS 5♦×-2

West	North	East	South
<i>Spooky</i>	<i>smispi</i>	<i>Wild card</i>	<i>jec</i>
		1♥	Dbl
2♠ <sup>1</sup>	Pass	3NT	Pass
Pass	Pass		

1. weak

3NT by East

<i>Trick</i>	<i>Lead</i>	<i>2nd</i>	<i>3rd</i>	<i>4th</i>
1. S	♦ 4	J	8	2
2. W	♥ J	5	3	4
3. W	♥ 9	2	<u>10</u>	♠ 8
4. E	♠ 4	3	<u>K</u>	J
5. W	♣ 4	2	<u>A</u>	6
6. E	♠ 10	<u>A</u>	2	♥ 7
7. S	♦ A	9	6	K
8. S	♦ Q	♠ 5	5	♥ 6
9. S	♦ 7	♠ 6	<u>10</u>	♥ Q
10. N	♦ 3	♣ 3	♠ 7	♠ 9
11. N	♣ Q	-	-	-

Down 1 — NS +100

**Board 128**  
 West Deals  
 N-S Vul

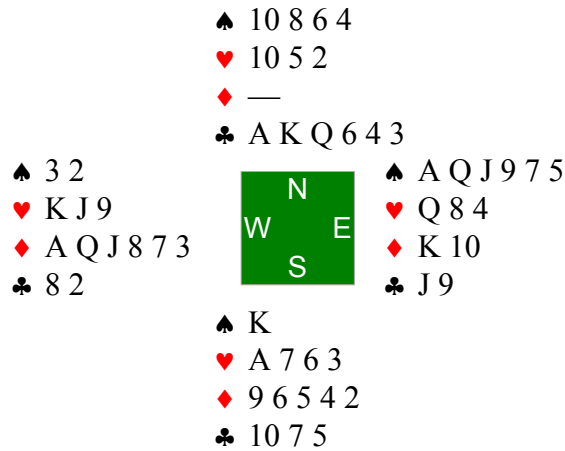

W 3♠; E 2♠; EW 3♦; NS 3♣; EW 1♥; Par -140

West	North	East	South
<i>Spooky</i>	<i>smispi</i>	<i>Wild card</i>	<i>jec</i>
1 ♦ <sup>1</sup>	2 ♣	2 ♥ <sup>2</sup>	3 ♣
Pass	Pass	4 ♠	Pass
Pass	Pass		

1. 5+♠ or 4441♣

2. spades

4 ♠ by East

<i>Trick</i>	<i>Lead</i>	<i>2nd</i>	<i>3rd</i>	<i>4th</i>
1. S	♣ 5	2	<u>K</u>	9
2. N	<u>♣ A</u>	J	10	8
3. N	♥ 2	4	<u>A</u>	9
4. S	♦ 2	A	<u>♠ 4</u>	K
5. N	♥ 10	8	3	<u>J</u>
6. W	♠ 2	8	J	<u>K</u>
7. S	♦ 9	3	<u>♠ 6</u>	10
8. N	♥ 5	Q	7	<u>K</u>

Down 3 — NS +150

**Board 130**  
 East Deals  
 None Vul

♠ 4 3	♠ A K 10 8 7 2	♠ 6
♥ K 10 2	♥ 7	♥ A J 8 5 3
♦ Q J 9 3	♦ A 4	♦ K 10 7 2
♣ A K 9 8	♣ Q 10 5 4	♣ J 7 2

♠ Q J 9 5
♥ Q 9 6 4
♦ 8 6 5
♣ 6 3

NS 3♠; EW 3♥; EW 4♦; EW 3♣; NS 1N; Par -100: NS 4♠×-1

West	North	East	South
<i>Spooky</i>	<i>smispi</i>	<i>Wild card</i>	<i>jec</i>
		Pass	Pass
1 ♣ <sup>1</sup>	1 ♠	2 ♥	3 ♠
Pass	4 ♠	Pass	Pass
Pass			

1. 2+♣

4 ♠ by North

<i>Trick</i>	<i>Lead</i>	<i>2nd</i>	<i>3rd</i>	<i>4th</i>
1. E	♣ 2	3	<u>K</u>	4
2. W	♦ 3	<u>A</u>	2	5
3. N	♥ 7	8	9	<u>10</u>
4. W	♦ <u>Q</u>	4	7	6
5. W	♣ A	-	-	-

Down 1 — NS -50

**Board 131**  
 South Deals  
 N-S Vul

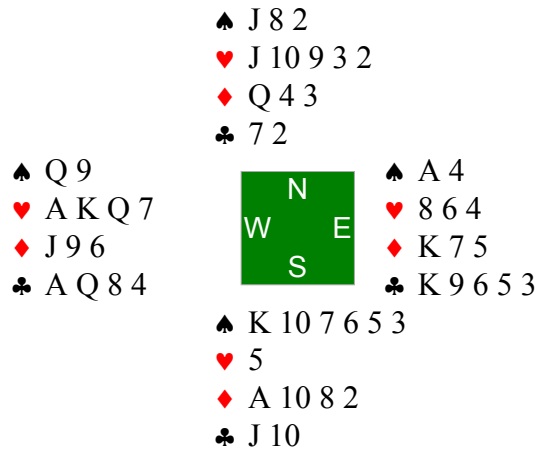

E 4N; W 3N; EW 4♣; EW 2♥; E 2♦; NS 1♠; W 1♦; Par -430

West	North	East	South
<i>Spooky</i>	<i>smispi</i>	<i>Wild card</i>	<i>jec</i>
			Pass
1 ♣ <sup>1</sup>	Pass	2 ♣ <sup>2</sup>	2 ♠
Pass <sup>3</sup>	Pass	2 NT	Pass
4 NT	Pass	Pass	Pass

1. 2+♣

2. 10+, 5+C

3. forcing

4 NT by East

Trick	Lead	2nd	3rd	4th
1. S	♦ 2	6	Q	<u>K</u>
2. E	<u>♣ K</u>	J	4	2
3. E	♦ 5	<u>A</u>	9	4
4. S	♣ 10	<u>A</u>	7	3
5. W	♥ A	2	4	5
6. W	♥ K	3	6	♠ 3
7. W	♦ J	3	7	8

Made 5 — NS -460

**Board 132**  
 West Deals  
 E-W Vul

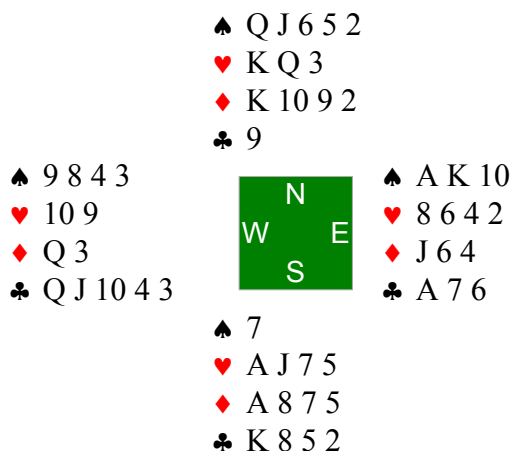

NS 3♥; NS 4♦; NS 2N; NS 2♠; Par +140

West	North	East	South
<i>Spooky</i>	<i>smispi</i>	<i>Wild card</i>	<i>jec</i>
Pass	Pass	1 ♣	Pass
1 ♦ <sup>1</sup>	1 ♠	Pass	Pass
2 ♣	2 ♦	Pass	3 ♦
Pass	Pass	Pass	

1. 0-6 any, 8-11 nat, 0-10 4♥-4♠,

3♦ by North

<i>Trick</i>	<i>Lead</i>	<i>2nd</i>	<i>3rd</i>	<i>4th</i>
1. E	♥ 4	5	9	<u>Q</u>
2. N	♠ J	<u>K</u>	7	3
3. E	♥ 2	7	10	<u>K</u>
4. N	♠ 2	10	<u>♦ 5</u>	4
5. S	<u>♦ A</u>	3	2	4
6. S	♦ 7	Q	<u>K</u>	6
7. N	♠ 5	A	<u>♦ 8</u>	8
8. S	<u>♥ A</u>	♣ Q	3	6
9. S	<u>♥ J</u>	♣ 3	♣ 9	8

Made 5 — NS +150

**Board 134**  
 East Deals  
 N-S Vul

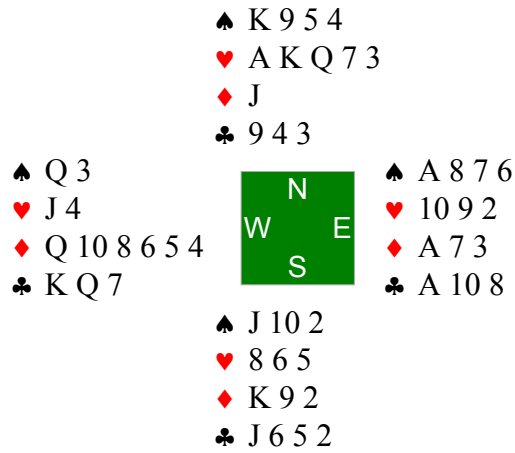

EW 3♦; NS 1♠; NS 1♥; NS 1♣; Par -110

West	North	East	South
<i>Spooky</i>	<i>smispi</i>	<i>Wild card</i>	<i>jec</i>
		1♣	Pass
1♦ <sup>1</sup>	1♥	Pass	2♥
3♦	3♥	Pass	Pass
Pass			

1. 0-6 any, 0-10 4♥-4♠, 8+ nat

3♥ by North

<i>Trick</i>	<i>Lead</i>	<i>2nd</i>	<i>3rd</i>	<i>4th</i>
1. E	<u>♦ A</u>	2	4	J
2. E	<u>♠ 7</u>	2	Q	<u>K</u>
3. N	<u>♥ A</u>	2	5	4
4. N	<u>♥ K</u>	9	6	J
5. N	<u>♥ Q</u>	10	8	♦ 5
6. N	<u>♠ 5</u>	<u>A</u>	10	3
7. E	<u>♠ 6</u>	<u>J</u>	♦ 6	4
8. S	♦ K	8	-	-

Made 3 — NS +140

**Board 140**  
 West Deals  
 Both Vul

♠ K 10 ♥ K Q 10 7 6 ♦ A 6 2 ♣ A K 2		♠ A Q 6 4 ♥ A J ♦ 10 9 8 4 ♣ Q 9 4	♠ J 9 5 3 2 ♥ 9 2 ♦ 5 ♣ J 10 8 6 3
		♠ 8 7 ♥ 8 5 4 3 ♦ K Q J 7 3 ♣ 7 5	

NS 2N; EW 2♠; NS 3♦; EW 3♣; W 1♥; Par +110

West	North	East	South
<i>faramarz</i>	<i>smispi</i>	<i>Harmon</i>	<i>jec</i>
1 ♥	Dbl	Pass	2 ♦
2 NT	Pass	Pass	Pass

2 NT by West

<i>Trick</i>	<i>Lead</i>	<i>2nd</i>	<i>3rd</i>	<i>4th</i>
1. N	<u>♦ 10</u>	5	7	2
2. N	♦ 9	♠ 2	<u>J</u>	6
3. S	♦ Q	<u>A</u>	8	♠ 3
4. W	♥ K	<u>A</u>	2	3
5. N	♦ 4	♣ 3	<u>K</u>	♥ 6
6. S	<u>♦ 3</u>	♥ 7	♠ 6	♥ 9
7. S	♠ 8	10	<u>Q</u>	5
8. N	♠ <u>A</u>	9	7	K
9. N	♥ J	♣ 6	4	<u>Q</u>
10. W	♥ <u>10</u>	♠ 4	♠ J	5
11. W	♣ <u>A</u>	4	8	7
12. W	♣ <u>K</u>	9	10	5
13. W	♣ 2	<u>Q</u>	J	♥ 8

Down 3 — NS +300

**Board 144**  
 West Deals  
 None Vul

♠ J ♥ A Q 8 7 3 ♦ K 10 7 4 ♣ A 5 2		♠ K 10 7 6 5 4 2 ♥ K 10 5 2 ♦ 6 3 ♣ —	♠ A 9 3 ♥ 4 ♦ A 5 ♣ Q J 10 9 8 7 6
♠ Q 8 ♥ J 9 6 ♦ Q J 9 8 2 ♣ K 4 3			

EW 6♣; EW 5N; EW 2♥; EW 3♦; NS 1♠; Par -920

West	North	East	South
<i>faramarz</i>	<i>smispi</i>	<i>Harmon</i>	<i>jec</i>
1 ♥	3 ♠	3 NT	Pass
Pass	Pass		

3 NT by East

<i>Trick</i>	<i>Lead</i>	<i>2nd</i>	<i>3rd</i>	<i>4th</i>
1. S	<u>♠ Q</u>	J	7	3
2. S	♠ 8	♥ 3	10	<u>A</u>
3. E	♣ Q	K	<u>A</u>	♥ 5
4. W	<u>♥ A</u>	2	4	6
5. W	♣ 2	♥ 10	<u>J</u>	4
6. E	<u>♣ 10</u>	3	5	♠ 6
7. E	<u>♣ 9</u>	♥ J	♦ 4	♠ 4
8. E	♣ 8	♦ 9	♥ 7	♦ 3
9. E	<u>♣ 7</u>	♦ 2	♥ 8	♠ 2
10. E	<u>♣ 6</u>	♥ 9	♥ Q	♠ 5
11. E	<u>♦ A</u>	8	7	6
12. E	♦ 5	J	<u>K</u>	♠ K
13. W	♦ 10	♥ K	♠ 9	<u>Q</u>

Made 5 — NS -460



**Board 146**  
 East Deals  
 Both Vul

♠ 7 6	♠ J 8 4	♠ Q 5
♥ Q J 8 2	♥ 6	♥ 10 9 7 3
♦ 9 5	♦ J 10 8 6 4 3 2	♦ K Q
♣ J 8 5 3 2	♣ 9 7	♣ A Q 10 6 4

N	
W	E
S	

♠ A K 10 9 3 2
♥ A K 5 4
♦ A 7
♣ K

NS 5♠; NS 5♦; NS 2N; EW 1♥; Par +650

West	North	East	South
<i>faramarz</i>	<i>smispi</i>	<i>Harmon</i>	<i>jec</i>
		1 ♣	Dbl
2 ♣	Pass	Pass	3 ♣
Pass	3 ♦	Pass	3 ♠
Pass	4 ♠	Pass	Pass
Pass			

4 ♠ by South

Trick	Lead	2nd	3rd	4th
1. W	♣ 2	7	Q	<u>K</u>
2. S	♥ A	8	6	3
3. S	♥ 4	2	<u>♠ 4</u>	7
4. N	♣ 9	A	<u>♠ 2</u>	3
5. S	♥ 5	J	<u>♠ 8</u>	9
6. N	♠ J	Q	-	-

Made 6 — NS +680

**Board 150**  
 East Deals  
 N-S Vul

♠ 10 9 8 ♥ A 8 6 ♦ A 7 6 5 ♣ K 6 3		♠ A Q 3 2 ♥ K Q 4 2 ♦ Q 9 3 ♣ 7 2	♠ J 7 4 ♥ J 3 ♦ K J 8 2 ♣ 10 9 8 5
♠ K 6 5 ♥ 10 9 7 5 ♦ 10 4 ♣ A Q J 4			

NS 3♥; NS 2♠; NS 1N; EW 1♦; NS 1♣; Par +140

West	North	East	South
<i>OosmanB</i>	<i>BridgeGoth</i>	<i>zain_mk</i>	<i>jec</i>
		Pass	Pass
1♦	Pass	1NT	Pass
Pass	Dbl	Pass	2♥
Pass	Pass	Pass	

2♥ by South

<i>Trick</i>	<i>Lead</i>	<i>2nd</i>	<i>3rd</i>	<i>4th</i>
1. W	♥ 6	<u>Q</u>	3	5
2. N	♣ 2	8	Q	<u>K</u>
3. W	♥ <u>A</u>	2	J	7
4. W	♥ 8	4	♦ 8	<u>9</u>
5. S	♦ 4	7	9	<u>J</u>
6. E	♦ 2	10	<u>A</u>	3
7. W	♠ 10	2	4	<u>K</u>
8. S	♣ <u>A</u>	3	7	5
9. S	♣ <u>J</u>	6	♦ Q	9
10. S	♠ 5	8	<u>A</u>	7
11. N	♠ <u>Q</u>	J	6	9
12. N	♠ 3	♦ K	-	-

Made 3 — NS +140

**Board 151**  
 South Deals  
 E-W Vul

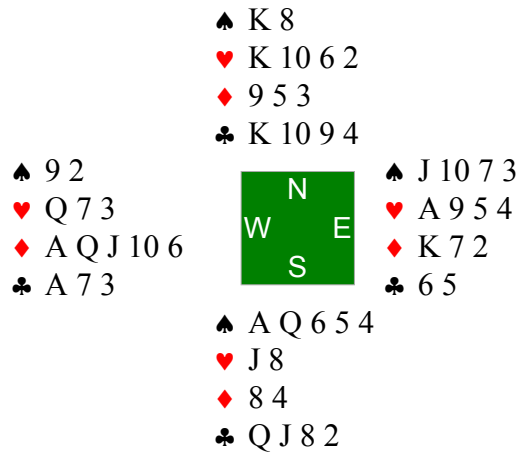

NS 2♠; NS 3♣; EW 1N; EW 2♦; EW 1♥; Par +110

West	North	East	South
<i>OosmanB</i>	<i>BridgeGoth</i>	<i>zain_mk</i>	<i>jec</i>
			Pass
1 ♦	Pass	1 ♥	Dbl
Rdbl <sup>1</sup>	2 ♣	Pass	Pass
2 ♦	3 ♣	Pass	Pass
Pass			

1. support

3 ♣ by North

<i>Trick</i>	<i>Lead</i>	<i>2nd</i>	<i>3rd</i>	<i>4th</i>
1. E	♦ 2	4	<u>A</u>	3
2. W	♥ 3	2	<u>A</u>	J
3. E	♦ <u>K</u>	8	Q	5
4. E	♥ 4	8	Q	<u>K</u>
5. N	♣ 10	5	2	<u>A</u>
6. W	♣ 3	4	6	<u>8</u>
7. S	♣ J	7	-	-

Made 3 — NS +110

**Board 152**  
West Deals  
Both Vul

♠ Q 8 5 4 2	♠ K J 10 3	♠ —
♥ J 9 6 5 4	♥ 7	♥ K Q 10 8 2
♦ 6 4	♦ Q 8 5 2	♦ A K 7
♣ A	♣ K 9 7 6	♣ J 10 5 3 2

♠ A 9 7 6
♥ A 3
♦ J 10 9 3
♣ Q 8 4

EW 5♥; NS 2♠; NS 1♦; Par -650

West	North	East	South
<i>OosmanB</i>	<i>BridgeGoth</i>	<i>zain_mk</i>	<i>jec</i>
Pass	Pass	1♥	Dbl
4♥	4♠	5♥	Pass
Pass	Pass		

5♥ by East

<i>Trick</i>	<i>Lead</i>	<i>2nd</i>	<i>3rd</i>	<i>4th</i>
1. S	♦ J	4	8	<u>A</u>
2. E	♣ 2	4	<u>A</u>	6
3. W	♦ 6	2	<u>K</u>	3
4. E	♣ 3	8	<u>♥ 4</u>	7
5. W	♠ 2	10	<u>♥ 2</u>	6
6. E	♣ 5	Q	<u>♥ 5</u>	9
7. W	♠ 4	3	<u>♥ 8</u>	7
8. E	♦ 7	10	<u>♥ 6</u>	5
9. W	♠ 5	J	<u>♥ 10</u>	A
10. E	♣ 10	♠ 9	<u>♥ 9</u>	K
11. W	♠ 8	K	♥ K	<u>♥ A</u>
12. S	♥ 3	J	7	<u>Q</u>
13. E	♣ J	♦ 9	♠ Q	♦ Q

Made 6 — NS -680

**Board 153**  
 North Deals  
 N-S Vul

♠ A 10 8 4 2	♠ K Q 9 5	♠ 6
♥ K Q J 9 5	♥ —	♥ A 8 7 4 3 2
♦ K Q	♦ 10 8 6 5 4 3 2	♦ A
♣ 9	♣ K 8	♣ A 10 7 6 3
	<div style="display: inline-block; border: 1px solid black; background-color: #006400; color: white; padding: 5px; text-align: center; margin: 5px;">       N        W     E        S     </div>	
	♠ J 7 3	
	♥ 10 6	
	♦ J 9 7	
	♣ Q J 5 4 2	

EW 7♥; EW 4N; EW 4♠; W 3♣; NS 2♦; E 2♣; Par -1510

West	North	East	South
<i>OosmanB</i>	<i>BridgeGoth</i>	<i>zain_mk</i>	<i>jec</i>
	Pass	1 ♥	Pass
4 ♣ <sup>1</sup>	Pass	4 NT	Pass
5 ♠ <sup>2</sup>	Dbl	5 NT	Pass
6 ♦	Pass	7 ♥	Pass
Pass	Pass		

1. splinter

2. 2+q

7 ♥ by East

Trick	Lead	2nd	3rd	4th
1. S	♠ 3	<u>A</u>	5	6
2. W	♥ <u>K</u>	♦ 2	2	6

Made 7 — NS -1510

**Board 169**  
 North Deals  
 N-S Vul

♠ A 3	♠ K J 10 8 6	♠ Q 9 4 2
♥ 9 8 6 3	♥ 10 7 5 4	♥ A K Q 2
♦ 10 8 7 6	♦ Q J	♦ A K 9
♣ 5 4 2	♣ Q 7	♣ 8 3

♠ 7 5	♠ 7 5
♥ J	♥ J
♦ 5 4 3 2	♦ 5 4 3 2
♣ A K J 10 9 6	♣ A K J 10 9 6

EW 3♥; EW 3♦; EW 1N; EW 1♠; NS 1♣; Par -140

West	North	East	South
<i>OosmanB</i>	<i>BridgeGoth</i>	<i>zain_mk</i>	<i>jec</i>
	Pass	1♦	2♣
Pass	2♠	Pass	3♣
Pass	Pass	Pass	

3♣ by South

<i>Trick</i>	<i>Lead</i>	<i>2nd</i>	<i>3rd</i>	<i>4th</i>
1. W	♦ 8	J	<u>K</u>	3
2. E	♣ 3	<u>J</u>	4	7
3. S	♠ 5	3	10	<u>Q</u>
4. E	<u>♦ A</u>	5	6	Q
5. E	<u>♥ A</u>	J	3	4
6. E	♥ Q	<u>♣ 6</u>	6	5
7. S	♠ 7	<u>A</u>	6	2
8. W	♣ 2	<u>Q</u>	8	9
9. N	♠ K	4	♦ 2	<u>♣ 5</u>
10. W	♦ 7	♥ 7	<u>9</u>	4
11. E	♥ K	-	-	-

Down 3 — NS -300

**Board 172**  
 West Deals  
 None Vul

♠ K 9 6 3 2	♠ A J 8	♠ 10 7
♥ Q 8 6	♥ J 10 9 4 2	♥ 7 5 3
♦ A J	♦ 10 6	♦ K Q 4
♣ A 8 7	♣ K 6 4	♣ Q 10 9 3 2
	<div style="display: inline-block; background-color: green; color: white; padding: 5px; text-align: center; margin: 5px;">           N            W     E            S         </div>	
	♠ Q 5 4	
	♥ A K	
	♦ 9 8 7 5 3 2	
	♣ J 5	

NS 3♦; EW 1N; NS 1♠; NS 1♥; EW 1♣; Par +110

West	North	East	South
<i>OosmanB</i>	<i>BridgeGoth</i>	<i>zain_mk</i>	<i>jec</i>
1 ♠	Pass	1 NT	Pass
2 ♣	Pass	Pass	2 ♦
Pass	Pass	3 ♣	Pass
Pass	Pass		

3 ♣ by West

Trick	Lead	2nd	3rd	4th
1. N	♦ 10	4	5	<u>A</u>
2. W	♦ J	6	<u>Q</u>	2
3. E	♦ K	3	♥ 6	<u>♣ 4</u>
4. N	♥ J	3	<u>K</u>	8
5. S	<u>♥ A</u>	Q	9	5
6. S	♠ 4	K	<u>A</u>	7
7. N	<u>♠ J</u>	10	5	2
8. N	♥ 2	7	♣ J	<u>♣ A</u>
9. W	♣ 8	<u>K</u>	2	5

Down 2 — NS +100

**Board 175**  
 South Deals  
 None Vul

♠ K 8 2 ♥ Q J 9 7 ♦ A 7 6 3 ♣ A 7		♠ J 9 5 ♥ A 10 8 6 ♦ K J 8 4 ♣ Q 8	♠ A Q 7 4 3 ♥ 4 2 ♦ 10 9 5 ♣ J 5 3
		♠ 10 6 ♥ K 5 3 ♦ Q 2 ♣ K 10 9 6 4 2	

S 2♥; NS 3♣; EW 1N; EW 1♠; N 1♥; EW 1♦; Par +110

West	North	East	South
<i>OosmanB</i>	<i>BridgeGoth</i>	<i>zain_mk</i>	<i>jec</i>
			Pass
1♦	Pass	1♠	2♣
Dbl <sup>1</sup>	Pass	2♠	Pass
Pass	Pass		

1. 3♠

2♠ by East

<i>Trick</i>	<i>Lead</i>	<i>2nd</i>	<i>3rd</i>	<i>4th</i>
1. S	♦ 2	3	<u>K</u>	5
2. N	♣ Q	5	6	<u>A</u>
3. W	♣ 7	<u>8</u>	3	4
4. N	♦ 4	9	Q	<u>A</u>
5. W	♦ 6	8	10	<u>♠ 6</u>
6. S	♣ K	♠ 2	<u>♠ 5</u>	J
7. N	♦ J	<u>♠ Q</u>	♣ 2	7
8. E	♠ 4	10	<u>K</u>	J
9. W	♠ 8	9	<u>A</u>	♥ 3

Down 1 — NS +50



**Board 176**  
 West Deals  
 N-S Vul

♠ A K Q 3	♠ J 8 7 4	♠ 10 6
♥ 10 8 3	♥ 7 5	♥ J 9 4 2
♦ 9 5	♦ K J 10 6 2	♦ Q 8
♣ A J 8 4	♣ Q 3	♣ K 10 9 7 2

♠ 9 5 2	♠ A K Q 6
♥ A K Q 6	♥ A 7 4 3
♦ A 7 4 3	♣ 6 5

NS 2♦; EW 2♣; EW 1♠; NS 1♥; Par +90

West	North	East	South
<i>OosmanB</i>	<i>BridgeGoth</i>	<i>zain_mk</i>	<i>jec</i>
1 ♣	Pass	Pass	Dbl
Pass	1 ♦	2 ♣	Pass
Pass	2 ♠	Pass	3 ♦
Pass	Pass	Pass	

3 ♦ by North

<i>Trick</i>	<i>Lead</i>	<i>2nd</i>	<i>3rd</i>	<i>4th</i>
1. E	♣ 7	5	<u>A</u>	3
2. W	<u>♠ A</u>	7	10	2
3. W	<u>♠ K</u>	4	6	5
4. W	<u>♠ Q</u>	8	♣ 2	9
5. W	♣ 4	Q	<u>K</u>	6
6. E	♥ 2	<u>A</u>	3	5
7. S	<u>♦ A</u>	5	2	8
8. S	♦ 3	9	J	<u>Q</u>
9. E	♥ 4	-	-	-

Down 2 — NS -200

**Board 184**  
 West Deals  
 None Vul

♠ Q 3 ♥ A K Q 9 8 ♦ J 7 ♣ 10 8 5 2		♠ 10 9 7 6 2 ♥ — ♦ K 10 5 2 ♣ K J 7 6	♠ 8 ♥ J 7 2 ♦ Q 8 6 4 ♣ A Q 9 4 3
		♠ A K J 5 4 ♥ 10 6 5 4 3 ♦ A 9 3 ♣ —	

NS 5♠; W 2♥; NS 3♦; W 2♣; E 1♥; E 1♣; Par +450

West	North	East	South
<i>Harmon</i>	<i>nevaio</i>	<i>canalla</i>	<i>jec</i>
1 ♥	Pass	2 ♥	2 ♠
Pass	4 ♥	Pass	6 ♠
Pass	Pass	Pass	

6 ♠ by South

<i>Trick</i>	<i>Lead</i>	<i>2nd</i>	<i>3rd</i>	<i>4th</i>
1. W	♥ A	♠ 2	2	3
2. N	♣ 6	Q	♠ 4	2
3. S	♥ 4	8	♠ 6	7
4. N	♣ K	4	♦ 3	5
5. N	♣ 7	9	♠ 5	8
6. S	♦ A	7	2	4
7. S	♦ 9	J	K	6
8. N	♦ 5	8	♠ J	♠ Q
9. W	♠ 3	7	8	A
10. S	♥ 5	9	♠ 9	J
11. N	♦ 10	Q	♠ K	♥ K
12. S	♥ 6	Q	♠ 10	♣ 3
13. N	♣ J	A	♥ 10	10

Down 1 — NS -50

**Board 190**  
 East Deals  
 None Vul

♠ K Q	<div style="display: inline-block; background-color: green; color: white; padding: 10px; border: 1px solid black;">           N W     E S         </div>	♠ A 10 7 5 4
♥ 7 4		♥ A J 6 5 2
♦ Q J 10 9 6		♦ 3
♣ 9 8 3 2		♣ A 5
♠ 9 8		♠ J 6 3 2
♥ 10 8	♥ K Q 9 3	
♦ A 7 5	♦ K 8 4 2	
♣ K Q J 10 6 4	♣ 7	

EW 2♠; EW 2♥; NS 1N; EW 1♦; NS 1♣; Par -100; NS 2N×-1

West	North	East	South
<i>Harmon</i>	<i>nevaio</i>	<i>canalla</i>	<i>jec</i>
		1 ♠	Pass
1 NT	Pass	2 ♥	3 ♣
Pass	Pass	3 ♥	Pass
3 ♠	Pass	Pass	Pass

3 ♠ by East

Trick	Lead	2nd	3rd	4th
1. S	♣ K	2	7	<u>A</u>
2. E	♦ 3	5	9	<u>K</u>
3. N	♦ 2	♣ 5	<u>A</u>	6
4. S	♣ Q	3	♦ 4	<u>♠ 4</u>
5. E	<u>♥ A</u>	8	4	3
6. E	♥ 2	<u>10</u>	7	9
7. S	♣ J	8	♦ 8	<u>♠ 5</u>
8. E	♥ 5	♦ 7	<u>♠ Q</u>	Q
9. W	♣ 9	♠ 6	<u>♠ 7</u>	4
10. E	♥ 6	♣ 6	<u>♠ K</u>	K
11. W	♦ Q	♠ 2	<u>♠ 10</u>	♣ 10
12. E	<u>♠ A</u>	8	♦ 10	3
13. E	♥ J	♠ 9	♦ J	<u>♠ J</u>

Made 3 — NS -140

**Board 192**  
 West Deals  
 E-W Vul

♠ 10 8 7	<div style="display: inline-block; background-color: green; color: white; padding: 10px; border: 1px solid black;">           N W     E S         </div>	♠ Q
♥ 10 6 3		♥ J 9 8 7
♦ Q J 8 6 4		♦ A K 5 3
♣ J 9		♣ A 10 6 3
♠ A K 9 5 4 3 2		♠ J 6
♥ Q	♥ A K 5 4 2	
♦ 10 7 2	♦ 9	
♣ K 4	♣ Q 8 7 5 2	

NS 4♠; NS 1N; EW 2♦; NS 2♣; NS 1♥; Par +420

West	North	East	South
<i>Harmon</i>	<i>nevaio</i>	<i>canalla</i>	<i>jec</i>
Pass	Pass	1 ♣	1 ♠
Pass	2 ♥	Pass	2 ♠
Pass	Pass	Pass	

2 ♠ by South

<i>Trick</i>	<i>Lead</i>	<i>2nd</i>	<i>3rd</i>	<i>4th</i>
1. W	♣ J	2	6	<u>K</u>
2. S	♥ Q	3	2	7
3. S	♦ 10	<u>Q</u>	9	5
4. W	♣ 9	5	<u>10</u>	4
5. E	♣ 3	♦ 2	<u>♠ 7</u>	7
6. W	♠ 8	6	<u>Q</u>	<u>A</u>
7. S	♦ 7	4	<u>♠ J</u>	3
8. N	♥ 4	J	<u>♠ 4</u>	6
9. S	<u>♠ K</u>	10	♥ 5	♥ 9
10. S	♠ 9	♥ 10	-	-

Made 4 — NS +170

**Board 196**  
 West Deals  
 Both Vul

♠ 8	♠ 10 7 5 4	♠ A J 6 2
♥ 9 5	♥ A	♥ K 8 6 2
♦ A 9 7 5 4	♦ 8 2	♦ K Q J 3
♣ K J 10 5 4	♣ A Q 9 8 7 2	♣ 6

♠ K Q 9 3	<table border="1" style="background-color: #006400; color: white; width: 40px; height: 40px; margin: auto;"> <tr><td style="text-align: center;">N</td></tr> <tr><td style="text-align: center;">W E</td></tr> <tr><td style="text-align: center;">S</td></tr> </table>	N	W E	S	♠ A J 6 2
N					
W E					
S					
♥ Q J 10 7 4 3		♥ K 8 6 2			
♦ 10 6		♦ K Q J 3			
♣ 3		♣ 6			

EW 4♦; NS 2♠; EW 1N; NS 1♥; W 1♣; Par -130

West	North	East	South
<i>Harmon</i>	<i>nevaio</i>	<i>canalla</i>	<i>jec</i>
Pass	Pass	1♦	2♥
3♦	3♥	Pass	Pass
4♣	Pass	4♦	Pass
Pass	Pass		

4♦ by East

Trick	Lead	2nd	3rd	4th
1. S	♥ Q	5	<u>A</u>	2
2. N	♣ <u>A</u>	6	3	4
3. N	♣ 2	♦ <u>K</u>	♥ 3	5
4. E	♦ <u>Q</u>	6	4	2
5. E	♦ <u>J</u>	10	5	8

Made 5 — NS -150

**Board 198**  
 East Deals  
 E-W Vul

♠ 8 7 4 2 ♥ A K ♦ A J 9 6 3 ♣ 9 5		♠ A K Q ♥ Q 9 6 3 ♦ 8 5 ♣ A J 10 8	♠ J 9 6 ♥ 10 7 5 4 ♦ 7 4 ♣ K Q 7 4
♠ 10 5 3 ♥ J 8 2 ♦ K Q 10 2 ♣ 6 3 2			

NS 1N; EW 1♠; NS 1♥; EW 1♦; S 1♣; Par +90

West	North	East	South
<i>Harmon</i>	<i>nevaio</i>	<i>canalla</i>	<i>jec</i>
		Pass	Pass
1♦	Dbl	Pass	1NT
Pass	2NT	Pass	3NT
Pass	Pass	Pass	

3 NT by South

<i>Trick</i>	<i>Lead</i>	<i>2nd</i>	<i>3rd</i>	<i>4th</i>
1. W	♦ 6	5	7	<u>10</u>
2. S	♣ 2	5	J	<u>K</u>
3. E	♦ 4	K	<u>A</u>	8
4. W	♦ 9	♥ 3	♠ 6	<u>Q</u>
5. S	♣ 3	9	10	<u>Q</u>
6. E	♥ 4	2	<u>K</u>	6
7. W	<u>♦ J</u>	♥ 9	♥ 5	2
8. W	<u>♥ A</u>	Q	7	8
9. W	<u>♦ 3</u>	♣ 8	♣ 4	♠ 3
10. W	♠ 2	-	-	-

Down 3 — NS -150

**Board 199**  
 South Deals  
 Both Vul

♠ Q 8 7 2 ♥ Q J 9 ♦ K ♣ A 8 7 6 4	♠ J 6 ♥ A K 7 2 ♦ Q 10 8 4 2 ♣ J 10	<div style="text-align: center; border: 1px solid black; width: 40px; height: 40px; margin: 0 auto; background-color: #006400; color: white; display: flex; flex-direction: column; align-items: center; justify-content: center;"> <span>N</span> <span>W</span> <span>S</span> <span>E</span> </div>	♠ K 10 4 3 ♥ 10 3 ♦ A 9 6 5 3 ♣ 3 2
♠ A 9 5 ♥ 8 6 5 4 ♦ J 7 ♣ K Q 9 5			

EW 2♠; NS 2♥; NS 1♦; EW 1♣; Par -110

West	North	East	South
<i>Harmon</i>	<i>nevaio</i>	<i>canalla</i>	<i>jec</i>
			Pass
1 ♣	Pass	1 ♠	Pass
2 ♠	Dbl	Pass	3 ♥
Pass	Pass	Pass	

3 ♥ by South

<i>Trick</i>	<i>Lead</i>	<i>2nd</i>	<i>3rd</i>	<i>4th</i>
1. W	♠ 7	6	<u>K</u>	5
2. E	♣ 3	5	<u>A</u>	10
3. W	♠ 2	<u>J</u>	3	9
4. N	<u>♥ A</u>	3	4	9
5. N	<u>♥ K</u>	10	5	J

Down 1 — NS -100

**Board 200**  
 West Deals  
 None Vul

♠ A J 10 9 7 3		♠ K Q 8
♥ 4		♥ 8 7
♦ K 10 2		♦ Q J 8 3
♣ 8 4 3		♣ J 9 6 2
♠ 6 5 2 ♥ A Q 10 5 3 ♦ A 9 5 ♣ Q 7		

NS 5♥; EW 2♠; NS 3♣; NS 1N; Par +450

West	North	East	South
<i>Harmon</i>	<i>nevaio</i>	<i>canalla</i>	<i>jec</i>
2 ♠	Dbl	3 ♠	4 ♥
Pass	Pass	Pass	

4 ♥ by South

<i>Trick</i>	<i>Lead</i>	<i>2nd</i>	<i>3rd</i>	<i>4th</i>
1. W	♦ 2	4	Q	<u>A</u>
2. S	<u>♥ A</u>	4	2	7
3. S	♥ 3	♠ 7	<u>K</u>	8
4. N	♣ 5	2	<u>Q</u>	3
5. S	♣ 7	4	<u>A</u>	6
6. N	<u>♣ K</u>	9	♦ 5	8
7. N	♣ 10	J	<u>♥ 5</u>	♠ 3

Made 5 — NS +450



**Board 202**  
 East Deals  
 Both Vul

♠ A 10 5		♠ 9 6
♥ A K 10 7 5		♥ Q J 8 6
♦ A J 9 5		♦ 7 6 4 3 2
♣ 2		♣ J 7
♠ K J 8 7 3 2	<div style="display: inline-block; background-color: green; color: white; padding: 5px; border: 1px solid black;">           N            W      E            S         </div>	♠ Q 4
♥ 3		♥ 9 4 2
♦ K		♦ Q 10 8
♣ A Q 6 5 3		♣ K 10 9 8 4

NS 4♥; NS 2N; NS 3♦; S 2♣; NS 1♠; N 1♣; Par +620

West	North	East	South
<i>Harmon</i>	<i>nevaio</i>	<i>canalla</i>	<i>jec</i>
		Pass	Pass
1 ♠	Dbl	Pass	2 ♣
Pass	2 ♥	Pass	3 ♥
Pass	Pass	Pass	

3 ♥ by North

Trick	Lead	2nd	3rd	4th
1. E	♠ 9	4	J	<u>A</u>
2. N	♠ 5	6	Q	<u>K</u>
3. W	♠ 2	<u>10</u>	♣ J	♦ 8
4. N	<u>♥ A</u>	6	2	3
5. N	♣ 2	7	8	Q
6. W	♠ 7	♥ 5	<u>♥ J</u>	♦ 10
7. E	♦ 2	Q	K	<u>A</u>
8. N	<u>♥ K</u>	8	4	♣ 3

Down 1 — NS -100

**Board 210**  
 East Deals  
 E-W Vul

♠ K Q J 9 7 ♥ 7 ♦ 8 7 3 ♣ K 10 7 3		♠ 10 8 2 ♥ Q 10 2 ♦ A Q J 5 ♣ 8 5 4	♠ 6 4 ♥ A K 9 ♦ K 10 6 4 ♣ Q J 9 6
♠ A 5 3 ♥ J 8 6 5 4 3 ♦ 9 2 ♣ A 2			

EW 3♠; EW 4♣; NS 2♥; EW 2♦; Par -140

West	North	East	South
<i>mpasternak</i>	<i>smispi</i>	<i>vito</i>	<i>jec</i>
		1♦	Pass
1♠	Pass	1NT	2♥
2♠	3♥	Pass	Pass
4♦	Pass	4♠	Pass
Pass	Pass		

4♠ by West

<i>Trick</i>	<i>Lead</i>	<i>2nd</i>	<i>3rd</i>	<i>4th</i>
1. N	♥ 2	<u>A</u>	4	7
2. E	♠ 4	3	<u>K</u>	8
3. W	♠ Q	2	6	<u>A</u>
4. S	♣ <u>A</u>	3	4	6
5. S	♣ 2	<u>10</u>	5	9
6. W	♠ <u>J</u>	10	♦ 4	5
7. W	♣ 7	8	<u>J</u>	♥ 3
8. E	♥ <u>K</u>	5	♦ 3	10
9. E	♣ Q	♥ 6	<u>K</u>	♦ 5
10. W	♦ 7	<u>A</u>	6	2
11. N	♥ Q	-	-	-

Made 4 — NS -620

**Board 224**  
 West Deals  
 Both Vul

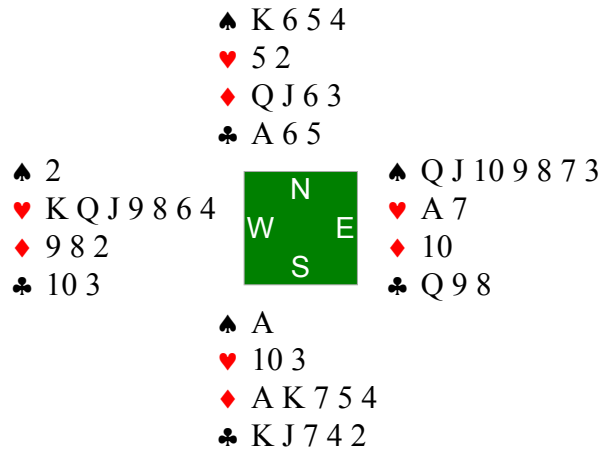

NS 5♦; NS 5♣; EW 1♠; EW 1♥; Par +600

West	North	East	South
<i>olibo</i>	<i>smispi</i>	<i>alchids</i>	<i>jec</i>
3♥	Pass	Pass	4NT
Pass	5♦	Pass	Pass
Pass			

5♦ by North

<i>Trick</i>	<i>Lead</i>	<i>2nd</i>	<i>3rd</i>	<i>4th</i>
1. E	♥ A	3	K	5
2. E	♥ 7	10	Q	2
3. W	♣ 3	5	8	J
4. S	♦ 4	2	Q	10

Made 5 — NS +600

**Board 231**  
 South Deals  
 Both Vul

♠ 9 6 3 ♥ K J 8 5 4 3 ♦ 7 5 4 ♣ A		♠ J ♥ A 10 9 2 ♦ A Q 9 8 6 2 ♣ 8 3	♠ A K 8 ♥ Q 7 ♦ K 3 ♣ K 9 7 6 5 4
		♠ Q 10 7 5 4 2 ♥ 6 ♦ J 10 ♣ Q J 10 2	

EW 3♥; EW 1N; NS 1♦; EW 1♣; Par -140

West	North	East	South
<i>pelu</i>	<i>smispi</i>	<i>mbruun</i>	<i>jec</i>
			Pass
2♥ <sup>1</sup>	Pass	4♥	4♠
Pass	Pass	Dbl	Pass
Pass	Pass		

1. 8-11

4♠× by South

Trick	Lead	2nd	3rd	4th
1. W	<u>♣ A</u>	3	4	2
2. W	<u>♦ 5</u>	<u>A</u>	3	J
3. N	<u>♠ J</u>	<u>K</u>	2	6
4. E	<u>♣ K</u>	10	<u>♦ 4</u>	8
5. E	<u>♣ 5</u>	Q	<u>♠ 3</u>	<u>♦ 2</u>
6. W	<u>♦ 7</u>	6	<u>K</u>	10
7. E	<u>♣ 6</u>	J	<u>♠ 9</u>	<u>♥ 2</u>
8. W	<u>♥ K</u>	<u>A</u>	7	6
9. N	<u>♥ 9</u>	Q	<u>♠ 4</u>	3
10. S	<u>♠ Q</u>	<u>♥ 4</u>	<u>♦ 8</u>	<u>A</u>
11. E	<u>♣ 7</u>	<u>♠ 5</u>	<u>♥ 5</u>	<u>♦ 9</u>
12. S	<u>♠ 10</u>	<u>♥ 8</u>	<u>♥ 10</u>	8
13. S	<u>♠ 7</u>	<u>♥ J</u>	<u>♦ Q</u>	<u>♣ 9</u>

Down 4 — NS -1100

**Board 233**  
 North Deals  
 E-W Vul

♠ 9 8 4	♠ 10 7 6 5 3	♠ A K Q 2
♥ 8 7 4 2	♥ K J 3	♥ Q 10 9 6 5
♦ A Q 7	♦ K 4	♦ J 10
♣ 9 8 2	♣ J 4 3	♣ K 5

♠ J
♥ A
♦ 9 8 6 5 3 2
♣ A Q 10 7 6

NS 4♦; NS 4♣; NS 2N; EW 2♥; NS 1♠; Par +130

West	North	East	South
<i>pelu</i>	<i>smispi</i>	<i>mbruun</i>	<i>jec</i>
	Pass	1♥	2NT
3♥ <sup>1</sup>	Pass	4♥	Pass
Pass	Pass		

1. not invit

4♥ by East

Trick	Lead	2nd	3rd	4th
1. S	♦ 6	7	<u>K</u>	10
2. N	♣ J	K	<u>A</u>	2
3. S	♣ Q	8	4	5
4. S	♣ 10	9	3	<u>♥ 5</u>
5. E	♦ J	2	<u>Q</u>	4
6. W	♥ 4	3	9	<u>A</u>
7. S	♠ J	4	5	<u>A</u>
8. E	♠ K	♦ 3	8	3
9. E	♠ Q	♦ 5	9	6
10. E	♠ 2	♦ 8	<u>♥ 2</u>	7
11. W	♥ 7	<u>K</u>	6	♦ 9

Down 2 — NS +200

**Board 234**  
 East Deals  
 Both Vul

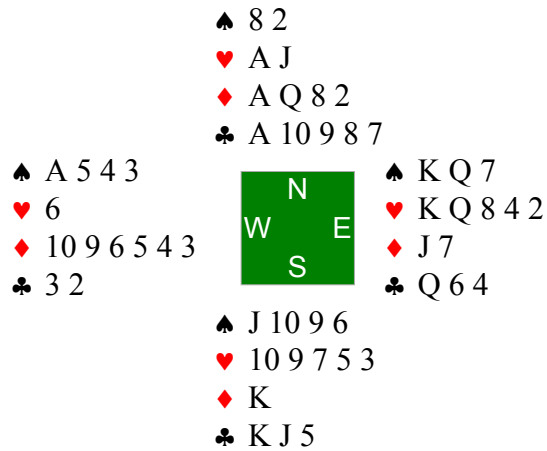

NS 3N; NS 4♣; NS 2♥; NS 1♠; NS 1♦; Par +600

West	North	East	South
<i>pelu</i>	<i>smispi</i>	<i>mbruun</i>	<i>jec</i>
		1 ♥	Pass
1 ♠	Dbl	Pass	2 ♣
Pass	Pass	2 ♠	Dbl
Pass	3 ♠	Pass	4 ♣
Pass	Pass	Pass	

4 ♣ by South

<i>Trick</i>	<i>Lead</i>	<i>2nd</i>	<i>3rd</i>	<i>4th</i>
1. W	♥ 6	<u>A</u>	4	3
2. N	♦ 2	J	<u>K</u>	3
3. S	♣ 5	2	7	<u>Q</u>
4. E	♥ <u>Q</u>	5	♦ 4	J
5. E	♠ <u>K</u>	6	3	2
6. E	♠ Q	9	<u>A</u>	8
7. W	♦ 5	8	7	<u>♣ J</u>

Down 1 — NS -100

**Board 238**  
 East Deals  
 N-S Vul

♠ A J 2 ♥ 10 8 7 6 ♦ 7 ♣ A J 10 6 3	♠ Q 5 ♥ A K Q 9 3 2 ♦ Q 10 3 2 ♣ 8		♠ 9 7 6 4 ♥ J 5 ♦ A K 8 4 ♣ 7 5 2
♠ K 10 8 3 ♥ 4 ♦ J 9 6 5 ♣ K Q 9 4			

NS 2♥; NS 3♦; NS 1N; NS 1♠; EW 1♣; Par +110

West	North	East	South
<i>gebeceli</i>	<i>nevaio</i>	<i>orhan_aga</i>	<i>jec</i>
		Pass	Pass
1 ♣	1 ♥	Dbl	Pass
2 ♣	2 ♥	3 ♣	Pass
Pass	3 ♦	Pass	Pass
4 ♣	Pass	Pass	Pass

4 ♣ by West

<i>Trick</i>	<i>Lead</i>	<i>2nd</i>	<i>3rd</i>	<i>4th</i>
1. N	<u>♥ A</u>	5	4	6
2. N	<u>♥ K</u>	J	♦ 9	7
3. N	<u>♦ Q</u>	<u>A</u>	5	7
4. E	<u>♦ K</u>	6	♠ 2	2
5. E	♦ 4	J	<u>♣ 3</u>	3
6. W	♥ 10	Q	♣ 5	<u>♣ 9</u>
7. S	♠ 3	<u>A</u>	5	4
8. W	♥ 8	9	♣ 7	<u>♣ Q</u>
9. S	<u>♠ K</u>	J	Q	6
10. S	♠ 10	<u>♣ 10</u>	♥ 2	7
11. W	<u>♣ A</u>	8	2	4
12. W	♣ J	♦ 10	♦ 8	<u>K</u>
13. S	♠ 8	<u>♣ 6</u>	♥ 3	9

Down 3 — NS +150

**Board 242**  
 East Deals  
 E-W Vul

♠ A K J 9 6 ♥ 2 ♦ 10 4 2 ♣ J 9 8 6		♠ 10 3 ♥ Q J 9 7 3 ♦ 9 3 ♣ A K Q 4	♠ 7 5 ♥ K 4 ♦ A J 8 7 6 5 ♣ 10 7 5
		♠ Q 8 4 2 ♥ A 10 8 6 5 ♦ K Q ♣ 3 2	

NS 3N; NS 3♥; EW 2♦; NS 1♣; Par +400

West	North	East	South
<i>gebeceli</i>	<i>nevaio</i>	<i>orhan_aga</i>	<i>jec</i>
		Pass	Pass
1 ♠	Dbl	Pass	4 ♥
Pass	Pass	Pass	

4 ♥ by South

<i>Trick</i>	<i>Lead</i>	<i>2nd</i>	<i>3rd</i>	<i>4th</i>
1. W	<u>♠ K</u>	3	7	2
2. W	<u>♠ A</u>	10	5	4
3. W	♦ 4	3	<u>A</u>	K
4. E	♦ 8	<u>Q</u>	2	9
5. S	<u>♥ A</u>	2	3	4
6. S	♥ 5	♦ 10	7	<u>K</u>
7. E	♣ 5	-	-	-

Down 1 — NS -50



**Board 244**  
 West Deals  
 None Vul

♠ Q J 9 4 ♥ 9 5 ♦ Q 9 7 4 ♣ K 10 9	<div style="background-color: green; color: white; padding: 5px; width: 40px; height: 40px; margin: 0 auto; display: flex; flex-direction: column; align-items: center; justify-content: center;"> <span>N</span> <span>W</span> <span>E</span> <span>S</span> </div>	♠ K 3 2 ♥ 10 4 3 ♦ J 3 ♣ Q 8 7 5 4	♠ 8 7 5 ♥ A K J 6 ♦ A 10 5 ♣ J 3 2
♠ A 10 6 ♥ Q 8 7 2 ♦ K 8 6 2 ♣ A 6			

NS 1N; EW 1♠; NS 1♥; EW 1♦; NS 1♣; Par +90

West	North	East	South
<i>gebeceli</i>	<i>nevaio</i>	<i>orhan_aga</i>	<i>jec</i>
Pass	Pass	1 ♣	Dbl
1 ♠	Pass	Pass	Pass

1 ♠ by West

<i>Trick</i>	<i>Lead</i>	<i>2nd</i>	<i>3rd</i>	<i>4th</i>
1. N	♠ 2	5	<u>A</u>	4
2. S	♣ A	10	4	2
3. S	♣ 6	<u>K</u>	5	3
4. W	♥ 9	3	<u>A</u>	7
5. E	♠ 7	6	Q	<u>K</u>
6. N	♣ Q	J	♦ 2	9
7. N	♥ 10	<u>K</u>	2	5
8. E	♦ A	6	4	3
9. E	♦ 10	<u>K</u>	7	J
10. S	♥ Q	♠ 9	4	6
11. W	♦ 9	♠ 3	5	8
12. N	♣ 7	♠ 8	♠ 10	-

Made 1 — NS -80

**Board 246**  
 East Deals  
 Both Vul

♠ A 9	♠ Q J 5 4 2	♠ 7 6
♥ 10 9 3	♥ K Q 4 2	♥ A J 5
♦ A J 7 6 4 2	♦ K 8	♦ Q 9
♣ A 2	♣ K 10	♣ Q J 8 5 4 3

♠ K 10 8 3
♥ 8 7 6
♦ 10 5 3
♣ 9 7 6

EW 2N; NS 2♠; EW 3♦; EW 3♣; Par -120

West	North	East	South
<i>gebeceli</i>	<i>nevaio</i>	<i>orhan_aga</i>	<i>jec</i>
		Pass	Pass
1 ♦	1 ♠	2 ♣	3 ♠
Pass	Pass	Pass	

3 ♠ by North

<i>Trick</i>	<i>Lead</i>	<i>2nd</i>	<i>3rd</i>	<i>4th</i>
1. E	♦ Q	3	<u>A</u>	8
2. W	♦ 6	<u>K</u>	9	5
3. N	♠ 5	6	K	<u>A</u>
4. W	♦ J	<u>♠ J</u>	♣ 4	10
5. N	♠ 2	7	<u>10</u>	9
6. S	♥ 6	3	K	<u>A</u>
7. E	♣ 3	6	<u>A</u>	10
8. W	♣ 2	<u>K</u>	5	7

Down 1 — NS -100

**Board 250**  
 East Deals  
 None Vul

♠ 8 6 4 3 ♥ Q 7 3 2 ♦ A 10 8 ♣ J 4		♠ K 9 ♥ K J ♦ Q 9 6 4 ♣ Q 9 7 6 3	♠ A J ♥ A 9 5 4 ♦ 3 2 ♣ K 10 8 5 2
		♠ Q 10 7 5 2 ♥ 10 8 6 ♦ K J 7 5 ♣ A	

NS 2♠; EW 2♥; NS 3♦; EW 1♣; Par +100; EW 3♥×-1

West	North	East	South
<i>gebeceli</i>	<i>nevaio</i>	<i>orhan_aga</i>	<i>jec</i>
		1 ♣	Pass
1 ♥	Pass	2 ♥	2 ♠
Pass	Pass	Pass	

2 ♠ by South

<i>Trick</i>	<i>Lead</i>	<i>2nd</i>	<i>3rd</i>	<i>4th</i>
1. W	♥ 3	J	<u>A</u>	6
2. E	♦ 3	5	<u>A</u>	4
3. W	♣ J	Q	K	<u>A</u>
4. S	♥ 8	7	<u>K</u>	4
5. N	♦ 6	2	<u>K</u>	8
6. S	♥ 10	Q	<u>♠ 9</u>	5
7. N	♠ K	<u>A</u>	2	4
8. E	♣ 10	<u>♠ 5</u>	4	3
9. S	<u>♠ Q</u>	3	♣ 6	J
10. S	<u>♠ 10</u>	6	♣ 7	♥ 9
11. S	♦ J	10	<u>Q</u>	♣ 2
12. N	♦ 9	♣ 5	7	<u>♠ 8</u>
13. W	♥ 2	♣ 9	♣ 8	<u>♠ 7</u>

Made 3 — NS +140

**Board 253**  
 North Deals  
 None Vul

♠ 7 5 3 2 ♥ A J 8 2 ♦ K J 9 ♣ J 5		♠ K Q 9 4 ♥ — ♦ 10 7 4 3 ♣ K Q 6 4 2	♠ A 10 ♥ Q 9 3 ♦ A Q 8 6 ♣ A 9 8 3
♠ J 8 6 ♥ K 10 7 6 5 4 ♦ 5 2 ♣ 10 7			

EW 3N; EW 3♥; EW 2♠; EW 3♦; EW 2♣; Par -400

West	North	East	South
<i>gebeceli</i>	<i>nevaio</i>	<i>orhan_aga</i>	<i>jec</i>
	Pass	1 NT	Pass
2 ♣	Dbl	Pass	Pass
Rdbl <sup>1</sup>	Pass	2 ♦	Pass
Pass	Pass		

1. re styman

2 ♦ by East

Trick	Lead	2nd	3rd	4th
1. S	♦ 2	9	10	<u>Q</u>
2. E	♥ 3	4	J	<u>♦ 3</u>
3. N	♦ 4	6	5	<u>J</u>
4. W	<u>♦ K</u>	7	8	♥ 5
5. W	♣ 5	2	8	<u>10</u>
6. S	♣ 7	J	Q	<u>A</u>
7. E	<u>♦ A</u>	♥ 6	♥ 2	♠ 4
8. E	<u>♠ A</u>	6	2	9
9. E	♠ 10	8	3	<u>Q</u>
10. N	<u>♣ K</u>	3	♥ 7	♠ 5
11. N	<u>♠ K</u>	♥ 9	J	7
12. N	♣ 4	<u>9</u>	♥ 10	♥ 8
13. E	♥ Q	K	<u>A</u>	♣ 6

Made 2 — NS -90

**Board 258**  
 East Deals  
 E-W Vul

♠ 7 5 3 2	♠ K J 8	♠ 4
♥ Q 5 4 2	♥ K 10 9	♥ A J 8 7 6 3
♦ K Q 9 6 3	♦ A 5 4	♦ 10 8 7
♣ —	♣ 9 5 4 2	♣ K 10 3

♠ A Q 10 9 6
♥ —
♦ J 2
♣ A Q J 8 7 6

NS 7♣; N 6N; S 5N; NS 5♠; EW 4♥; E 2♦; W 1♦; Par +800:  
 EW 7♥×-3

West	North	East	South
<i>gebeceli</i>	<i>nevaio</i>	<i>orhan_aga</i>	<i>jec</i>
		2♦ <sup>1</sup>	4♣
4♥ <sup>2</sup>	5♣	Pass	Pass

Pass

1. multi

2. P/C

5♣ by South

<i>Trick</i>	<i>Lead</i>	<i>2nd</i>	<i>3rd</i>	<i>4th</i>
1. W	♦ K	<u>A</u>	7	2
2. N	♣ 2	3	<u>A</u>	♦ 3
3. S	♣ J	♠ 2	4	<u>K</u>
4. E	♦ 8	J	<u>Q</u>	4
5. W	♦ 9	5	10	<u>♣ 6</u>
6. S	♠ 6	5	<u>J</u>	4
7. N	♣ 9	10	-	-

Made 5 — NS +400

**Board 263**  
 South Deals  
 None Vul

♠ K 8 7 2 ♥ A 5 ♦ — ♣ A K Q 10 8 6 5		♠ A 5 ♥ Q J 10 9 4 ♦ K J 10 4 ♣ J 4	♠ Q J 10 6 4 ♥ K 6 ♦ A 9 8 ♣ 9 7 2
		♠ 9 3 ♥ 8 7 3 2 ♦ Q 7 6 5 3 2 ♣ 3	

EW 6♣; EW 5♠; EW 4N; NS 2♦; NS 1♥; Par -800; NS 6♦×-4

West	North	East	South
<i>gebeceli</i>	<i>nevaio</i>	<i>orhan_aga</i>	<i>jec</i>
			Pass
1 ♣	1 ♥	1 ♠	3 ♥
4 ♥	Pass	4 ♠	Pass
4 NT	Pass	5 ♣ <sup>1</sup>	Pass
5 ♦	Dbl	6 ♥	Pass
7 ♠	Dbl	Pass	Pass

Pass

1. 1-4

7 ♠× by East

Lead: ♦ 7

Down 1 — NS +100

**Board 265**  
 North Deals  
 None Vul

♠ A J 9		♠ K 7 5
♥ K 8 5		♥ J 7 6
♦ K 10 7 6 3		♦ A J 5 2
♣ 9 3		♣ A 7 5
♠ Q 10 8 6 4 3	<div style="display: inline-block; background-color: green; color: white; padding: 5px; border: 1px solid black;">           N            W     E                 S         </div>	
♥ Q 9 3 2		
♦ —		
♣ J 4 2		
♠ 2		
♥ A 10 4		
♦ Q 9 8 4		
♣ K Q 10 8 6		

NS 4♦; NS 2N; EW 2♠; NS 3♣; NS 1♥; Par +130

West	North	East	South
<i>weedo</i>	<i>BridgeGoth</i>	<i>leroumain</i>	<i>jec</i>
	Pass	1♦	Pass
1♠	Pass	1NT	2♣
2♠	Pass	Pass	Pass

2♠ by West

<i>Trick</i>	<i>Lead</i>	<i>2nd</i>	<i>3rd</i>	<i>4th</i>
1. N	♣ 9	<u>A</u>	6	2
2. E	♠ 5	2	Q	<u>A</u>
3. N	♣ 3	5	<u>Q</u>	4
4. S	<u>♣ K</u>	J	♦ 3	7
5. S	♥ 4	9	<u>K</u>	6
6. N	♥ 8	7	<u>A</u>	2
7. S	♣ 10	<u>♠ 6</u>	♥ 5	♥ J
8. W	♠ 3	9	<u>K</u>	♣ 8
9. E	♦ A	4	♥ 3	6

Down 1 — NS +50

**Board 266**  
 East Deals  
 N-S Vul

♠ A K 9 8 5 ♥ A 7 4 3 ♦ 2 ♣ 10 7 3		♠ 4 2 ♥ Q 10 9 ♦ A K Q 5 4 3 ♣ J 8	♠ 10 7 6 ♥ J 6 ♦ J 10 7 ♣ A K Q 9 5
		♠ Q J 3 ♥ K 8 5 2 ♦ 9 8 6 ♣ 6 4 2	

EW 5♠; EW 5♣; EW 1N; NS 2♦; EW 1♥; Par -450

West	North	East	South
<i>weedo</i>	<i>BridgeGoth</i>	<i>leroumain</i>	<i>jec</i>
		1 ♣	Pass
1 ♠	2 ♦	Pass	3 ♦
Dbl	Pass	3 ♠	Pass
Pass	Pass		

3 ♠ by West

<i>Trick</i>	<i>Lead</i>	<i>2nd</i>	<i>3rd</i>	<i>4th</i>
1. N	♦ <u>A</u>	7	6	2
2. N	♦ K	10	9	♠ <u>5</u>
3. W	♠ <u>A</u>	4	6	3
4. W	♠ <u>K</u>	2	7	J
5. W	♣ 3	8	<u>A</u>	2
6. E	♣ <u>K</u>	4	7	J
7. E	♣ <u>Q</u>	6	10	♦ 3
8. E	♣ 9	♠ <u>Q</u>	♥ 3	♦ 4
9. S	♦ 8	-	-	-

Made 4 — NS -170



**Board 271**  
 South Deals  
 Both Vul

♠ A 3 ♥ 7 5 2 ♦ A K 9 8 5 4 ♣ 9 8	♠ J 8 6 4 ♥ A K Q J 10 6 ♦ Q 7 ♣ 3	<div style="background-color: green; color: white; padding: 5px; width: 40px; height: 40px; margin: 0 auto; display: flex; flex-direction: column; align-items: center; justify-content: center;"> <span>N</span> <span>W</span> <span>S</span> <span>E</span> </div>	♠ K Q 10 9 7 5 ♥ 3 ♦ 3 2 ♣ A K 10 5
♠ 2 ♥ 9 8 4 ♦ J 10 6 ♣ Q J 7 6 4 2			

EW 5♠; EW 4♦; EW 1N; NS 1♥; EW 1♣; Par -650

West	North	East	South
<i>weedo</i>	<i>BridgeGoth</i>	<i>leroumain</i>	<i>jec</i>
			Pass
1 ♦	1 ♥	1 ♠	2 ♥
Pass	Pass	Dbl	Pass
3 ♦	3 ♥	Dbl <sup>1</sup>	Pass
3 ♠	Pass	4 ♠	Pass
Pass	Pass		

1. to

4 ♠ by East

Trick	Lead	2nd	3rd	4th
1. S	♥ 9	2	<u>10</u>	3
2. N	♣ 3	<u>A</u>	7	8
3. E	♣ K	6	9	<u>♠ 4</u>
4. N	♥ A	<u>♠ 5</u>	8	5
5. E	♣ 5	J	<u>♠ A</u>	♥ J
6. W	♠ 3	6	<u>K</u>	2
7. E	<u>♠ Q</u>	♥ 4	♦ 4	8
8. E	♠ 10	♣ 2	♦ 5	<u>J</u>
9. N	♥ K	<u>♠ 7</u>	♣ 4	7
10. E	<u>♠ 9</u>	♦ 6	♦ 8	♥ 6
11. E	♦ 2	10	<u>A</u>	7
12. W	<u>♦ K</u>	Q	3	J
13. W	<u>♦ 9</u>	♥ Q	♣ 10	♣ Q

Made 4 — NS -620

**Board 272**  
 West Deals  
 None Vul

♠ 9 7 ♥ K 8 6 5 4 2 ♦ A ♣ A J 9 2		♠ A K 8 5 ♥ J 10 ♦ Q 9 7 5 4 ♣ K 10	♠ Q J 10 6 ♥ A 9 7 3 ♦ 10 8 3 ♣ 6 5
♠ 4 3 2 ♥ Q ♦ K J 6 2 ♣ Q 8 7 4 3			

EW 4♥; EW 2N; NS 3♦; NS 1♠; NS 1♣; Par -300; NS 5♦×-2

West	North	East	South
<i>weedo</i>	<i>BridgeGoth</i>	<i>leroumain</i>	<i>jec</i>
1 ♥	Dbl	2 ♥	Dbl
4 ♥	5 ♦	Dbl	Pass
Pass	Pass		

5♦× by North

<i>Trick</i>	<i>Lead</i>	<i>2nd</i>	<i>3rd</i>	<i>4th</i>
1. E	♥ <u>A</u>	Q	2	J
2. E	♣ 6	3	<u>A</u>	10
3. W	♣ 2	<u>K</u>	5	4
4. N	♥ 10	3	♦ <u>2</u>	4
5. S	♦ 6	<u>A</u>	4	3
6. W	♣ 9	♦ <u>Q</u>	♥ 7	7
7. N	♦ 5	8	-	-

Down 1 — NS -100

**Board 280**  
 West Deals  
 E-W Vul

♠ Q J ♥ Q J 9 8 2 ♦ K 10 9 ♣ J 8 6		♠ 9 8 2 ♥ — ♦ 8 4 3 2 ♣ 9 7 5 4 3 2	♠ K 10 7 6 4 ♥ K 7 6 4 ♦ 7 5 ♣ A Q
		♠ A 5 3 ♥ A 10 5 3 ♦ A Q J 6 ♣ K 10	

E 4♥; W 3♥; NS 3♣; EW 1N; NS 2♦; EW 1♠; Par -300: NS 5♣×-2

West	North	East	South
<i>weedo</i>	<i>BridgeGoth</i>	<i>leroumain</i>	<i>jec</i>
Pass	Pass	1 ♠	Dbl
1 NT	Pass	Pass	Pass

1 NT by West

<i>Trick</i>	<i>Lead</i>	<i>2nd</i>	<i>3rd</i>	<i>4th</i>
1. N	♦ 2	5	J	<u>K</u>
2. W	♥ J	♣ 2	4	3
3. W	♠ J	2	4	3
4. W	♠ Q	9	6	5
5. W	♥ 2	♣ 3	K	<u>A</u>
6. S	♦ A	9	3	7
7. S	♦ Q	10	4	♥ 6
8. S	♦ 6	♣ 6	<u>8</u>	♠ 7
9. N	♣ 4	<u>A</u>	10	8
10. E	♥ 7	5	<u>8</u>	♠ 8
11. W	♥ Q	♣ 5	♣ Q	10
12. W	♥ 9	♣ 7	♠ 10	♠ A
13. W	♣ J	9	♠ K	<u>K</u>

Made 2 — NS -120

**Board 282**  
 East Deals  
 N-S Vul

♠ A K 7 6 4			
♥ 10 6 5			
♦ K 10 7			
♣ A K			
♠ Q 10 9 5 2	♠ 3		
♥ Q 9 4 2	♥ A J 7 3		
♦ —	♦ A 8 5 4 2		
♣ 9 7 5 3	♣ Q J 10		
	<div style="display: inline-block; background-color: green; color: white; padding: 5px; border: 1px solid black;">           N            W     E                 S         </div>		
♠ J 8			
♥ K 8			
♦ Q J 9 6 3			
♣ 8 6 4 2			

NS 2N; S 2♠; NS 3♦; N 1♠; EW 1♥; NS 1♣; Par +120

West	North	East	South
<i>weedo</i>	<i>BridgeGoth</i>	<i>leroumain</i>	<i>jec</i>

1 ♠	1 NT	1 ♦	Pass
Pass		Pass	Pass

Pass

1 NT by North

<i>Trick</i>	<i>Lead</i>	<i>2nd</i>	<i>3rd</i>	<i>4th</i>
1. E	♦ 4	3	♣ 3	<u>7</u>
2. N	♦ <u>K</u>	2	6	♣ 5
3. N	♦ 10	<u>A</u>	Q	♣ 7
4. E	♥ 3	<u>K</u>	4	5

Made 3 — NS +150

**Board 285**  
 North Deals  
 N-S Vul

♠ 6 4 ♥ 10 7 6 4 2 ♦ K 10 8 4 2 ♣ 5	♠ 10 9 8 5 ♥ K Q 8 5 ♦ Q 9 ♣ J 10 8		♠ Q 7 ♥ A 9 3 ♦ 6 5 ♣ A K Q 9 3 2
♠ A K J 3 2 ♥ J ♦ A J 7 3 ♣ 7 6 4			

NS 2♠; EW 1N; EW 2♣; EW 1♥; EW 1♦; Par +100; EW 2N×-1;  
 EW 3♣×-1

West	North	East	South
<i>weedo</i>	<i>BridgeGoth</i>	<i>leroumain</i>	<i>jec</i>
	Pass	1 NT	2♥ <sup>1</sup>
Pass	2♠	3♣	Pass
3♦	Pass	3 NT	Pass
4♦	Dbl	Pass	Pass
Pass			

1. s

4♦× by West

Trick	Lead	2nd	3rd	4th
1. N	♠ 10	Q	<u>K</u>	4
2. S	♠ J	6	9	7
3. S	♥ J	2	8	<u>A</u>
4. E	♥ 9	♣ 4	4	<u>Q</u>
5. N	♥ K	3	♣ 6	6
6. N	♥ 5	♣ 2	<u>♦ 7</u>	7
7. S	♠ A	<u>♦ 2</u>	5	♣ 3
8. W	♣ 5	8	<u>A</u>	7
9. E	♦ 5	3	<u>K</u>	9
10. W	♦ 4	Q	6	<u>A</u>
11. S	♠ 3	<u>♦ 8</u>	8	♣ 9
12. W	♥ 10	♣ J	♣ Q	<u>♦ J</u>
13. S	♠ 2	<u>♦ 10</u>	♣ 10	♣ K

Down 4 — NS +800

**Board 286**  
 East Deals  
 E-W Vul

♠ 7 6 4 ♥ K Q 3 ♦ K 10 8 7 ♣ A Q 4	♠ Q J 10 ♥ J 4 2 ♦ Q 6 5 2 ♣ K 3 2	<div style="text-align: center; border: 1px solid black; width: 40px; height: 40px; margin: 0 auto; background-color: #006400; color: white; display: flex; flex-direction: column; align-items: center; justify-content: center;"> <span>N</span> <span>W</span> <span>S</span> <span>E</span> </div>	♠ A K 5 3 2 ♥ 7 ♦ A J 4 3 ♣ 10 8 6
---	---	--	---

♠ 9 8  
 ♥ A 10 9 8 6 5  
 ♦ 9  
 ♣ J 9 7 5

W 5♠; EW 4N; E 4♠; EW 4♦; EW 2♣; EW 1♥; Par -650

West	North	East	South
<i>weedo</i>	<i>BridgeGoth</i>	<i>leroumain</i>	<i>jec</i>
		1 ♠	Pass
2 ♣	Pass	2 ♦	Pass
3 ♦	Pass	3 ♥	Dbl
3 NT	Pass	Pass	Pass

3 NT by West

<i>Trick</i>	<i>Lead</i>	<i>2nd</i>	<i>3rd</i>	<i>4th</i>
1. N	♥ 2	7	<u>A</u>	3
2. S	♥ 8	<u>K</u>	J	♣ 6
3. W	♠ 4	<u>Q</u>	2	8
4. N	♥ 4	♣ 8	9	<u>Q</u>
5. W	♠ 7	<u>J</u>	3	9
6. N	♠ 10	<u>A</u>	♥ 6	6
7. E	♦ 3	9	10	<u>Q</u>

Made 3 — NS -600

**Board 298**  
 East Deals  
 E-W Vul

♠ 9 6 3	♠ K Q 10	♠ J 8 4 2
♥ A 9	♥ K J 8 6 5 4	♥ Q 10
♦ A 10 9 5 3 2	♦ Q	♦ K 7
♣ 10 9	♣ K 4 2	♣ A 8 6 5 3

N
W      E
S

♠ A 7 5
♥ 7 3 2
♦ J 8 6 4
♣ Q J 7

NS 3♥; EW 1♠; EW 1♦; Par +140

West	North	East	South
<i>StuC</i>	<i>smispi</i>	<i>forissimo</i>	<i>jec</i>
		Pass	Pass
2♦ <sup>1</sup>	2♥	Pass	3♥
Pass	Pass	Pass	

1. weak 2

3♥ by North

<i>Trick</i>	<i>Lead</i>	<i>2nd</i>	<i>3rd</i>	<i>4th</i>
1. E	<u>♦ K</u>	4	10	Q
2. E	♦ 7	8	9	<u>♥ 4</u>
3. N	♠ 10	2	<u>A</u>	3
4. S	♥ 2	9	J	<u>Q</u>
5. E	♠ 4	5	9	<u>Q</u>
6. N	♣ 4	3	<u>Q</u>	10
7. S	♥ 3	<u>A</u>	5	10

Made 3 — NS +140

**Board 310**  
 East Deals  
 N-S Vul

♠ 10 8 4 ♥ A Q 9 2 ♦ K J 9 ♣ A K 6		♠ 9 5 ♥ K 5 3 ♦ A Q 5 3 2 ♣ 9 4 3	♠ J 6 2 ♥ J 8 7 ♦ 10 7 6 4 ♣ Q 7 5
♠ A K Q 7 3 ♥ 10 6 4 ♦ 8 ♣ J 10 8 2			

NS 2N; NS 2♠; NS 2♣; NS 1♥; NS 1♦; Par +120

West	North	East	South
<i>StuC</i>	<i>smispi</i>	<i>forissimo</i>	<i>jec</i>
		Pass	Pass
1 NT	Pass	Pass	2♥ <sup>1</sup>
Pass	2♠	Pass	Pass
Pass			

1. s

2♠ by North

<i>Trick</i>	<i>Lead</i>	<i>2nd</i>	<i>3rd</i>	<i>4th</i>
1. E	♠ 2	<u>A</u>	4	5
2. S	♣ 2	<u>K</u>	3	5
3. W	♠ 8	9	J	<u>Q</u>
4. S	♦ 8	9	<u>Q</u>	4
5. N	♣ 4	<u>Q</u>	8	6
6. E	♠ 6	<u>K</u>	10	♦ 2
7. S	♣ 10	<u>A</u>	9	7
8. W	♦ K	<u>A</u>	6	♥ 4
9. N	♦ 3	7	<u>♠ 3</u>	J
10. S	<u>♣ J</u>	♥ 2	♦ 5	♦ 10
11. S	♥ 6	<u>A</u>	3	7

Made 3 — NS +140



**Board 316**  
 West Deals  
 Both Vul

♠ Q 10 2 ♥ A 7 6 4 ♦ 6 ♣ Q 9 5 4 3		♠ K J 9 3 ♥ Q 8 5 ♦ 8 ♣ K J 10 8 6	♠ 6 4 ♥ J 3 ♦ Q J 9 7 5 3 2 ♣ A 7
		♠ A 8 7 5 ♥ K 10 9 2 ♦ A K 10 4 ♣ 2	

NS 5♠; NS 5♥; NS 4N; NS 3♣; NS 1♦; Par +650

West	North	East	South
<i>faramarz</i>	<i>smispi</i>	<i>mselfigman</i>	<i>jec</i>
Pass	Pass	2♦ <sup>1</sup>	Dbl
Pass	4♠	Pass	Pass
Pass			

1. weak 2

4♠ by North

<i>Trick</i>	<i>Lead</i>	<i>2nd</i>	<i>3rd</i>	<i>4th</i>
1. E	♦ Q	<u>K</u>	6	8
2. S	♣ 2	3	J	<u>A</u>
3. E	♥ J	<u>K</u>	7	5
4. S	♦ A	♠ 10	<u>♠ J</u>	5
5. N	<u>♠ K</u>	4	5	2
6. N	♠ 3	6	<u>A</u>	Q
7. S	♥ 2	4	-	-

Made 5 — NS +650

**Board 318**  
 East Deals  
 E-W Vul

♠ 7 ♥ 9 7 5 4 ♦ J 10 6 4 2 ♣ A 9 2	♠ K 10 9 8 2 ♥ Q 8 6 3 2 ♦ A ♣ J 6		♠ A J 6 4 ♥ A ♦ K 7 ♣ K 10 8 7 4 3
♠ Q 5 3 ♥ K J 10 ♦ Q 9 8 5 3 ♣ Q 5			

EW 3N; EW 5♣; EW 2♦; NS 1♠; NS 1♥; Par -600

West	North	East	South
<i>faramarz</i>	<i>smispi</i>	<i>mselfigman</i>	<i>jec</i>
		1 ♣	Pass
1 ♥	1 ♠	2 ♣	2 ♠
Pass	Pass	Pass	

2 ♠ by North

<i>Trick</i>	<i>Lead</i>	<i>2nd</i>	<i>3rd</i>	<i>4th</i>
1. E	♣ 8	5	<u>A</u>	6
2. W	♣ 9	J	<u>K</u>	Q
3. E	♥ <u>A</u>	10	7	3
4. E	♣ 10	♦ 3	2	<u>♠ 2</u>
5. N	♥ 6	♣ 3	<u>K</u>	4
6. S	♥ J	5	2	<u>♠ 4</u>
7. E	♣ 4	♦ 5	♠ 7	<u>♠ 8</u>
8. N	♠ 9	J	<u>Q</u>	♦ 2
9. S	♠ 3	♦ 4	10	<u>A</u>
10. E	♠ 6	-	-	-

Made 2 — NS +110

**Board 330**  
 East Deals  
 E-W Vul

♠ K		♠ —
♥ A Q J 8 2		♥ 3
♦ A 10 8 2		♦ J 9 7 3
♣ 8 7 5		♣ A K Q J 10 9 3 2
♠ Q J 9 8 7 5	<div style="display: inline-block; background-color: green; color: white; padding: 5px; border: 1px solid black;">           N            W     E            S         </div>	♠ —
♥ 10 5 4		♥ 3
♦ Q 5 4		♦ J 9 7 3
♣ 4		♣ A K Q J 10 9 3 2
♠ A 10 6 4 3 2		
♥ K 9 7 6		
♦ K 6		
♣ 6		

NS 4♥; NS 3♠; EW 3♣; NS 1♦; Par +420

West	North	East	South
<i>SaccoMan</i>	<i>ronpa</i>	<i>hjedda</i>	<i>jec</i>
Pass	2♥	1♣	1♠
Pass	Pass	3♣	4♥
		Pass	

4♥ by North

<i>Trick</i>	<i>Lead</i>	<i>2nd</i>	<i>3rd</i>	<i>4th</i>
1. E	<u>♣K</u>	6	4	5
2. E	♦7	6	Q	<u>A</u>
3. N	<u>♥Q</u>	3	6	5
4. N	<u>♥J</u>	♣3	7	4
5. N	<u>♠K</u>	♣2	2	7
6. N	♦2	3	<u>K</u>	5
7. S	<u>♠A</u>	5	♣7	♣9
8. S	♠3	8	<u>♥2</u>	♣10
9. N	♦10	J	<u>♥9</u>	4
10. S	♠4	9	<u>♥8</u>	♣J
11. N	♣8	Q	<u>♥K</u>	♠J
12. S	♠6	Q	<u>♥A</u>	♣A
13. N	♦8	9	♠10	<u>♥10</u>

Made 5 — NS +450

**Board 332**  
 West Deals  
 None Vul

♠ J 10 7 2	♠ K 5	♠ Q 8
♥ A 3	♥ J 10 9 5 4 2	♥ 6
♦ A J 10 9 5 4	♦ K Q 2	♦ 8 7 3
♣ K	♣ A 5	♣ Q J 9 8 7 3 2

♠ A 9 6 4 3	<table border="1" style="background-color: #006400; color: white; width: 40px; height: 40px; margin: auto;"> <tr><td style="text-align: center;">N</td></tr> <tr><td style="text-align: center;">W   E</td></tr> <tr><td style="text-align: center;">S</td></tr> </table>	N	W   E	S	♠ Q 8
N					
W   E					
S					
♥ K Q 8 7		♥ 6			
♦ 6		♦ 8 7 3			
♣ 10 6 4		♣ Q J 9 8 7 3 2			

NS 5♥; NS 3N; NS 2♠; EW 2♦; EW 2♣; Par +450

West	North	East	South
<i>SaccoMan</i>	<i>ronpa</i>	<i>hjedda</i>	<i>jec</i>
1♦	1♥	Pass	4♥
Pass	Pass	Pass	

4♥ by North

Trick	Lead	2nd	3rd	4th
1. E	♦ 3	6	<u>A</u>	2
2. W	♣ K	<u>A</u>	3	4
3. N	<u>♦ Q</u>	7	♣ 6	5
4. N	<u>♦ K</u>	8	♣ 10	9

Made 5 — NS +450

**Board 334**  
 East Deals  
 Both Vul

♠ K 3 2 ♥ A J 4 3 2 ♦ Q J 7 5 ♣ Q		♠ A Q 7 5 ♥ K 9 ♦ A 6 ♣ K 10 6 5 2	♠ J 9 8 ♥ 8 7 ♦ K 10 3 ♣ J 9 7 4 3
		♠ 10 6 4 ♥ Q 10 6 5 ♦ 9 8 4 2 ♣ A 8	

NS 2N; NS 2♠; NS 2♣; NS 1♥; NS 1♦; Par +120

West	North	East	South
<i>SaccoMan</i>	<i>ronpa</i>	<i>hjedda</i>	<i>jec</i>
		Pass	Pass
1 ♥	Dbl	Pass	1 NT
Pass	3 NT	Pass	Pass

Pass

3 NT by South

<i>Trick</i>	<i>Lead</i>	<i>2nd</i>	<i>3rd</i>	<i>4th</i>
1. W	♥ 2	9	8	<u>10</u>
2. S	♠ 4	3	<u>Q</u>	8
3. N	♣ 2	3	<u>A</u>	Q
4. S	♣ 8	♥ 3	<u>K</u>	4
5. N	♠ 5	J	6	<u>K</u>
6. W	♦ 5	6	<u>K</u>	2
7. E	♦ 10	4	7	<u>A</u>
8. N	♠ A	9	10	2
9. N	♠ 7	♣ 7	♥ 5	♥ 4
10. N	♥ K	7	6	<u>A</u>
11. W	♦ Q	♣ 5	3	8
12. W	♦ J	♣ 6	♣ 9	9
13. W	♥ J	♣ 10	♣ J	Q

Down 1 — NS -100

**Board 336**  
 West Deals  
 N-S Vul

♠ 10 6 5 ♥ Q J 7 6 5 3 ♦ 7 4 ♣ 6 5		♠ K J 8 7 4 2 ♥ A 4 ♦ K 3 2 ♣ J 7	♠ A 9 ♥ K 9 8 ♦ Q J 10 ♣ K 9 8 4 2
♠ Q 3 ♥ 10 2 ♦ A 9 8 6 5 ♣ A Q 10 3			

NS 5♠; NS 4♦; NS 1N; NS 2♣; EW 1♥; Par +650

West	North	East	South
<i>SaccoMan</i>	<i>ronpa</i>	<i>hjedda</i>	<i>jec</i>
2♥	2♠	3♥	Dbl
Pass	3♠	Pass	4♠
Pass	Pass	Pass	

4♠ by North

<i>Trick</i>	<i>Lead</i>	<i>2nd</i>	<i>3rd</i>	<i>4th</i>
1. E	♥ 8	2	J	<u>A</u>
2. N	♠ 2	9	<u>Q</u>	5
3. S	♠ 3	6	J	<u>A</u>
4. E	♥ <u>K</u>	10	6	4
5. E	♥ 9	♦ 5	Q	<u>♠ 4</u>
6. N	♠ <u>K</u>	♣ 2	♦ 6	10
7. N	♣ <u>J</u>	4	3	5
8. N	♣ 7	8	<u>10</u>	6

Made 5 — NS +650

**Board 338**  
 East Deals  
 None Vul

	♠ 5 3 2		
	♥ A Q J 2		
	♦ A Q 6		
	♣ A 9 3		
♠ A 10 ♥ 10 9 6 4 ♦ J 9 7 4 ♣ K J 7	<div style="background-color: #008000; color: white; padding: 10px; display: inline-block;">           N            W     E            S         </div>	♠ K J 7 6 4 ♥ K 8 5 3 ♦ 10 3 ♣ 10 6	
	♠ Q 9 8		
	♥ 7		
	♦ K 8 5 2		
	♣ Q 8 5 4 2		

NS 3♦; NS 3♣; S 1N; EW 1♥; Par +110

West	North	East	South
<i>SaccoMan</i>	<i>ronpa</i>	<i>hjedda</i>	<i>jec</i>
		2♦ <sup>1</sup>	Pass
2♥	2NT	Pass	3♥
Pass	3♠	Pass	3NT
Pass	Pass	Pass	

1. Both Major 5-10 hp

3 NT by North

Trick	Lead	2nd	3rd	4th
1. E	♥ 5	7	9	<u>Q</u>
2. N	♣ 3	6	8	<u>J</u>
3. W	♥ 4	<u>A</u>	3	♠ 8
4. N	♦ <u>Q</u>	3	2	4
5. N	♦ <u>A</u>	10	5	7
6. N	♦ 6	♠ 6	<u>K</u>	9
7. S	♣ 2	7	<u>A</u>	10
8. N	♠ 2	<u>K</u>	9	10
9. E	♠ 4	Q	<u>A</u>	3
10. W	♦ <u>J</u>	♠ 5	♠ 7	8
11. W	♣ <u>K</u>	9	♥ 8	4
12. W	♥ 6	J	<u>K</u>	♣ 5
13. E	♠ <u>J</u>	♣ Q	♥ 10	♥ 2

Down 3 — NS -150

**Board 342**  
 East Deals  
 N-S Vul

♠ J 4	♠ A 10 3 2	♠ K Q 6
♥ A K 8 3	♥ 10	♥ J 6 5 2
♦ K J 3	♦ A 10 8 4	♦ 9 7 6 2
♣ J 9 6 5	♣ 10 7 4 2	♣ K 8

♠ 9 8 7 5
♥ Q 9 7 4
♦ Q 5
♣ A Q 3

NS 2♠; S 1N; EW 1♥; S 1♦; NS 1♣; Par +110

West	North	East	South
<i>SaccoMan</i>	<i>ronpa</i>	<i>hjedda</i>	<i>jec</i>
		Pass	Pass
1 ♣	Pass	1 ♥	Pass
Pass	Dbl	Pass	1 ♠
2 ♥	Pass	Pass	2 ♠
Pass	Pass	Pass	

2 ♠ by South

<i>Trick</i>	<i>Lead</i>	<i>2nd</i>	<i>3rd</i>	<i>4th</i>
1. W	♥ <u>A</u>	10	2	4
2. W	♠ 4	2	<u>Q</u>	5
3. E	♣ K	<u>A</u>	6	2
4. S	♦ 5	3	<u>10</u>	6
5. N	♣ 4	8	<u>Q</u>	5
6. S	♣ 3	<u>J</u>	7	♥ 6
7. W	♠ J	<u>A</u>	6	7
8. N	♣ 10	♠ <u>K</u>	♥ 7	9
9. E	♦ 2	-	-	-

Made 3 — NS +140



**Board 344**  
 West Deals  
 Both Vul

<p>♠ K Q 8 7          ♥ A J 9 4 3          ♦ 2          ♣ K 9 2</p>		<p>♠ 5          ♥ 6 5          ♦ K 7 4 3          ♣ A Q J 10 4 3</p>	<p>♠ A J 10 9 6 4          ♥ 10 8          ♦ A 6          ♣ 7 6 5</p>
<p>♠ 3 2          ♥ K Q 7 2          ♦ Q J 10 9 8 5          ♣ 8</p>			

W 4♠; E 3♠; EW 3♥; NS 4♦; EW 2N; NS 3♣; Par -200; NS 5♦×-1

West	North	East	South
<i>SaccoMan</i>	<i>ronpa</i>	<i>hjemma</i>	<i>jec</i>
1 ♥	2 ♣	Dbl	2 ♦
2 ♠	4 ♦	4 ♠	5 ♦
Pass	Pass	Dbl	Pass
Pass	Pass		

5♦× by South

<i>Trick</i>	<i>Lead</i>	<i>2nd</i>	<i>3rd</i>	<i>4th</i>
1. W	♠ K	5	<u>A</u>	3
2. E	♥ 10	K	<u>A</u>	5
3. W	♥ J	6	8	<u>Q</u>
4. S	♦ 10	2	3	<u>A</u>
5. E	♠ J	2	7	<u>♦ 4</u>
6. N	♦ 7	6	<u>J</u>	♥ 3
7. S	♣ 8	2	<u>Q</u>	5
8. N	<u>♣ A</u>	6	♥ 2	9
9. N	♣ 3	7	<u>♦ 5</u>	K

Down 1 — NS -200

**Board 346**  
 East Deals  
 E-W Vul

♠ 7 4	♠ A J 10 5	♠ K 8
♥ A J	♥ Q	♥ 10 9 8 7 6 4 2
♦ 10 8 2	♦ K J 7 5 4 3	♦ —
♣ K 10 6 5 4 3	♣ 7 2	♣ A Q J 8
	<div style="display: inline-block; background-color: green; color: white; padding: 5px; text-align: center;">             N              W     E              S           </div>	
	♠ Q 9 6 3 2	
	♥ K 5 3	
	♦ A Q 9 6	
	♣ 9	

EW 4♥; EW 5♣; NS 3♠; NS 4♦; Par -100; NS 5♦×-1

West	North	East	South
<i>SaccoMan</i>	<i>ronpa</i>	<i>hjedda</i>	<i>jec</i>
		1 ♥	1 ♠
2 ♥	4 ♠	5 ♥	Pass
Pass	Dbl	Pass	Pass

Pass

5♥× by East

Trick	Lead	2nd	3rd	4th
1. S	♣ 9	3	2	<u>A</u>
2. E	♥ 2	3	<u>A</u>	Q
3. W	♥ J	♦ 3	4	<u>K</u>
4. S	♠ 9	4	<u>A</u>	8
5. N	♣ 7	J	<u>♥ 5</u>	4
6. S	♦ A	2	7	<u>♥ 6</u>
7. E	♥ 10	-	-	-

Down 1 — NS +200

**Board 347**  
 South Deals  
 Both Vul

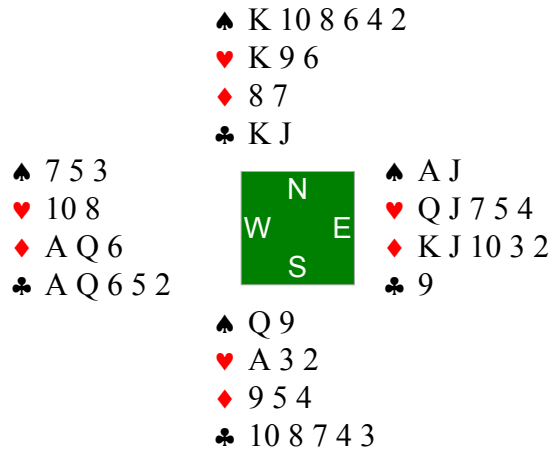

EW 4♥; EW 4♦; NS 2♠; EW 1N; EW 1♣; Par -500; NS 4♠×-2

West	North	East	South
<i>SaccoMan</i>	<i>ronpa</i>	<i>hjedda</i>	<i>jec</i>
			Pass
1 ♣	2 ♠	3 ♥	3 ♠
Pass	Pass	4 ♦	Pass
4 ♥	Pass	Pass	Pass

4 ♥ by East

<i>Trick</i>	<i>Lead</i>	<i>2nd</i>	<i>3rd</i>	<i>4th</i>
1. S	♠ Q	3	6	<u>A</u>
2. E	♣ 9	3	Q	<u>K</u>
3. N	♠ K	J	9	5
4. N	♠ 8	<u>♥ 7</u>	♦ 4	7
5. E	♦ 2	5	<u>A</u>	7
6. W	♥ 8	9	J	<u>A</u>
7. S	♣ 4	<u>A</u>	J	♦ 3
8. W	♥ 10	<u>K</u>	4	2
9. N	♠ 10	<u>♥ 5</u>	♦ 9	♣ 2
10. E	<u>♥ Q</u>	3	♣ 5	6
11. E	♦ 10	♣ 7	<u>Q</u>	8
12. W	♦ 6	♠ 2	<u>K</u>	♣ 8
13. E	<u>♦ J</u>	♣ 10	♣ 6	♠ 4

Down 1 — NS +100

**Board 348**  
 West Deals  
 None Vul

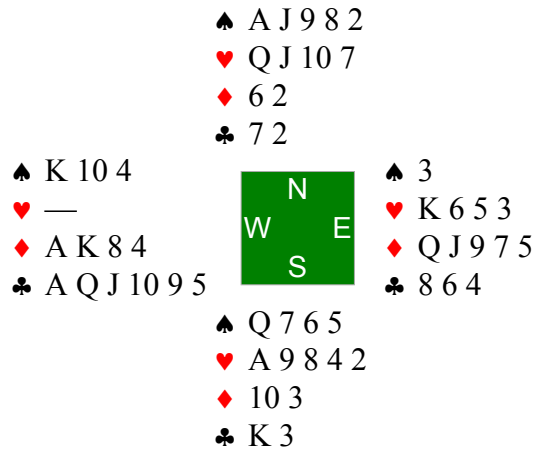

EW 6♦; EW 6♣; S 2♠; NS 2♥; N 1♠; Par -800: NS 6♥×-4;  
 S 6♠×-4

West	North	East	South
<i>SaccoMan</i>	<i>ronpa</i>	<i>hjedda</i>	<i>jec</i>
1 ♣	Pass	1 ♥	Pass
2 ♦	Pass	3 ♦	Pass
3 ♠	Dbl	5 ♦	Pass
Pass	Pass		

5 ♦ by West

Trick	Lead	2nd	3rd	4th
1. N	♥ Q	3	4	<u>♦ 4</u>
2. W	<u>♦ A</u>	2	5	3
3. W	♦ 8	6	<u>Q</u>	10
4. E	<u>♣ 8</u>	3	5	2
5. E	♣ 4	K	<u>A</u>	7
6. W	<u>♣ Q</u>	♠ 2	6	♥ 2

Made 7 — NS -440

**Board 350**  
 East Deals  
 Both Vul

♠ —	♠ A Q 7 6 5 2	♠ K J 10 9
♥ A K Q 3	♥ 8 6	♥ 7 5 4
♦ J 10 8 7 5 2	♦ K 9 6 4	♦ Q
♣ A K Q	♣ 5	♣ 8 7 4 3 2

W	N	E
	S	

♠ 8 4 3
♥ J 10 9 2
♦ A 3
♣ J 10 9 6

EW 3N; EW 3♥; EW 3♦; EW 3♣; NS 1♠; Par -600

West	North	East	South
<i>SaccoMan</i>	<i>ronpa</i>	<i>hjedda</i>	<i>jec</i>
		Pass	Pass
1 ♦	2 ♠	Pass	3 ♠
Dbl	Pass	Pass	Pass

3 ♠× by North

<i>Trick</i>	<i>Lead</i>	<i>2nd</i>	<i>3rd</i>	<i>4th</i>
1. E	♦ Q	<u>A</u>	5	4
2. S	♥ 2	<u>Q</u>	6	4
3. W	♦ J	K	<u>♠ 9</u>	3
4. E	♥ 7	9	<u>K</u>	8
5. W	♥ A	<u>♠ 5</u>	5	10
6. N	<u>♠ A</u>	10	3	♦ 2
7. N	♦ 6	<u>♠ J</u>	♣ 6	7
8. E	<u>♠ K</u>	4	♥ 3	2
9. E	♣ 2	9	<u>Q</u>	5
10. W	♣ K	-	-	-

Down 2 — NS -500

**Board 351**  
 South Deals  
 None Vul

♠ A K J 9 2	♠ Q 7 4 3	♠ 8
♥ 7 3	♥ 10 9 5 4	♥ A K J 8
♦ A K 4 3	♦ Q 7 2	♦ J 10 8 5
♣ A J	♣ 4 2	♣ Q 8 6 5

N	
W	E
S	

♠ 10 6 5
♥ Q 6 2
♦ 9 6
♣ K 10 9 7 3

EW 6♦; EW 5N; EW 5♠; EW 5♥; EW 4♣; Par -920

West	North	East	South
<i>SaccoMan</i>	<i>ronpa</i>	<i>hjemma</i>	<i>jec</i>
			Pass
2 NT	Pass	3 ♣	Dbl
3 ♠ <sup>1</sup>	Pass	3 NT	Pass
Pass	Pass		

1. 5

3 NT by West

<i>Trick</i>	<i>Lead</i>	<i>2nd</i>	<i>3rd</i>	<i>4th</i>
1. N	♣ 4	5	7	<u>J</u>
2. W	♦ A	2	5	6
3. W	♦ <u>K</u>	7	8	9
4. W	♦ 3	<u>Q</u>	10	♣ 3
5. N	♣ 2	6	9	<u>A</u>
6. W	♥ 3	4	J	<u>Q</u>
7. S	♣ <u>K</u>	♠ 2	♠ 3	8
8. S	♥ 6	7	-	-

Made 4 — NS -430

**Board 352**  
 West Deals  
 N-S Vul

♠ K 8 7	♠ 6 4	♠ Q 10 5 3
♥ A J 7 4	♥ Q 8 5 2	♥ K 9 6 3
♦ A Q 7 6 3	♦ K J	♦ 9 8 4
♣ 7	♣ A 9 6 5 3	♣ 8 4

♠ A J 9 2
♥ 10
♦ 10 5 2
♣ K Q J 10 2

EW 3♥; NS 4♣; NS 1N; EW 2♦; EW 1♠; Par +100; EW 4♥×-1

West	North	East	South
<i>SaccoMan</i>	<i>ronpa</i>	<i>hjedda</i>	<i>jec</i>
1 ♦	Pass	1 ♥	Dbl
3 ♥	4 ♣	Pass	Pass

Pass

4 ♣ by North

<i>Trick</i>	<i>Lead</i>	<i>2nd</i>	<i>3rd</i>	<i>4th</i>
1. E	♦ 4	2	<u>A</u>	J
2. W	♦ 3	<u>K</u>	9	5
3. N	♣ 3	4	<u>10</u>	7

Made 4 — NS +130

**Board 353**  
 North Deals  
 None Vul

♠ A Q 10 5 ♥ K 7 6 4 ♦ A K 3 ♣ 8 4		♠ J 4 3 2 ♥ A J 10 9 3 ♦ 10 6 ♣ 7 3	♠ 9 8 7 ♥ 8 2 ♦ 9 7 4 2 ♣ A K Q 5
		♠ K 6 ♥ Q 5 ♦ Q J 8 5 ♣ J 10 9 6 2	

EW 2N; EW 2♠; W 3♦; E 2♦; EW 1♥; EW 1♣; Par -120

West	North	East	South
<i>Harmon</i>	<i>BridgeGoth</i>	<i>canalla</i>	<i>jec</i>
	Pass	Pass	Pass
1 NT	2 ♣ <sup>1</sup>	Dbl	2 ♦
Pass	Pass	2 NT	Pass
Pass	Pass		

1. majors

2 NT by West

<i>Trick</i>	<i>Lead</i>	<i>2nd</i>	<i>3rd</i>	<i>4th</i>
1. N	♦ 10	2	5	<u>K</u>
2. W	♣ 4	3	<u>A</u>	6
3. E	♠ 7	K	<u>A</u>	2
4. W	♣ 8	7	<u>K</u>	2
5. E	<u>♣ Q</u>	9	♥ 4	♥ 9
6. E	♦ 9	J	<u>A</u>	6
7. W	♠ 10	<u>J</u>	8	6
8. N	♠ 4	9	♦ 8	<u>Q</u>
9. W	<u>♠ 5</u>	3	♣ 5	♣ 10
10. W	♥ 7	3	2	<u>Q</u>
11. S	<u>♦ Q</u>	3	♥ J	4
12. S	<u>♣ J</u>	♥ 6	♥ 10	♥ 8
13. S	♥ 5	K	<u>A</u>	♦ 7

Made 2 — NS -120



**Board 356**  
 West Deals  
 Both Vul

♠ J 5 3	♠ 9 7 6	♠ K 10 8 2
♥ J 8 7	♥ A 6 3 2	♥ Q 9
♦ K Q 4 2	♦ 7	♦ A J 10 9 8 3
♣ J 10 2	♣ A 9 8 6 4	♣ 5

♠ A Q 4
♥ K 10 5 4
♦ 6 5
♣ K Q 7 3

NS 5♥; NS 4♣; NS 1N; EW 2♦; NS 1♠; Par +650

West	North	East	South
<i>Harmon</i>	<i>BridgeGoth</i>	<i>danilo1</i>	<i>jec</i>
Pass	Pass	2♦	Dbl
Pass	3♦	Dbl	3♥
Pass	4♥	Pass	Pass

Pass

4♥ by South

<i>Trick</i>	<i>Lead</i>	<i>2nd</i>	<i>3rd</i>	<i>4th</i>
1. W	♦ <u>K</u>	7	J	5
2. W	♠ 3	6	K	<u>A</u>
3. S	♥ 4	7	<u>A</u>	9
4. N	♥ 3	Q	<u>K</u>	8
5. S	♦ 6	Q	♥ <u>2</u>	8
6. N	♣ 4	5	<u>K</u>	2
7. S	♣ <u>Q</u>	10	6	♦ 3
8. S	♣ 3	J	<u>A</u>	♦ 9

Made 5 — NS +650

**Board 358**  
 East Deals  
 E-W Vul

♠ K Q 9 7 6 2	<div style="background-color: green; color: white; padding: 10px; display: inline-block;">           N            W     E            S         </div>	♠ A 8 4
♥ K Q 7		♥ A 9 8 2
♦ 8 7		♦ J 9
♣ J 2		♣ Q 9 8 7

♠ J 5 3  
 ♥ 10 6 5 4  
 ♦ K 6 2  
 ♣ K 6 3

EW 3♠; EW 2♥; NS 3♦; NS 1♣; Par -100; NS 4♦×-1

West	North	East	South
<i>Harmon</i>	<i>BridgeGoth</i>	<i>danilo1</i>	<i>jec</i>
		Pass	Pass
2♠	3♦	3♠	Pass
Pass	Pass		

3♠ by West

<i>Trick</i>	<i>Lead</i>	<i>2nd</i>	<i>3rd</i>	<i>4th</i>
1. N	♥ J	2	4	<u>K</u>
2. W	♠ 2	10	<u>A</u>	3
3. E	♠ 4	5	<u>K</u>	♦ 5
4. W	♠ <u>Q</u>	♦ 3	8	J
5. W	♥ <u>Q</u>	3	8	5
6. W	♥ 7	♦ 4	<u>A</u>	6

Made 3 — NS -140

**Board 363**  
 South Deals  
 None Vul

♠ A 4	<div style="background-color: green; color: white; padding: 10px; display: inline-block;">           N W     E S         </div>	♠ K Q 9 7 5
♥ 6 2		♥ K 9 5 3
♦ K 6 3		♦ A Q 4
♣ J 9 7 5 3 2		♣ 4
	♠ 10 8 2	
	♥ A Q J 10 7	
	♦ 7 5 2	
	♣ A 10	

E 3♠; E 2N; W 2♠; W 1N; EW 1♥; EW 1♦; EW 1♣; Par -140

West	North	East	South
<i>Harmon</i>	<i>BridgeGoth</i>	<i>danilo1</i>	<i>jec</i>
Pass	Pass	1 ♠	2 ♥
Pass	Pass	Pass	Pass

2 ♥ by South

Trick	Lead	2nd	3rd	4th
1. W	♠ A	3	7	2
2. W	♠ 4	6	Q	8
3. E	♠ K	10	♣ 7	J
4. E	♣ 4	A	2	6
5. S	♥ A	2	4	3
6. S	♥ J	6	8	K
7. E	♠ 9	♦ 2	♣ 3	♦ 8
8. E	♠ 5	♦ 5	♣ 5	♦ 9
9. E	♦ A	7	3	10
10. E	♦ 4	♥ 7	6	J
11. S	♥ Q	♣ 9	♣ 8	5
12. S	♥ 10	♣ J	♣ Q	9
13. S	♣ 10	♦ K	K	♦ Q

Down 2 — NS -100

**Board 365**  
 North Deals  
 Both Vul

♠ Q 10 6 4 2	♠ 8 3	♠ A K 9
♥ A Q 4	♥ 9	♥ J 10 7 2
♦ A 8 4	♦ J 9 7 2	♦ K 10 6 3
♣ 9 3	♣ K J 6 5 4 2	♣ 10 7

♠ J 7 5
♥ K 8 6 5 3
♦ Q 5
♣ A Q 8

EW 4♠; EW 3♥; EW 3♦; EW 1N; NS 2♣; Par -620

West	North	East	South
<i>Harmon</i>	<i>BridgeGoth</i>	<i>danilo1</i>	<i>jec</i>
	Pass	1♦	1♥
1♠	Pass	2♠	Pass
4♠	Pass	Pass	Pass

4♠ by West

<i>Trick</i>	<i>Lead</i>	<i>2nd</i>	<i>3rd</i>	<i>4th</i>
1. N	♥ 9	J	3	4
2. E	♠ A	5	2	3
3. E	♠ K	7	4	8
4. E	♠ 9	J	Q	♣ 6
5. W	♦ A	2	3	5
6. W	♥ A	♣ 2	2	5
7. W	♥ Q	♣ 4	7	K

Made 4 — NS -620

**Board 367**  
 South Deals  
 N-S Vul

♠ A K Q J	♠ 8	♠ 10 5 4 3 2
♥ 8	♥ A K Q 10 7 6 3	♥ J 9
♦ K J 4 3	♦ Q 6	♦ 9 2
♣ Q 10 5 3	♣ 8 4 2	♣ A K 7 6

N	
W	E
S	

♠ 9 7 6
♥ 5 4 2
♦ A 10 8 7 5
♣ J 9

EW 5♠; EW 5♣; NS 3♥; EW 1♦; Par -450

West	North	East	South
<i>Harmon</i>	<i>BridgeGoth</i>	<i>danilo1</i>	<i>jec</i>
			Pass
1♦	4♥	Dbl	Pass
4♠	Pass	Pass	Pass

4♠ by West

Trick	Lead	2nd	3rd	4th
1. N	♥ K	9	2	8
2. N	♥ A	J	5	♠ J
3. W	♠ A	8	2	6
4. W	♠ K	♥ 6	3	7
5. W	♠ Q	♥ 3	4	9
6. W	♣ 3	8	♠ A	9
7. E	♦ 2	♠ A	3	6
8. S	♣ J	-	-	-

Made 5 — NS -450

**Board 368**  
 West Deals  
 E-W Vul

♠ 10 8 3 2		♠ A Q 7 6 5
♥ 8 6 4		♥ Q 2
♦ A J 9		♦ K 7
♣ Q 7 2		♣ K 9 8 6
♠ J 9 4		♠ K
♥ A 10 9 5 3	♥ K J 7	♦ 10 8 5 4 3 2
♦ Q 6	♦ 10 8 5 4 3 2	♣ J 10 5
♣ A 4 3	♣ J 10 5	

EW 3♠; NS 2♦; EW 2♣; NS 1♥; Par -140

West	North	East	South
<i>Harmon</i>	<i>BridgeGoth</i>	<i>danilo1</i>	<i>jec</i>
Pass	Pass	1 ♠	Pass
2 ♠	Pass	Pass	3 ♦
Pass	Pass	3 ♠	Pass
Pass	Pass		

3 ♠ by East

Trick	Lead	2nd	3rd	4th
1. S	♦ 5	J	Q	<u>K</u>
2. E	<u>♠ A</u>	K	2	4
3. E	♦ 7	8	<u>9</u>	6
4. W	♦ A	<u>♠ 9</u>	♥ 2	10
5. N	<u>♥ A</u>	Q	7	4
6. N	♥ 3	<u>♠ 5</u>	J	6
7. E	<u>♠ Q</u>	♦ 2	3	J
8. E	♣ 6	J	Q	<u>A</u>
9. N	♥ 10	<u>♠ 6</u>	K	8
10. E	♠ 7	♦ 3	<u>8</u>	♥ 5
11. W	♣ 2	3	8	<u>10</u>
12. S	♣ 5	-	-	-

Made 3 — NS -140

**Board 369**  
 North Deals  
 None Vul

♠ 9 6	♠ Q J 5 4	♠ 7 2
♥ K 10 6 5 4	♥ J 9 8 7	♥ A Q
♦ K J 8 3	♦ A 10 7 6	♦ Q 5 4 2
♣ 10 5	♣ 8	♣ K J 9 6 4

♠ A K 10 8 3
♥ 3 2
♦ 9
♣ A Q 7 3 2

NS 5♠; NS 2N; NS 2♣; EW 1♦; Par +450

West	North	East	South
<i>Harmon</i>	<i>BridgeGoth</i>	<i>danilo1</i>	<i>jec</i>
	Pass	1 ♣	1 ♠
Dbl	3 ♠	Pass	4 ♠
Pass	Pass	Pass	

4 ♠ by South

<i>Trick</i>	<i>Lead</i>	<i>2nd</i>	<i>3rd</i>	<i>4th</i>
1. W	♣ 10	8	6	<u>Q</u>
2. S	<u>♣ A</u>	5	♥ 7	4
3. S	♣ 2	♠ 9	<u>♠ J</u>	K
4. N	<u>♦ A</u>	2	9	3
5. N	♦ 6	4	<u>♠ 3</u>	8
6. S	♣ 3	♠ 6	<u>♠ Q</u>	9
7. N	♠ 4	2	<u>A</u>	♥ 5
8. S	♣ 7	♥ 4	<u>♠ 5</u>	J

Made 5 — NS +450

**Board 376**  
 West Deals  
 None Vul

♠ 10		♠ Q 5
♥ 8 3		♥ K Q 7
♦ J 8 7 5 4		♦ A Q 6 3
♣ A 9 7 5 3		♣ K J 6 4
♠ A K 9 8 7 6 3 2		♠ J 4
♥ J 10 2		♥ A 9 6 5 4
♦ —	♦ K 10 9 2	
♣ 8 2	♣ Q 10	

NS 3♠; EW 4♦; EW 3♣; NS 1♥; Par -100: NS 4♠×-1

West	North	East	South
<i>Harmon</i>	<i>BridgeGoth</i>	<i>danilo1</i>	<i>jec</i>
Pass	Pass	1 NT	4 ♠
4 NT <sup>1</sup>	Dbl	Pass	Pass
5 ♣	Dbl	Pass	Pass
Pass			

1. minors i hope

5 ♣× by West

<i>Trick</i>	<i>Lead</i>	<i>2nd</i>	<i>3rd</i>	<i>4th</i>
1. N	♠ J	5	2	10
2. N	♦ 2	3	♣ 2	4
3. S	♥ 2	3	<u>A</u>	7
4. N	♠ 4	Q	A	<u>♣ 3</u>
5. W	<u>♣ A</u>	10	4	8
6. W	♣ 5	Q	<u>K</u>	♥ 10

Down 2 — NS +300



**Board 380**  
 West Deals  
 N-S Vul

♠ K J 10 3 2		♠ Q 7 5
♥ A J 5		♥ K Q 10 9 7 2
♦ J 10 3		♦ —
♣ K 10		♣ Q 7 5 4
♠ A 9 6		♠ A 9 6
♥ 4	♥ 4	
♦ A Q 9 8 2	♦ A Q 9 8 2	
♣ A 8 6 3	♣ A 8 6 3	

EW 5♥; EW 4♠; NS 4♦; NS 1N; NS 1♣; Par -450

West	North	East	South
<i>Harmon</i>	<i>BridgeGoth</i>	<i>danilo1</i>	<i>jec</i>
1 ♠	Pass	2 ♥	Dbl
3 ♥	Pass	4 ♦	Pass
4 ♥	Pass	Pass	Pass

4 ♥ by East

<i>Trick</i>	<i>Lead</i>	<i>2nd</i>	<i>3rd</i>	<i>4th</i>
1. S	♣ 6	10	J	<u>Q</u>
2. E	♥ 2	4	<u>A</u>	6
3. W	♥ 5	3	<u>Q</u>	♦ 2
4. E	♠ 7	6	<u>10</u>	8
5. W	♠ 2	4	Q	<u>A</u>
6. S	<u>♣ A</u>	K	2	4
7. S	♦ A	3	7	<u>♥ 7</u>

Made 5 — NS -450

**Board 382**  
 East Deals  
 N-S Vul

♠ A 7 4 ♥ J 6 3 ♦ A 9 7 3 ♣ A J 2		♠ J 9 ♥ A K Q 8 7 ♦ K 8 ♣ K 10 6 3	♠ Q 10 6 3 ♥ 10 5 4 2 ♦ J 10 4 ♣ 5 4
		♠ K 8 5 2 ♥ 9 ♦ Q 6 5 2 ♣ Q 9 8 7	

NS 2♥; NS 3♣; NS 1N; NS 1♠; NS 1♦; Par +110

West	North	East	South
<i>pdc</i>	<i>ollina</i>	<i>smispi</i>	<i>jec</i>
		Pass	Pass
1♦	1♥	Pass	Pass
Dbl	Pass	1♠	Pass
Pass	2♣	Pass	Pass
Pass			

2♣ by North

<i>Trick</i>	<i>Lead</i>	<i>2nd</i>	<i>3rd</i>	<i>4th</i>
1. E	♦ J	2	<u>A</u>	8
2. W	♦ 3	<u>K</u>	4	5
3. N	♣ 3	4	Q	<u>A</u>
4. W	♣ 2	6	5	<u>7</u>
5. S	♣ 8	J	<u>K</u>	♠ 6
6. N	♥ <u>A</u>	4	9	3
7. N	♥ <u>K</u>	2	♠ 2	6

Made 4 — NS +130

**Board 385**  
 East Deals  
 E-W Vul

♠ 9 7 4	♠ 8 6	♠ A K Q J 10 2
♥ Q J 7 6 3	♥ 9	♥ 10 4 2
♦ K 9 5 4	♦ J 8 6 3 2	♦ Q
♣ 5	♣ K 10 9 6 2	♣ A 7 4

N	
W	E
S	

♠ 5 3
♥ A K 8 5
♦ A 10 7
♣ Q J 8 3

EW 3♠; EW 3♥; NS 3♣; EW 1N; NS 1♦; Par -100; NS 4♣×-1

West	North	East	South
<i>pdc</i>	<i>ollina</i>	<i>smispi</i>	<i>jec</i>
		1 ♠	Dbl
2 ♠	Pass	3 ♥	Pass
4 ♥	Pass	4 ♠	Pass
Pass	Pass		

4 ♠ by East

<i>Trick</i>	<i>Lead</i>	<i>2nd</i>	<i>3rd</i>	<i>4th</i>
1. S	<u>♥ A</u>	3	9	2
2. S	<u>♥ K</u>	6	♦ 2	4
3. S	<u>♦ A</u>	4	3	Q
4. S	♥ 8	7	<u>♠ 8</u>	10

Down 1 — NS +100

**Board 391**  
 West Deals  
 N-S Vul

♠ A Q J 6	♠ 10 8 7	♠ K 5
♥ 10 7 5 4	♥ J 6	♥ A 3 2
♦ A 3 2	♦ 10 8 7	♦ K Q J 9 5
♣ K 2	♣ 10 9 6 5 4	♣ J 8 3

♠ 9 4 3 2
♥ K Q 9 8
♦ 6 4
♣ A Q 7

EW 4N; EW 4♠; EW 5♦; EW 3♥; EW 2♣; Par -430

West	North	East	South
<i>pdc</i>	<i>ollina</i>	<i>smispi</i>	<i>jec</i>
1 ♦	Pass	2 ♦	Dbl
Pass	3 ♣ <sup>1</sup>	3 NT <sup>2</sup>	Pass
Pass	Pass		

1. i mislicked

2. no alert

3 NT by East

<i>Trick</i>	<i>Lead</i>	<i>2nd</i>	<i>3rd</i>	<i>4th</i>
1. S	♣ Q	<u>K</u>	6	3
2. W	♦ 2	8	<u>K</u>	4

Made 5 — NS -460

**Board 395**  
 West Deals  
 E-W Vul

♠ 8 3	♠ K J 6 5 2	♠ A
♥ A	♥ K J 7 6	♥ Q 10 9 8 5 2
♦ A Q 8 3 2	♦ K 10	♦ J 7
♣ Q 10 7 5 3	♣ 8 4	♣ A J 9 2

N	
W	E
S	

♠ Q 10 9 7 4
♥ 4 3
♦ 9 6 5 4
♣ K 6

EW 5♣; EW 3♥; EW 4♦; NS 2♠; EW 1N; Par -500: NS 5♠×-3

West	North	East	South
<i>pdc</i>	<i>ollina</i>	<i>smispi</i>	<i>jec</i>
1 ♦	1 ♠	2 ♥	4 ♠
5 ♣	Pass	Pass	Pass

5 ♣ by West

<i>Trick</i>	<i>Lead</i>	<i>2nd</i>	<i>3rd</i>	<i>4th</i>
1. N	♠ 2	<u>A</u>	10	3
2. E	♦ J	5	2	<u>K</u>
3. N	♠ 5	<u>♣ 2</u>	4	8
4. E	♦ 7	4	<u>A</u>	10
5. W	♣ Q	4	9	<u>K</u>
6. S	♣ 6	3	8	<u>J</u>
7. E	♥ 2	4	<u>A</u>	7
8. W	♦ 3	♠ 6	<u>♣ A</u>	6
9. E	♥ 5	3	<u>♣ 5</u>	6

Made 5 — NS -600

**Board 399**  
 West Deals  
 Both Vul

♠ 10 7 2 ♥ Q 2 ♦ A 9 7 ♣ A K 7 5 3	♠ A K 6 5 3 ♥ A 7 6 3 ♦ J 5 3 ♣ 9		♠ 9 8 4 ♥ J 10 9 8 5 ♦ Q 6 ♣ Q 10 2
♠ Q J ♥ K 4 ♦ K 10 8 4 2 ♣ J 8 6 4			

NS 3♠; NS 4♦; S 2N; NS 2♥; N 1N; NS 1♣; Par +140

West	North	East	South
<i>pd</i>	<i>ollina</i>	<i>smispi</i>	<i>jec</i>
1 ♣	1 ♠	Pass	1 NT
Pass	2 ♥	Pass	2 ♠
Pass	Pass	Pass	

2 ♠ by North

<i>Trick</i>	<i>Lead</i>	<i>2nd</i>	<i>3rd</i>	<i>4th</i>
1. E	♣ 2	4	<u>K</u>	9
2. W	♠ 2	3	4	<u>J</u>
3. S	<u>♠ Q</u>	7	5	8
4. S	♦ 2	7	J	<u>Q</u>
5. E	♥ J	4	2	<u>A</u>
6. N	<u>♠ A</u>	9	♣ 6	10
7. N	♦ 3	6	10	<u>A</u>
8. W	♣ 3	-	-	-

Made 4 — NS +170

**Board 400**  
 North Deals  
 None Vul

♠ A K 9 3 2 ♥ J 10 8 5 3 ♦ 6 ♣ J 7		♠ 8 7 4 ♥ A 7 6 4 ♦ 10 3 ♣ 10 9 5 2	♠ Q J 10 5 ♥ Q 2 ♦ K Q 7 5 ♣ K Q 3
♠ 6 ♥ K 9 ♦ A J 9 8 4 2 ♣ A 8 6 4			

EW 3♠; EW 2♥; NS 2♦; NS 2♣; Par -140

West	North	East	South
<i>Harmon</i>	<i>llorenzo</i>	<i>edrijver</i>	<i>jec</i>
	Pass	1 NT	3 ♦
4 ♦	Pass	4 ♠	Pass
Pass	Pass		

4 ♠ by East

<i>Trick</i>	<i>Lead</i>	<i>2nd</i>	<i>3rd</i>	<i>4th</i>
1. S	♦ A	6	10	5
2. S	♦ 8	♠ A	3	7
3. W	♠ 2	4	Q	6
4. E	♠ J	♦ 2	3	8
5. E	♠ 10	♣ 4	9	7
6. E	♦ K	4	♣ 7	♣ 2
7. E	♦ Q	9	♣ J	♣ 5
8. E	♥ 2	9	J	A
9. N	♣ 10	K	A	♠ K
10. W	♥ 3	4	Q	K
11. S	♣ 6	♥ 5	9	Q
12. E	♠ 5	♣ 8	♥ 8	♥ 6
13. E	♣ 3	♦ J	♥ 10	♥ 7

Made 4 — NS -420

**Board 403**  
 West Deals  
 Both Vul

♠ 7 4		♠ A K 10
♥ Q 5 4		♥ J 10 8 7
♦ 9 8 4 3 2		♦ K 10 5
♣ K 6 4		♣ Q 10 8
♠ J 9 8 6 5 2	<div style="display: inline-block; border: 1px solid black; background-color: #008000; color: white; padding: 5px; margin: 0 5px;">           N W     E S         </div>	
♥ 9 3		
♦ J 7 6		
♣ 7 5		
♠ Q 3		
♥ A K 6 2		
♦ A Q		
♣ A J 9 3 2		

NS 4♥; NS 5♣; NS 4♦; NS 1N; Par +620

West	North	East	South
<i>Harmon</i>	<i>llorenzo</i>	<i>edrijver</i>	<i>jec</i>
Pass	Pass	1 ♣	Dbl
Pass	1 ♦	Pass	2 NT
Pass	3 NT	Pass	Pass

Pass

3 NT by South

<i>Trick</i>	<i>Lead</i>	<i>2nd</i>	<i>3rd</i>	<i>4th</i>
1. W	♠ 6	4	<u>K</u>	3
2. E	<u>♠ A</u>	Q	5	7
3. E	♠ 10	♦ Q	<u>J</u>	♦ 2
4. W	<u>♠ 9</u>	♦ 3	♣ 10	♥ 2
5. W	<u>♠ 8</u>	♣ 4	♣ 8	♣ 2
6. W	<u>♠ 2</u>	♦ 4	♥ 7	♣ 3
7. W	♥ 9	4	8	<u>A</u>
8. S	<u>♥ K</u>	3	5	10
9. S	♥ 6	♣ 5	<u>Q</u>	J
10. N	♦ 8	5	<u>A</u>	7
11. S	♣ 9	7	<u>K</u>	Q

Down 2 — NS -200



**Board 412**  
 North Deals  
 Both Vul

♠ A J 9 5 4 ♥ Q 10 7 ♦ 6 ♣ 7 6 5 4		♠ 10 ♥ A J 9 4 ♦ J 5 4 2 ♣ A J 8 3	♠ 8 7 6 ♥ 5 ♦ A Q 10 3 ♣ K Q 10 9 2
♠ K Q 3 2 ♥ K 8 6 3 2 ♦ K 9 8 7 ♣ —			

NS 4♥; N 2N; NS 3♦; EW 3♣; S 1N; EW 1♠; Par +500; EW 5♣×-2

West	North	East	South
<i>Harmon</i>	<i>llorenzo</i>	<i>edrijver</i>	<i>jec</i>
	Pass	1 ♣	1 ♥
1 ♠	3 ♠	Pass	4 ♥
Pass	Pass	Pass	

4 ♥ by South

<i>Trick</i>	<i>Lead</i>	<i>2nd</i>	<i>3rd</i>	<i>4th</i>
1. W	♦ 6	2	<u>A</u>	9
2. E	♦ 3	K	<u>♥ 7</u>	4
3. W	♣ 4	<u>A</u>	2	♦ 7
4. N	<u>♥ A</u>	5	2	Q
5. N	<u>♥ J</u>	♣ 9	6	10
6. N	♠ 10	8	2	<u>J</u>
7. W	♣ 5	3	10	<u>♥ 3</u>
8. S	♠ K	A	<u>♥ 4</u>	6
9. N	♣ 8	Q	<u>♥ 8</u>	6

Down 1 — NS -100

**Board 416**  
 North Deals  
 None Vul

♠ A 10 7 5 2 ♥ A 8 5 2 ♦ 7 3 ♣ 4 2		♠ 8 4 ♥ 7 4 ♦ A J 5 ♣ J 10 7 6 5 3	♠ Q 3 ♥ Q 9 6 3 ♦ K Q 10 9 4 2 ♣ K
		♠ K J 9 6 ♥ K J 10 ♦ 8 6 ♣ A Q 9 8	

NS 3N; NS 4♣; EW 2♥; E 3♦; W 2♦; Par +100; E 4♦ × -1

West	North	East	South
<i>Harmon</i>	<i>llorenzo</i>	<i>edrijver</i>	<i>jec</i>
	Pass	1♦	Dbl
1♠	2♣	2♦	3♣
3♦	Pass	Pass	Pass

3♦ by East

<i>Trick</i>	<i>Lead</i>	<i>2nd</i>	<i>3rd</i>	<i>4th</i>
1. S	<u>♣ A</u>	2	3	K
2. S	♣ Q	4	5	<u>♦ 2</u>
3. E	♥ 3	10	<u>A</u>	4
4. W	♦ 3	5	<u>10</u>	6
5. E	♥ Q	<u>K</u>	2	7
6. S	♠ K	<u>A</u>	4	3
7. W	♦ 7	<u>A</u>	4	8
8. N	♠ 8	<u>Q</u>	6	2
9. E	<u>♦ K</u>	♣ 8	♠ 5	J
10. E	♥ 6	<u>J</u>	5	♣ 6

Made 3 — NS -110

**Board 417**  
 East Deals  
 N-S Vul

♠ A 7	♠ K 10 9 5 2	♠ J 8 6 4 3
♥ A 9 3	♥ Q J	♥ K 10 4 2
♦ J 10 4	♦ A K 7	♦ Q 9 5
♣ K 10 9 5 3	♣ J 6 4	♣ 7

♠ Q
♥ 8 7 6 5
♦ 8 6 3 2
♣ A Q 8 2

EW 2♥; EW 1N; EW 1♠; EW 1♣; Par -110

West	North	East	South
<i>Harmon</i>	<i>llorenzo</i>	<i>edrijver</i>	<i>jec</i>
		Pass	Pass
1 ♣	1 ♠	Dbl	Pass
1 NT	Pass	Pass	Pass

1 NT by West

<i>Trick</i>	<i>Lead</i>	<i>2nd</i>	<i>3rd</i>	<i>4th</i>
1. N	<u>♦ A</u>	5	6	4
2. N	<u>♦ K</u>	9	2	10
3. N	♦ 7	<u>Q</u>	3	J
4. E	♣ 7	2	9	<u>J</u>
5. N	♥ Q	<u>K</u>	6	3
6. E	♥ 2	5	9	<u>J</u>
7. N	♠ 2	J	Q	<u>A</u>
8. W	<u>♥ A</u>	♠ 5	4	7
9. W	♠ 7	<u>9</u>	3	♣ 8
10. N	♠ 10	4	♥ 8	♣ 3
11. N	<u>♠ K</u>	6	♣ Q	♣ 5
12. N	♣ 4	♥ 10	<u>A</u>	10
13. S	<u>♦ 8</u>	♣ K	♣ 6	♠ 8

Down 3 — NS +150

**Board 420**  
 North Deals  
 N-S Vul

♠ J 10 9 2 ♥ 9 7 ♦ K Q 3 ♣ 7 6 3 2	♠ K 7 6 4 ♥ A J 5 3 2 ♦ 5 ♣ 9 8 4		♠ 3 ♥ 10 8 6 4 ♦ A 10 9 4 ♣ A K J 10
♠ A Q 8 5 ♥ K Q ♦ J 8 7 6 2 ♣ Q 5			

NS 3♠; NS 2♥; EW 2♣; EW 1♦; Par +140

West	North	East	South
<i>Harmon</i>	<i>llorenzo</i>	<i>edrijver</i>	<i>jec</i>
	Pass	1 ♣	1 ♦
Pass	1 ♥	Pass	1 ♠
Pass	2 ♣	Pass	2 ♥
Pass	2 ♠	Pass	4 ♠
Pass	Pass	Pass	

4 ♠ by South

<i>Trick</i>	<i>Lead</i>	<i>2nd</i>	<i>3rd</i>	<i>4th</i>
1. W	♠ 9	4	3	<u>Q</u>
2. S	♦ J	<u>K</u>	5	4
3. W	♠ 10	6	♣ 10	<u>A</u>
4. S	♥ <u>Q</u>	7	2	4
5. S	♥ <u>K</u>	9	3	6
6. S	♦ 2	3	<u>♠ 7</u>	9
7. N	♥ A	8	♣ 5	<u>♠ 2</u>
8. W	♣ 2	4	<u>K</u>	<u>Q</u>
9. E	♥ 10	♦ 6	<u>♠ J</u>	5
10. W	♣ 3	-	-	-

Down 1 — NS -100

**Board 423**  
 West Deals  
 None Vul

♠ J 2 ♥ Q 10 7 ♦ 10 7 3 2 ♣ K 9 6 4		♠ K 8 4 3 ♥ 9 3 2 ♦ Q 9 8 6 ♣ J 8	♠ A 6 5 ♥ 6 5 ♦ A K J 5 ♣ A 10 7 2
♠ Q 10 9 7 ♥ A K J 8 4 ♦ 4 ♣ Q 5 3			

N 2♠; EW 3♣; EW 1N; EW 2♦; S 1♠; NS 1♥; Par -100: N 3♠×-1

West	North	East	South
<i>Harmon</i>	<i>llorenzo</i>	<i>edrijver</i>	<i>jec</i>
Pass	Pass	1 NT	2♣ <sup>1</sup>
Pass	2♠	Pass	Pass
Pass			

1. MM

2♠ by North

<i>Trick</i>	<i>Lead</i>	<i>2nd</i>	<i>3rd</i>	<i>4th</i>
1. E	<u>♦ A</u>	4	7	6
2. E	♠ 5	<u>9</u>	2	3
3. S	♠ Q	J	4	<u>A</u>
4. E	♠ 6	7	♦ 2	<u>8</u>
5. N	♥ 3	5	J	<u>Q</u>
6. W	♣ 4	8	<u>A</u>	3
7. E	♣ 2	5	<u>K</u>	J
8. W	♦ 3	8	J	<u>♠ 10</u>
9. S	♥ A	7	9	6

Made 2 — NS +110

**Board 426**  
 South Deals  
 None Vul

♠ A	♠ K J 10 5 4 3	♠ 7 6
♥ 10 7 5 3 2	♥ K Q	♥ A 6 4
♦ K 8 3	♦ 9 6	♦ A Q J 7 5 2
♣ A 9 5 4	♣ Q 10 2	♣ J 7

N	
W	E
S	

♠ Q 9 8 2
♥ J 9 8
♦ 10 4
♣ K 8 6 3

EW 4♥; EW 3N; EW 5♦; NS 1♠; EW 1♣; Par -420

West	North	East	South
<i>Harmon</i>	<i>llorenzo</i>	<i>edrijver</i>	<i>jec</i>
			Pass
1 ♥	1 ♠	2 ♦	3 ♠
Pass	Pass	4 ♥	Pass
Pass	Pass		

4 ♥ by West

Trick	Lead	2nd	3rd	4th
1. N	♠ 4	6	Q	<u>A</u>
2. W	♥ 2	<u>Q</u>	4	8
3. N	♣ 2	J	K	<u>A</u>
4. W	♥ 3	K	<u>A</u>	9
5. E	♥ 6	<u>J</u>	5	♠ 3
6. S	♣ 3	4	<u>10</u>	7
7. N	<u>♣ Q</u>	♠ 7	6	5
8. N	♠ K	-	-	-

Down 1 — NS +50

**Board 429**  
 East Deals  
 N-S Vul

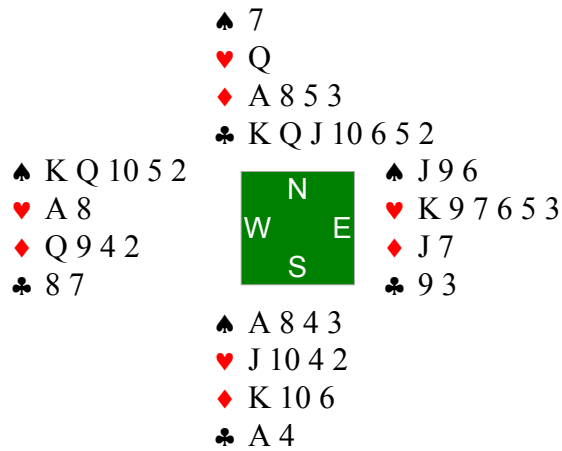

NS 4N; NS 5♣; NS 3♦; EW 1♠; NS 1♥; Par +630

West	North	East	South
<i>kriegel</i>	<i>BridgeGoth</i>	<i>shengabus</i>	<i>jec</i>
		2 ♥	Pass
Pass	5 ♣	Pass	6 ♣
Pass	Pass	Pass	

6 ♣ by North

<i>Trick</i>	<i>Lead</i>	<i>2nd</i>	<i>3rd</i>	<i>4th</i>
1. E	♦ J	<u>K</u>	2	3
2. S	♥ 2	<u>A</u>	Q	3
3. W	♠ K	7	6	<u>A</u>
4. S	♥ J	8	♦ 5	<u>K</u>
5. E	♦ 7	6	9	<u>A</u>
6. N	<u>♣ K</u>	3	4	7
7. N	♣ 2	9	<u>A</u>	8

Down 1 — NS -100





**Board 432**  
 North Deals  
 N-S Vul

♠ J 10 4 ♥ K 8 4 ♦ 9 7 5 ♣ 10 9 6 3	♠ 9 7 5 3 2 ♥ J 10 6 2 ♦ 6 3 ♣ K 4	<div style="text-align: center; border: 1px solid black; width: 40px; height: 40px; margin: 0 auto; background-color: #006400; color: white; display: flex; flex-direction: column; align-items: center; justify-content: center;"> <span>N</span> <span>W</span> <span>E</span> <span>S</span> </div>	♠ A Q 6 ♥ 9 7 3 ♦ A ♣ A Q J 8 5 2
	♠ K 8 ♥ A Q 5 ♦ K Q J 10 8 4 2 ♣ 7		

EW 4♣; NS 2♦; EW 1♠; N 1♥; Par -130

West	North	East	South
<i>kriegel</i>	<i>BridgeGoth</i>	<i>shengabus</i>	<i>jec</i>
	Pass	1 ♣ <sup>1</sup>	1 ♦
Pass	Pass	Dbl	Rdbl
2 ♣	Pass	Pass	2 ♦
Pass	Pass	3 ♣	Pass
Pass	Pass		

1. 11-14 bal or ♣

3 ♣ by East

Trick	Lead	2nd	3rd	4th
1. S	♦ K	5	6	<u>A</u>
2. E	♥ 3	5	<u>K</u>	2
3. W	<u>♣ 9</u>	4	2	7
4. W	♦ 7	3	<u>♣ J</u>	2
5. E	<u>♣ A</u>	♦ 4	3	K
6. E	<u>♣ 8</u>	♦ 8	<u>10</u>	♠ 2
7. W	♦ 9	♠ 3	<u>♣ Q</u>	Q
8. E	♥ 7	<u>A</u>	4	6
9. S	<u>♥ Q</u>	8	10	9
10. S	♠ K	-	-	-

Made 5 — NS -150

**Board 435**  
 West Deals  
 None Vul

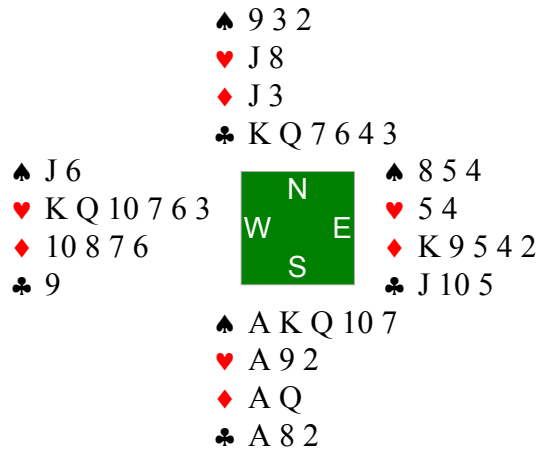

NS 7N; NS 7♠; NS 7♣; EW 1♦; Par +1520

West	North	East	South
<i>kriegel</i>	<i>BridgeGoth</i>	<i>shengabus</i>	<i>jec</i>
2♥	Pass	Pass	Dbl
Pass	3♣	Pass	3♠
Pass	4♥	Pass	5NT <sup>1</sup>
Pass	7♣	Pass	Pass

1. pick a slam

7♣ by North

Trick	Lead	2nd	3rd	4th
1. E	♦ 4	<u>A</u>	6	J
2. S	<u>♣ A</u>	9	3	10
3. S	♣ 2	♥ 3	<u>K</u>	5
4. N	♠ 2	5	<u>A</u>	6
5. S	<u>♠ K</u>	J	9	4
6. S	♣ 8	♥ 6	Q	J

Made 7 — NS +1440

**Board 449**  
 East Deals  
 E-W Vul

♠ K 6	♠ Q 10 5 4 2	♠ J 9 8 7 3
♥ K J 8 7 4	♥ A 10 9	♥ Q 6 3
♦ K J 10 6	♦ A 4 2	♦ 9 3
♣ A Q	♣ 10 2	♣ K J 4

N	
W	E
S	

♠ A
♥ 5 2
♦ Q 8 7 5
♣ 9 8 7 6 5 3

EW 3N; EW 3♥; EW 2♠; EW 1♦; Par -600

West	North	East	South
<i>kriegel</i>	<i>BridgeGoth</i>	<i>shengabus</i>	<i>jec</i>
		Pass	Pass
1 ♥	1 ♠	2 ♥	Dbl <sup>1</sup>
4 ♥	Pass	Pass	Pass

1. to

4 ♥ by West

<i>Trick</i>	<i>Lead</i>	<i>2nd</i>	<i>3rd</i>	<i>4th</i>
1. N	♠ 2	3	<u>A</u>	6
2. S	♦ 5	6	<u>A</u>	3
3. N	♠ 5	7	<u>♥ 2</u>	K
4. S	♣ 5	<u>A</u>	2	4
5. W	♥ 4	9	<u>Q</u>	5
6. E	♥ 3	♣ 3	K	<u>A</u>
7. N	♥ 10	6	♣ 6	<u>J</u>
8. W	♣ Q	10	<u>K</u>	7
9. E	♣ J	8	♦ 10	♦ 2
10. E	♦ 9	7	<u>J</u>	4

Down 1 — NS +100

**Board 453**  
 East Deals  
 Both Vul

♠ K 7 6 3	<div style="background-color: green; color: white; padding: 10px; display: inline-block;">           N W     E S         </div>	♠ A J 8 2
♥ 9 8 5 4 2		♥ Q J 3
♦ —		♦ Q 9 7 6 4
♣ 7 6 5 3		♣ Q
		♠ Q 9 5 4
		♥ A 10 7
		♦ A K 2
		♣ 10 9 8

NS 5N; S 5♣; NS 4♦; N 4♣; EW 1♠; NS 1♥; Par +660

West	North	East	South
<i>kriegel</i>	<i>BridgeGoth</i>	<i>shengabus</i>	<i>jec</i>
		1 ♦ <sup>1</sup>	Pass
1 ♥	2 ♣	Dbl <sup>2</sup>	2 ♦
2 ♥	Pass	Pass	3 ♣
Pass	Pass	Pass	

1. usually unbal, if weak nt shows 5

2. 3

3 ♣ by North

Trick	Lead	2nd	3rd	4th
1. E	♥ Q	7	9	<u>K</u>
2. N	<u>♣ A</u>	Q	8	3
3. N	♣ 2	♦ 7	<u>9</u>	5
4. S	♣ 10	6	<u>J</u>	♦ 4
5. N	<u>♣ K</u>	♠ 2	♠ 4	7
6. N	♥ 6	3	<u>10</u>	2
7. S	<u>♥ A</u>	4	♠ 10	J
8. S	♦ A	♠ 3	-	-

Made 6 — NS +170

**Board 455**  
 West Deals  
 N-S Vul

♠ 10 6 2	♠ J 4 3	♠ 9 5
♥ J 10 7	♥ A 9 3	♥ K 2
♦ K J 8	♦ A 7 3 2	♦ Q 10 9 4
♣ A K 10 8	♣ J 3 2	♣ Q 9 7 6 4

♠ A K Q 8 7
♥ Q 8 6 5 4
♦ 6 5
♣ 5

NS 4♠; NS 4♥; EW 3♣; NS 1N; EW 1♦; Par +300; EW 5♣×-2

West	North	East	South
<i>kriegel</i>	<i>BridgeGoth</i>	<i>shengabus</i>	<i>jec</i>
1 ♣ <sup>1</sup>	Pass	1 ♠ <sup>2</sup>	Pass
1 NT	Pass	Pass	Dbl
Pass	Pass	2 ♣	Dbl
Pass	2 ♠	Pass	Pass
Pass			

1. clubs or 11-bad 14 bal

2. transfer to 1 NT, usually 5-10 hcp, or D

2 ♠ by North

<i>Trick</i>	<i>Lead</i>	<i>2nd</i>	<i>3rd</i>	<i>4th</i>
1. E	♣ 6	5	<u>K</u>	2
2. W	♠ 2	3	9	<u>K</u>
3. S	♥ 4	10	<u>A</u>	2
4. N	♥ 3	<u>K</u>	5	7
5. E	♦ 10	5	K	<u>A</u>
6. N	♠ J	5	7	6
7. N	♠ 4	♣ 4	-	-

Made 4 — NS +170

**Board 456**  
 North Deals  
 None Vul

♠ 9 7	♠ 10 6 4 3	♠ Q J 5
♥ 9 3	♥ 8 7 5 4	♥ K Q 2
♦ 9 5 2	♦ 10 4 3	♦ K J 6
♣ 8 7 5 4 3 2	♣ 10 6	♣ K Q J 9
	<div style="display: inline-block; border: 1px solid black; background-color: #006400; color: white; padding: 5px; text-align: center; margin: 5px;">             N              W     E              S           </div>	
	♠ A K 8 2	
	♥ A J 10 6	
	♦ A Q 8 7	
	♣ A	

NS 4♠; NS 4♥; NS 2N; NS 3♦; EW 1♣; Par +420

West	North	East	South
<i>thejuwel</i>	<i>smispi</i>	<i>gateway</i>	<i>jec</i>
	Pass	1 NT <sup>1</sup>	Dbl <sup>2</sup>
Rdbl <sup>3</sup>	Pass	2 ♣	Dbl
Pass	2 ♥	Pass	4 ♥
Pass	Pass	Pass	

1. 15-17
2. penalty
3. to bid !2 ♣ i hope

4 ♥ by North

Trick	Lead	2nd	3rd	4th
1. E	♣ K	<u>A</u>	5	10
2. S	♥ 10	3	5	<u>Q</u>
3. E	♣ Q	<u>♥ 6</u>	7	6
4. S	<u>♠ A</u>	7	3	5
5. S	<u>♠ K</u>	9	4	J
6. S	♠ 2	♦ 5	6	<u>Q</u>
7. E	♦ J	<u>Q</u>	2	4
8. S	<u>♦ A</u>	9	3	6
9. S	♦ 7	<u>♥ 9</u>	10	K
10. W	♣ 2	<u>♥ 4</u>	9	♦ 8
11. N	♥ 7	2	<u>J</u>	♣ 3
12. S	♥ A	♣ 4	-	-

Made 4 — NS +420

**Board 459**  
 West Deals  
 Both Vul

♠ Q 7 6 5 4 2 ♥ K 3 ♦ Q ♣ Q J 8 4		♠ A K 10 ♥ A 7 6 5 2 ♦ 7 ♣ A K 6 5	♠ J 3 ♥ J 4 ♦ J 10 9 6 3 ♣ 9 7 3 2
		♠ 9 8 ♥ Q 10 9 8 ♦ A K 8 5 4 2 ♣ 10	

NS 6♥; NS 4N; NS 4♦; NS 2♠; N 3♣; S 2♣; Par +1430

West	North	East	South
<i>thejuwel</i>	<i>smispi</i>	<i>gateway</i>	<i>jec</i>
2 ♠	Dbl	Pass	3 ♥
Pass	3 ♠	Pass	4 ♦
Pass	4 NT	Pass	5 ♦
Pass	6 ♥	Pass	Pass

6 ♥ by South

<i>Trick</i>	<i>Lead</i>	<i>2nd</i>	<i>3rd</i>	<i>4th</i>
1. W	♣ 4	<u>A</u>	2	10
2. N	♥ 2	4	Q	<u>K</u>
3. W	♥ 3	<u>A</u>	J	8
4. N	♦ 7	6	<u>A</u>	Q
5. S	♦ <u>K</u>	♠ 2	♣ 5	3
6. S	♦ 2	♠ 4	♥ <u>5</u>	9
7. N	♣ <u>K</u>	3	♦ 4	8
8. N	♣ 6	7	♥ <u>9</u>	J
9. S	♠ 8	5	<u>K</u>	3
10. N	♠ <u>A</u>	J	9	6
11. N	♠ 10	♣ 9	♥ <u>10</u>	Q

Made 6 — NS +1430

**Board 464**  
 North Deals  
 E-W Vul

♠ A K	♠ 10 5	♠ Q J 9 7 4 3
♥ J 8	♥ Q 9 7 6 4	♥ A K 3 2
♦ Q 7 2	♦ A 6 5	♦ 8
♣ A K Q 8 5 3	♣ 7 4 2	♣ J 9

N	
W	E
S	

♠ 8 6 2
♥ 10 5
♦ K J 10 9 4 3
♣ 10 6

EW 6♠; EW 6♣; W 4N; EW 3♥; E 1N; EW 1♦; Par -1430

West	North	East	South
<i>thejuwel</i>	<i>smispi</i>	<i>gateway</i>	<i>jec</i>
	Pass	1 ♠	Pass
2 ♣	Pass	2 ♥	Pass
3 ♣	Pass	3 ♠	Pass
4 ♦	Dbl	Pass	Pass
4 ♠	Pass	Pass	Pass

4 ♠ by East

Trick	Lead	2nd	3rd	4th
1. S	♦ 10	2	<u>A</u>	8
2. N	♦ 6	<u>♠ 3</u>	3	7
3. E	♠ 4	6	<u>A</u>	5
4. W	<u>♠ K</u>	10	7	2
5. W	♥ 8	4	<u>A</u>	5
6. E	<u>♠ Q</u>	8	♥ J	♥ 6
7. E	♣ J	10	-	-

Made 6 — NS -680



**Board 465**  
 East Deals  
 Both Vul

♠ A K 10 5 2 ♥ 8 ♦ J 10 4 2 ♣ J 10 6		♠ Q 9 ♥ K 6 4 3 ♦ A K Q 6 5 ♣ K Q	♠ 8 7 3 ♥ A 9 7 5 2 ♦ 9 3 ♣ A 4 2
♠ J 6 4 ♥ Q J 10 ♦ 8 7 ♣ 9 8 7 5 3			

EW 3♠; NS 1N; NS 1♥; NS 1♦; NS 1♣; Par -140

West	North	East	South
<i>thejuwel</i>	<i>smispi</i>	<i>gateway</i>	<i>jec</i>
		Pass	Pass
2 ♠	Dbl	3 ♠	Pass
Pass	Pass		

3 ♠ by West

<i>Trick</i>	<i>Lead</i>	<i>2nd</i>	<i>3rd</i>	<i>4th</i>
1. N	<u>♦ A</u>	3	8	4
2. N	<u>♦ K</u>	9	7	2
3. N	♣ K	<u>A</u>	3	6
4. E	♣ 2	5	J	<u>Q</u>
5. N	♦ 5	♠ 3	<u>♠ 4</u>	10
6. S	♣ 7	10	<u>♠ 9</u>	4
7. N	♦ Q	♠ 7	<u>♠ J</u>	J
8. S	♠ 6	<u>K</u>	Q	8

Down 2 — NS +200

**Board 469**  
 East Deals  
 None Vul

♠ Q 10 2 ♥ K J 2 ♦ J 10 5 3 ♣ 8 7 3		♠ 8 7 5 ♥ A 10 9 6 ♦ A K 8 2 ♣ 5 4	♠ A K J 9 6 3 ♥ 4 3 ♦ 6 4 ♣ A K J
♠ 4 ♥ Q 8 7 5 ♦ Q 9 7 ♣ Q 10 9 6 2			

W 3N; EW 3♠; NS 3♥; E 2N; NS 1♦; NS 1♣; Par -100; NS 4♥×-1

West	North	East	South
<i>thejuwel</i>	<i>smispi</i>	<i>gateway</i>	<i>jec</i>
		1 ♠	Pass
2 ♠	Dbl	4 ♠	5 ♣
Pass	Pass	Dbl	Pass
Pass	Pass		

5 ♣× by South

<i>Trick</i>	<i>Lead</i>	<i>2nd</i>	<i>3rd</i>	<i>4th</i>
1. W	♠ 2	5	<u>K</u>	4
2. E	♠ 3	<u>♣ 2</u>	10	7
3. S	♦ 7	3	<u>K</u>	4
4. N	♥ 6	3	7	<u>J</u>
5. W	♥ 2	<u>9</u>	4	5
6. N	♣ 4	<u>K</u>	6	3
7. E	♠ A	<u>♣ 9</u>	Q	8
8. S	♦ Q	5	2	6
9. S	♦ 9	10	A	<u>♣ J</u>
10. E	<u>♣ A</u>	10	7	5
11. E	♠ J	<u>♣ Q</u>	♥ K	♦ 8
12. S	♥ 8	<u>♣ 8</u>	10	♠ 6
13. W	<u>♦ J</u>	♥ A	♠ 9	♥ Q

Down 5 — NS -1100

**Board 470**  
 South Deals  
 N-S Vul

♠ Q 7 ♥ K Q J 8 7 6 ♦ 6 5 ♣ J 4 2		♠ A 10 8 5 4 ♥ — ♦ K Q 9 4 3 ♣ K 6 3	♠ J 9 ♥ A 5 2 ♦ A J 10 7 ♣ A 10 9 5
♠ K 6 3 2 ♥ 10 9 4 3 ♦ 8 2 ♣ Q 8 7			

NS 4♠; EW 4♥; EW 2N; NS 2♦; EW 1♣; Par +100; EW 5♥×-1

West	North	East	South
<i>thejuwel</i>	<i>smispi</i>	<i>gateway</i>	<i>jec</i>
			Pass
2♥	2♠	4♥	4♠
Pass	Pass	Dbl	Pass
Pass	Pass		

4♠× by North

<i>Trick</i>	<i>Lead</i>	<i>2nd</i>	<i>3rd</i>	<i>4th</i>
1. E	♠ 9	2	7	<u>10</u>
2. N	♦ K	<u>A</u>	2	5
3. E	♠ J	3	Q	<u>A</u>
4. N	♦ <u>Q</u>	7	8	6
5. N	♦ 3	10	<u>♠ 6</u>	♥ 8
6. S	♣ 7	2	K	<u>A</u>
7. E	♥ A	3	6	<u>♠ 4</u>
8. N	♦ 4	J	<u>♠ K</u>	♥ 7

Made 4 — NS +790

**Board 478**  
 South Deals  
 E-W Vul

♠ A J 3 ♥ K Q 10 2 ♦ K 8 4 ♣ 10 8 2		♠ K 9 5 ♥ A 9 8 7 3 ♦ A 7 2 ♣ 9 5	♠ 10 7 2 ♥ J 5 ♦ Q 10 9 6 5 ♣ K 6 4
♠ Q 8 6 4 ♥ 6 4 ♦ J 3 ♣ A Q J 7 3			

NS 3♠; NS 2N; NS 2♥; NS 3♣; Par +140

West	North	East	South
<i>thejuwel</i>	<i>smispi</i>	<i>EdoWell</i>	<i>jec</i>
			Pass
1 ♣	1 ♥	Pass	1 NT
Pass	Pass	Pass	

1 NT by South

<i>Trick</i>	<i>Lead</i>	<i>2nd</i>	<i>3rd</i>	<i>4th</i>
1. W	♦ 4	2	<u>Q</u>	3
2. E	♦ 10	J	<u>K</u>	7
3. W	♦ 8	<u>A</u>	6	♠ 4
4. N	♣ 5	6	<u>Q</u>	2
5. S	♠ 6	3	<u>K</u>	2
6. N	♠ 5	7	8	<u>J</u>
7. W	♥ Q	<u>A</u>	5	4
8. N	♣ 9	4	<u>A</u>	10
9. S	♣ 3	8	♥ 3	<u>K</u>
10. E	♦ 5	-	-	-

Down 2 — NS -100

**Board 483**  
 West Deals  
 None Vul

♠ 10 9 6 4 2	♠ 8	♠ K Q J 7 3
♥ A J	♥ K 6	♥ 7 3
♦ K J 9	♦ A Q 10 7 5	♦ 8 6 3 2
♣ A K 2	♣ J 10 8 7 5	♣ 9 4

N	
W	E
S	

♠ A 5
♥ Q 10 9 8 5 4 2
♦ 4
♣ Q 6 3

NS 3♥; NS 4♣; EW 2♠; NS 1♦; Par +130

West	North	East	South
<i>thejuwel</i>	<i>smispi</i>	<i>EdoWell</i>	<i>jec</i>
1 NT	Pass	2♥	3♥
4♠	Dbl	Pass	Pass
Pass			

4♠× by West

<i>Trick</i>	<i>Lead</i>	<i>2nd</i>	<i>3rd</i>	<i>4th</i>
1. N	<u>♥K</u>	3	8	J
2. N	♥6	7	10	<u>A</u>
3. W	♠2	8	K	<u>A</u>
4. S	♦4	9	<u>Q</u>	2
5. N	<u>♦A</u>	3	♥2	K
6. N	♦5	6	<u>♠5</u>	J
7. S	♣3	-	-	-

Down 2 — NS +300

**Board 490**  
 South Deals  
 E-W Vul

♠ Q 10 3	♠ A 9 8 7 6 4	♠ K
♥ J 10 6 4 2	♥ 7 5	♥ K Q 9 8
♦ K J 6 3	♦ Q 2	♦ 10 8 7 4
♣ A	♣ Q 7 6	♣ K 9 8 5

♠ J 5 2
♥ A 3
♦ A 9 5
♣ J 10 4 3 2

EW 3♥; EW 3♦; EW 1N; NS 1♠; NS 1♣; Par -140

West	North	East	South
<i>bitran</i>	<i>ronpa</i>	<i>Rashid_K</i>	<i>jec</i>
			Pass
1 ♥	2 ♠	3 ♠	4 ♠
Pass	Pass	Dbl	Pass
Pass	Pass		

4 ♠× by North

<i>Trick</i>	<i>Lead</i>	<i>2nd</i>	<i>3rd</i>	<i>4th</i>
1. E	♥ K	<u>A</u>	2	5
2. S	♠ 2	3	<u>A</u>	K
3. N	♠ 4	♦ 4	J	<u>Q</u>
4. W	<u>♠ 10</u>	6	♥ 8	5
5. W	♥ 6	7	<u>9</u>	3
6. E	♦ 7	5	<u>K</u>	2
7. W	♦ 3	<u>Q</u>	8	9
8. N	♣ 6	9	J	<u>A</u>
9. W	♥ J	<u>♠ 7</u>	Q	♣ 2
10. N	♣ 7	<u>K</u>	3	♦ 6
11. E	♣ 5	-	-	-

Down 3 — NS -500

**Board 495**  
 West Deals  
 None Vul

♠ J 10	♠ A 5 3 2	♠ 9 8 7
♥ A 6 5	♥ J 10 7 4	♥ 9 8 3
♦ A 4	♦ K Q 10 8	♦ J 9 2
♣ Q J 10 7 5 4	♣ 6	♣ A K 8 2
	♠ K Q 6 4	
	♥ K Q 2	
	♦ 7 6 5 3	
	♣ 9 3	

NS 4♠; NS 4♦; EW 2N; NS 2♥; EW 2♣; Par +300; EW 4N×-2

West	North	East	South
<i>bitran</i>	<i>ronpa</i>	<i>Rashid_K</i>	<i>jec</i>
1 ♣	Dbl	2 ♣	Dbl
4 ♣	Pass	Pass	4 ♠
Pass	Pass	Pass	

4 ♠ by South

<i>Trick</i>	<i>Lead</i>	<i>2nd</i>	<i>3rd</i>	<i>4th</i>
1. W	♣ Q	6	<u>K</u>	9
2. E	♥ 9	2	<u>A</u>	4
3. W	♥ 6	7	8	<u>K</u>
4. S	♠ Q	10	2	8
5. S	♠ 4	J	<u>A</u>	7
6. N	♠ 3	9	<u>K</u>	♣ 4
7. S	♦ 3	<u>A</u>	8	2
8. W	♦ 4	<u>K</u>	9	5

Made 4 — NS +420

**Board 498**  
 South Deals  
 None Vul

♠ Q 10 3 ♥ 7 4 ♦ A Q J ♣ K J 9 7 3	♠ A K 9 ♥ K 10 6 ♦ K 10 7 6 5 ♣ 8 4	<div style="text-align: center; border: 1px solid black; width: 40px; height: 40px; margin: 0 auto; background-color: #006400; color: white; display: flex; flex-direction: column; align-items: center; justify-content: center;"> <span>N</span> <span>W</span> <span>E</span> <span>S</span> </div>	♠ 8 7 6 5 2 ♥ Q J 3 ♦ 9 8 4 ♣ A 6
♠ J 4 ♥ A 9 8 5 2 ♦ 3 2 ♣ Q 10 5 2			

NS 3♥; NS 1N; NS 1♦; NS 1♣; Par +140

West	North	East	South
<i>bitran</i>	<i>ronpa</i>	<i>Rashid_K</i>	<i>jec</i>
			Pass
1 ♣	1 ♦	1 ♠	Dbl
Pass	1 NT	Pass	Pass
2 ♣	Pass	Pass	Pass

2 ♣ by West

<i>Trick</i>	<i>Lead</i>	<i>2nd</i>	<i>3rd</i>	<i>4th</i>
1. N	<u>♠ A</u>	2	J	3
2. N	<u>♠ K</u>	5	4	10
3. N	♠ 9	6	<u>♣ 2</u>	Q
4. S	♦ 3	Q	<u>K</u>	4
5. N	<u>♥ K</u>	3	9	4
6. N	♥ 6	J	<u>A</u>	7
7. S	♥ 8	<u>♣ 9</u>	10	Q
8. W	♣ 3	4	<u>A</u>	5
9. E	♣ 6	10	<u>J</u>	8
10. W	<u>♣ K</u>	♦ 5	♦ 8	Q

Down 1 — NS +50



**Board 511**  
 West Deals  
 None Vul

♠ Q 8 7 4 2	♠ 9 3	♠ 10
♥ 9	♥ Q 10 8 7 4 3	♥ A J 6 5 2
♦ K Q J	♦ 8 5 3	♦ 4 2
♣ K J 10 6	♣ Q 7	♣ A 9 5 4 2

N	
W	E
S	

♠ A K J 6 5
♥ K
♦ A 10 9 7 6
♣ 8 3

EW 4♣; EW 2N; EW 1♠; EW 1♥; Par -130

West	North	East	South
<i>bitran</i>	<i>ronpa</i>	<i>Rashid_K</i>	<i>jec</i>
1 ♠	Pass	1 NT	Pass
2 ♣	Pass	3 ♣	3 ♦
Pass	Pass	3 ♥	Pass
4 ♣	Pass	Pass	Pass

4 ♣ by West

Trick	Lead	2nd	3rd	4th
1. N	♦ 3	2	<u>A</u>	Q
2. S	<u>♠ A</u>	2	3	10
3. S	♦ 10	<u>K</u>	5	4
4. W	<u>♦ J</u>	8	♥ 2	6
5. W	♥ 9	3	<u>A</u>	K
6. E	♥ 5	♦ 7	<u>♣ 6</u>	7
7. W	♠ 4	9	<u>♣ 2</u>	5
8. E	♥ 6	♦ 9	<u>♣ 10</u>	4
9. W	♠ 7	♣ Q	<u>♣ A</u>	6
10. E	♥ J	♠ J	<u>♣ J</u>	8
11. W	♠ 8	♣ 7	<u>♣ 9</u>	K
12. E	♣ 4	3	<u>K</u>	♥ 10
13. W	♠ Q	♥ Q	♣ 5	<u>♣ 8</u>

Made 4 — NS -130

**Board 513**  
 East Deals  
 Both Vul

♠ K Q J 10 2	♠ 8	♠ 9 7 5 4 3
♥ 8 7	♥ A Q 6 3	♥ K J 10 5
♦ A 9 8 5 3	♦ Q J 7 6 2	♦ 4
♣ 5	♣ A K 8	♣ J 4 3

N	
W	E
S	

♠ A 6
♥ 9 4 2
♦ K 10
♣ Q 10 9 7 6 2

EW 4♠; N 5♣; S 4♣; NS 2N; NS 2♥; NS 2♦; Par +200; EW 5♠×-1

West	North	East	South
<i>bitran</i>	<i>ronpa</i>	<i>Rashid_K</i>	<i>jec</i>
		Pass	Pass
3 ♠	Dbl	5 ♠	6 ♣
Dbl	Pass	Pass	Pass

6 ♣× by South

<i>Trick</i>	<i>Lead</i>	<i>2nd</i>	<i>3rd</i>	<i>4th</i>
1. W	♠ K	8	9	<u>A</u>
2. S	♣ 2	5	<u>K</u>	4
3. N	♣ 8	3	<u>Q</u>	♠ 2
4. S	♦ K	<u>A</u>	2	4
5. W	♥ 8	<u>A</u>	5	2
6. N	♦ 6	<u>♣ J</u>	10	3
7. E	<u>♥ K</u>	4	7	3
8. E	♥ J	-	-	-

Down 2 — NS -500

**Board 521**  
 East Deals  
 E-W Vul

♠ 8 3 2 ♥ 8 ♦ A K 9 6 2 ♣ K 9 7 6		♠ J 10 7 6 4 ♥ 5 4 ♦ Q J 10 4 3 ♣ J	♠ K 9 ♥ A Q J 10 6 2 ♦ 8 5 ♣ 8 5 3
♠ A Q 5 ♥ K 9 7 3 ♦ 7 ♣ A Q 10 4 2			

NS 3♠; NS 1N; NS 2♦; EW 1♥; S 1♣; Par +140

West	North	East	South
<i>zfgst111</i>	<i>BridgeGoth</i>	<i>qingjiao</i>	<i>jec</i>
		1♥	2♣
2♦	Pass	2♥	Pass
Pass	Pass		

2♥ by East

Trick	Lead	2nd	3rd	4th
1. S	♦ 7	<u>A</u>	3	8
2. W	♥ 8	4	<u>A</u>	3
3. E	<u>♥ 10</u>	7	♠ 2	5
4. E	♥ J	<u>K</u>	♣ 6	♠ 4
5. S	♥ 9	♠ 3	♦ 4	<u>Q</u>
6. E	♦ 5	♣ 4	<u>K</u>	10
7. W	♦ 2	J	<u>♥ 2</u>	♣ 2
8. E	♣ 5	10	<u>K</u>	J
9. W	♣ 7	♠ 6	3	<u>A</u>
10. S	<u>♣ Q</u>	9	♦ Q	8
11. S	♠ 5	8	10	<u>K</u>
12. E	♠ 9	<u>Q</u>	♦ 6	7
13. S	♠ A	♦ 9	J	<u>♥ 6</u>

Made 3 — NS -140

**Board 530**  
 South Deals  
 N-S Vul

♠ K 9 5	♠ Q 8 7	♠ A
♥ Q 2	♥ A 4 3	♥ 9 6 5
♦ Q 5 2	♦ J 10 7 4	♦ A K 9 8 6 3
♣ A J 10 6 3	♣ K Q 5	♣ 8 7 4

♠ J 10 6 4 3 2
♥ K J 10 8 7
♦ —
♣ 9 2

NS 4♠; EW 2N; NS 2♥; EW 3♦; EW 2♣; Par +300; EW 4N×-2;  
 EW 5♦×-2

West	North	East	South
<i>zfgst111</i>	<i>BridgeGoth</i>	<i>qingjiao</i>	<i>jec</i>
			Pass
1 ♦	Pass	2 ♦	2 ♥
3 ♣	3 ♥	5 ♦	5 ♥
Dbl	Pass	Pass	Pass

5 ♥× by South

<i>Trick</i>	<i>Lead</i>	<i>2nd</i>	<i>3rd</i>	<i>4th</i>
1. W	♦ 2	4	K	<u>♥ 7</u>
2. S	♠ 2	5	Q	<u>A</u>
3. E	♣ 8	2	<u>A</u>	5
4. W	<u>♠ K</u>	7	♣ 4	4
5. W	♠ 9	8	<u>♥ 5</u>	3
6. E	♦ 3	<u>♥ 8</u>	5	7
7. S	<u>♥ K</u>	2	3	6
8. S	♥ 10	Q	<u>A</u>	9
9. N	♥ 4	♦ 6	<u>J</u>	♣ 3

Down 2 — NS -500

**Board 533**  
 East Deals  
 N-S Vul

♠ K Q 10 8 6 3 2	<div style="display: inline-block; background-color: green; color: white; padding: 5px; border: 1px solid black;">           N W     E S         </div>	♠ 5
♥ 9 2		♥ J 7 6 5 4 3
♦ Q 5		♦ K 7
♣ 9 2		♣ A K Q 7
	♠ J 4	
	♥ A K 10 8	
	♦ 8 3	
	♣ J 10 6 5 4	

EW 2♠; NS 3♦; NS 1N; EW 1♥; NS 1♣; Par +100; EW 3♠×-1

West	North	East	South
<i>zfgst111</i>	<i>BridgeGoth</i>	<i>qingjiao</i>	<i>jec</i>
		1♥	Pass
1♠	2♦	2♥	Pass
2♠	Pass	Pass	Pass

2♠ by West

<i>Trick</i>	<i>Lead</i>	<i>2nd</i>	<i>3rd</i>	<i>4th</i>
1. N	♥ Q	3	8	2
2. N	♦ A	7	8	5
3. N	♦ J	<u>K</u>	3	Q
4. E	♣ A	4	9	8
5. E	♣ K	5	2	3
6. E	♣ Q	6	♥ 9	<u>♠ 7</u>
7. N	♦ 10	♥ 4	♠ J	<u>♠ K</u>
8. W	♠ Q	<u>A</u>	5	4
9. N	♦ 9	-	-	-

Made 3 — NS -140

**Board 537**  
 East Deals  
 E-W Vul

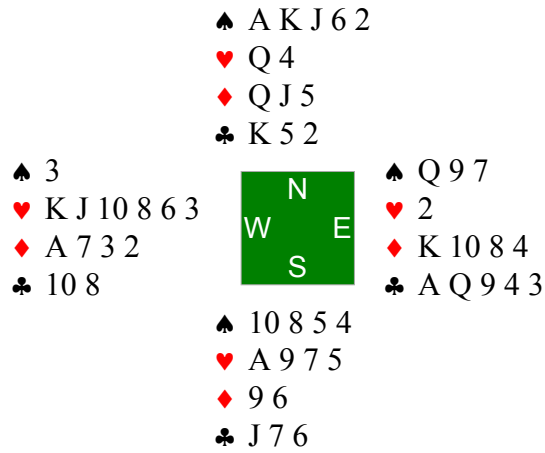

EW 3♥; EW 4♦; W 3♣; EW 1N; E 2♣; N 1♠; Par -140

West	North	East	South
<i>zfgst111</i>	<i>BridgeGoth</i>	<i>qingjiao</i>	<i>jec</i>
		1♦	Pass
1♥	1♠	2♣	3♠
Pass	Pass	Pass	

3♠ by North

<i>Trick</i>	<i>Lead</i>	<i>2nd</i>	<i>3rd</i>	<i>4th</i>
1. E	♥ 2	5	<u>K</u>	4
2. W	♥ J	Q	<u>♠ 7</u>	7
3. E	♦ 8	6	<u>A</u>	5
4. W	♥ 8	<u>♠ K</u>	♣ 4	9
5. N	<u>♠ A</u>	9	4	3
6. N	♠ 2	<u>Q</u>	5	♥ 6
7. E	<u>♦ K</u>	9	2	J
8. E	<u>♣ A</u>	6	10	2

Down 2 — NS -100

**Board 539**  
 West Deals  
 None Vul

♠ 7		♠ K 9 8 6 2
♥ A 6		♥ 10 8 7
♦ A Q 10 6 3		♦ 2
♣ A J 10 9 7		♣ K Q 8 2
♠ A J 5 4		♠ Q 10 3
♥ 5 2	♥ K Q J 9 4 3	♦ K 5
♦ J 9 8 7 4	♣ 4 3	
♣ 6 5		

EW 5♣; EW 1N; EW 2♦; EW 1♠; NS 1♥; Par -400

West	North	East	South
<i>zfgst111</i>	<i>BridgeGoth</i>	<i>qingjiao</i>	<i>jec</i>
1 ♦	2 ♥	2 ♠	Pass
3 ♣	Pass	Pass	Pass

3 ♣ by West

<i>Trick</i>	<i>Lead</i>	<i>2nd</i>	<i>3rd</i>	<i>4th</i>
1. N	♥ K	7	5	<u>A</u>
2. W	♠ 7	3	2	<u>J</u>
3. S	♥ 2	6	<u>J</u>	8
4. N	♥ Q	10	♦ 4	<u>♣ 7</u>
5. W	♦ A	5	2	8
6. W	♦ 3	K	<u>♣ 2</u>	7
7. E	♣ 8	5	<u>9</u>	3
8. W	♦ 6	♣ 4	<u>♣ Q</u>	9
9. E	♠ 6	4	<u>♣ 10</u>	10
10. W	♦ 10	♥ 3	<u>♣ K</u>	J
11. E	♠ 8	5	<u>♣ J</u>	Q
12. W	<u>♣ A</u>	♥ 4	♠ 9	6
13. W	♦ Q	♥ 9	♠ K	♠ A

Made 5 — NS -150

**Board 547**  
 West Deals  
 Both Vul

♠ 6 4 3 ♥ K 9 7 5 3 ♦ 8 ♣ K Q 7 4	♠ A 10 9 8 7 2 ♥ 6 ♦ J 9 ♣ 10 8 5 3	<div style="border: 1px solid black; background-color: green; width: 40px; height: 40px; margin: 0 auto; display: flex; flex-direction: column; align-items: center; justify-content: center;"> <div style="margin-bottom: 5px;">N</div> <div style="margin-bottom: 5px;">W</div> <div style="margin-bottom: 5px;">E</div> <div style="margin-bottom: 5px;">S</div> </div>	♠ K 5 ♥ A Q 4 ♦ A 10 7 6 4 3 ♣ 6 2
♠ Q J ♥ J 10 8 2 ♦ K Q 5 2 ♣ A J 9			

EW 3♥; EW 1N; EW 2♦; NS 1♠; S 1♣; Par -140

West	North	East	South
<i>woozle</i>	<i>smispi</i>	<i>stewball</i>	<i>jec</i>
Pass	Pass	1♦	1NT
Dbl	Rdbl <sup>1</sup>	Pass	2♣ <sup>2</sup>
Dbl	2♠	Pass	Pass
Pass			

1. forces 2C

2. forced

2♠ by North

<i>Trick</i>	<i>Lead</i>	<i>2nd</i>	<i>3rd</i>	<i>4th</i>
1. E	♣ 6	J	Q	3
2. W	♦ 8	9	<u>A</u>	2
3. E	♣ 2	<u>A</u>	4	5
4. S	♠ J	4	2	<u>K</u>
5. E	♦ 10	5	<u>♠ 3</u>	J
6. W	♥ 5	6	<u>Q</u>	2
7. E	♥ A	8	3	<u>♠ 7</u>
8. N	♠ 8	5	<u>Q</u>	6
9. S	<u>♦ Q</u>	♥ 7	♣ 8	3

Made 2 — NS +110



**Board 552**  
 North Deals  
 E-W Vul

♠ 10 9 8 3 ♥ 8 4 ♦ A 6 2 ♣ 10 8 4 2		♠ K 7 6 4 2 ♥ 7 6 ♦ K Q 4 ♣ J 9 5	♠ A 5 ♥ J 10 9 5 3 ♦ J 10 3 ♣ A Q 6
		♠ Q J ♥ A K Q 2 ♦ 9 8 7 5 ♣ K 7 3	

NS 3♠; NS 2N; NS 2♥; NS 2♦; NS 2♣; Par +140

West	North	East	South
<i>woozle</i>	<i>smispi</i>	<i>stewball</i>	<i>jec</i>
	Pass	1♥	Pass
Pass	1♠	Pass	Pass

Pass

1♠ by North

<i>Trick</i>	<i>Lead</i>	<i>2nd</i>	<i>3rd</i>	<i>4th</i>
1. E	♥ J	<u>A</u>	8	7
2. S	♦ 5	2	<u>K</u>	3
3. N	♠ 2	5	<u>J</u>	3
4. S	♠ Q	8	4	<u>A</u>
5. E	♥ 9	<u>Q</u>	4	6
6. S	♦ 7	6	<u>Q</u>	10
7. N	♠ <u>K</u>	♥ 3	♣ 3	9
8. N	♦ 4	J	8	<u>A</u>
9. W	♣ 8	5	<u>A</u>	7
10. E	♣ 6	-	-	-

Made 3 — NS +140

**Board 561**  
 East Deals  
 N-S Vul

♠ 9 ♥ A J 6 4 3 2 ♦ 9 8 6 3 ♣ Q 7		♠ K J 10 8 6 2 ♥ Q 9 8 ♦ K Q 10 ♣ 2	♠ A Q 3 ♥ 10 7 ♦ A 7 5 2 ♣ J 8 4 3
♠ 7 5 4 ♥ K 5 ♦ J 4 ♣ A K 10 9 6 5			

NS 3♠; EW 2♥; NS 1N; EW 2♦; NS 1♣; Par +140

West	North	East	South
<i>woozle</i>	<i>smispi</i>	<i>stewball</i>	<i>jec</i>
		Pass	Pass
3♥	3♠	Pass	4♠
Pass	Pass	Pass	

4♠ by North

<i>Trick</i>	<i>Lead</i>	<i>2nd</i>	<i>3rd</i>	<i>4th</i>
1. E	♥ 10	K	<u>A</u>	8
2. W	♦ 8	Q	<u>A</u>	4
3. E	♦ 2	<u>J</u>	3	10
4. S	♠ 4	9	10	<u>Q</u>
5. E	♥ 7	5	2	<u>9</u>
6. N	♠ 8	A	-	-

Down 1 — NS -100

**Board 565**  
 East Deals  
 N-S Vul

♠ J		♠ K 6 5
♥ Q 9 6 5 3		♥ J 8 4 2
♦ 10 9 7 6 3		♦ K
♣ 8 4		♣ A K Q 5 3
♠ 10 7 4 3		♥ A 10
♥ K 7	♦ A Q 8 2	♣ J 10 6
♦ J 5 4		
♣ 9 7 2		

NS 3♠; EW 3♥; NS 1N; EW 2♣; NS 1♦; Par +100; EW 4♥×-1

West	North	East	South
<i>scoolik</i>	<i>smispi</i>	<i>stewball</i>	<i>jec</i>
		1 ♣	Pass
1 ♥	1 ♠	3 ♥	4 ♠
5 ♥	Pass	Pass	Dbl
Pass	Pass	Pass	

5 ♥× by West

Trick	Lead	2nd	3rd	4th
1. N	<u>♠ A</u>	5	10	J
2. N	♦ 4	K	<u>A</u>	6
3. S	♣ 10	4	2	<u>A</u>
4. E	♠ 6	3	<u>♥ 3</u>	8
5. W	♥ 5	7	J	<u>A</u>
6. S	♣ J	8	7	<u>K</u>
7. E	♥ 2	10	Q	<u>K</u>

Down 2 — NS +300

**Board 573**  
 East Deals  
 Both Vul

	♠ Q J 7 2		
	♥ A J 10 8		
	♦ K J 6 3		
	♣ Q		
♠ 10 8 6 3	<div style="display: inline-block; background-color: green; color: white; padding: 5px; text-align: center;">       N        W     E        S     </div>	♠ K 5 4	
♥ 9 3		♥ K 7 6 5 2	
♦ A 10 9		♦ Q 7 5 4	
♣ A K 7 3		♣ J	
	♠ A 9		
	♥ Q 4		
	♦ 8 2		
	♣ 10 9 8 6 5 4 2		

NS 3♣; EW 1♠; N 1♥; EW 1♦; Par +110

West	North	East	South
<i>scoolik</i>	<i>smispi</i>	<i>stewball</i>	<i>jec</i>
		Pass	Pass
1♣	Dbl	1♥	Pass
Pass	Pass		

1♥ by East

Trick	Lead	2nd	3rd	4th
1. S	♠ <u>A</u>	3	7	4
2. S	♠ 9	10	J	<u>K</u>
3. E	♣ J	2	<u>A</u>	Q
4. W	♥ 3	<u>A</u>	2	4
5. N	♠ <u>Q</u>	5	♣ 10	6
6. N	♠ 2	♦ 4	♥ <u>Q</u>	8
7. S	♦ 8	9	<u>K</u>	5
8. N	♦ 3	7	2	<u>10</u>
9. W	♥ 9	10	<u>K</u>	♣ 9

Down 1 — NS +100

**Board 577**  
 East Deals  
 N-S Vul

♠ A	♠ K J 8 5 2	♠ Q 10 9 7 6
♥ A 10	♥ Q 4	♥ K 9 8 6
♦ 10 9 8 6	♦ A K	♦ 3 2
♣ K Q 10 7 4 2	♣ A 8 6 3	♣ J 5
	♠ 4 3	
	♥ J 7 5 3 2	
	♦ Q J 7 5 4	
	♣ 9	

EW 2N; NS 2♥; EW 2♣; NS 1♦; Par -120

West	North	East	South
<i>ghionis</i>	<i>llorenzo</i>	<i>alati</i>	<i>jec</i>
		Pass	Pass
1 ♣	1 ♠	Pass	Pass
2 ♣	Dbl	Pass	2 ♥
Pass	Pass	Pass	

2 ♥ by South

Trick	Lead	2nd	3rd	4th
1. W	♦ 9	<u>K</u>	2	4
2. N	♦ <u>A</u>	3	5	6
3. N	♣ <u>A</u>	5	9	2
4. N	♣ 3	J	♥ <u>2</u>	4
5. S	♠ 3	<u>A</u>	2	9
6. W	♥ <u>A</u>	4	6	3
7. W	♥ 10	Q	<u>K</u>	5
8. E	♥ 9	<u>J</u>	♣ 7	♣ 6
9. S	♦ <u>Q</u>	8	♠ 5	♠ 6
10. S	♦ <u>J</u>	10	♣ 8	♠ 7
11. S	♦ <u>7</u>	♣ 10	♠ 8	♠ 10
12. S	♠ 4	♣ Q	<u>K</u>	Q
13. N	♠ J	♥ <u>8</u>	♥ 7	♣ K

Made 3 — NS +140

**Board 586**  
 South Deals  
 None Vul

♠ K 9 7 4 3 2		♠ J
♥ 4		♥ A J 8 6
♦ 10		♦ A Q 8 7
♣ A Q 8 5 2		♣ K J 10 4
♠ Q 10 8 6	<div style="display: inline-block; border: 1px solid black; background-color: #006400; color: white; padding: 5px; margin: 0;">           N            W     E            S         </div>	♠ A 5
♥ Q 9 7 5 3 2		♥ K 10
♦ J 4		♦ K 9 6 5 3 2
♣ 3		♣ 9 7 6

EW 3♥; EW 2N; NS 2♣; NS 1♠; NS 1♦; Par -140

West	North	East	South
<i>ghionis</i>	<i>llorenzo</i>	<i>alati</i>	<i>jec</i>
			Pass
2♥ <sup>1</sup>	2♠	3♠	Dbl
4♥	4♠	5♥	Pass
Pass	Pass		

1. w  
 5♥ by West

Trick	Lead	2nd	3rd	4th
1. N	♦ 10	7	<u>K</u>	4
2. S	♦ 9	J	<u>♥ 4</u>	8
3. N	<u>♣ A</u>	4	6	3
4. N	♠ 3	J	<u>A</u>	6
5. S	♦ 6	<u>♥ Q</u>	♣ 2	Q
6. W	♥ 2	♠ 2	<u>A</u>	10
7. E	<u>♣ K</u>	9	♠ 8	5
8. E	♣ 10	7	<u>♥ 3</u>	8
9. W	♠ 10	7	<u>♥ 6</u>	5
10. E	♣ J	♦ 2	<u>♥ 5</u>	Q
11. W	♠ Q	K	♥ 8	<u>♥ K</u>
12. S	♦ 3	<u>♥ 7</u>	♠ 4	A
13. W	♥ 9	♠ 9	<u>J</u>	♦ 5

Down 3 — NS +150

**Board 587**  
 West Deals  
 N-S Vul

♠ A Q 8 6	<div style="display: inline-block; background-color: #006400; color: white; padding: 10px; border: 1px solid black;">           N W     E S         </div>	♠ K 9 5 4 2
♥ —		♥ 3
♦ A 10 9 3 2		♦ 8 5
♣ K 9 8 7		♣ A Q 6 4 2

♠ 10  
 ♥ A K Q J 10 7 5 4  
 ♦ 7 4  
 ♣ J 10

EW 6♠; EW 6♣; NS 3♥; EW 4♦; Par -980

West	North	East	South
<i>ghionis</i>	<i>llorenzo</i>	<i>alati</i>	<i>jec</i>
1 ♦	Pass	1 ♠	4 ♥
4 ♠	5 ♥	5 ♠	Pass
Pass	Pass		

5 ♠ by East

<i>Trick</i>	<i>Lead</i>	<i>2nd</i>	<i>3rd</i>	<i>4th</i>
1. S	♥ A	♠ 6	9	3
2. W	♠ A	3	2	10
3. W	♠ Q	7	4	♥ 7
4. W	♠ 8	J	♠ K	♥ 4
5. E	♣ 2	10	♠ K	3
6. W	♣ 7	5	-	-

Made 6 — NS -480

**Board 590**  
 South Deals  
 N-S Vul

♠ A K Q J 8		♠ 10 9 4 3 2
♥ A 6		♥ 5 4 3 2
♦ J 7 6		♦ A Q 5 3
♣ 8 7 2		♣ —

♠ 5  
 ♥ Q 10 8 7  
 ♦ K 4  
 ♣ A K Q 10 9 4

♠ 7 6  
 ♥ K J 9  
 ♦ 10 9 8 2  
 ♣ J 6 5 3

EW 6♠; EW 3♦; NS 3♣; EW 1N; Par -980

West	North	East	South
<i>ghionis</i>	<i>llorenzo</i>	<i>alati</i>	<i>jec</i>
			Pass
1 ♠	2 ♣	4 ♠	Pass
Pass	Dbl	Pass	5 ♣
Pass	Pass	5 ♠	Pass
Pass	Pass		

5 ♠ by West

<i>Trick</i>	<i>Lead</i>	<i>2nd</i>	<i>3rd</i>	<i>4th</i>
1. N	♣ A	♠ 2	6	2
2. E	♠ 3	6	A	5
3. W	♠ K	♣ 10	4	7
4. W	♦ 6	4	Q	2
5. E	♦ A	8	7	K
6. E	♦ 3	9	J	♣ 4

Made 6 — NS -480



**Board 595**  
 West Deals  
 Both Vul

♠ K 3	♠ Q 9 7	♠ J 10 2
♥ A J 9	♥ K 10 7 4 3 2	♥ Q 8
♦ K	♦ 8 4 3	♦ A Q J 10 9 7 6
♣ 10 9 8 5 4 3 2	♣ K	♣ 6
	<div style="display: inline-block; background-color: #006400; color: white; padding: 5px; text-align: center; border: 1px solid black;">           N            W     E            S         </div>	
	♠ A 8 6 5 4	
	♥ 6 5	
	♦ 5 2	
	♣ A Q J 7	

EW 2N; NS 2♠; EW 3♦; EW 2♣; NS 1♥; Par -120

West	North	East	South
<i>ghionis</i>	<i>llorenzo</i>	<i>alati</i>	<i>jec</i>
1 ♣	Pass	1 ♦	1 ♠
2 ♣	Dbl	3 ♦	Pass
Pass	3 ♠	Pass	Pass

Pass

3 ♠ by South

<i>Trick</i>	<i>Lead</i>	<i>2nd</i>	<i>3rd</i>	<i>4th</i>
1. W	♦ K	3	<u>A</u>	2
2. E	♣ 6	7	2	<u>K</u>
3. N	♠ 7	2	<u>A</u>	3
4. S	♠ 4	<u>K</u>	9	10
5. W	♣ 9	♥ 2	<u>♠ J</u>	J
6. E	<u>♦ Q</u>	5	♣ 3	4
7. E	♥ 8	5	<u>A</u>	3

Down 1 — NS -100

**Board 597**  
 East Deals  
 E-W Vul

♠ A 10 9 8 7 ♥ A K J 5 ♦ 3 ♣ 8 6 3		♠ K J 6 4 2 ♥ 2 ♦ 10 9 6 2 ♣ A Q J	♠ 5 3 ♥ Q 7 6 ♦ A Q 8 7 5 4 ♣ 10 5
♠ Q ♥ 10 9 8 4 3 ♦ K J ♣ K 9 7 4 2			

NS 2♣; NS 1♠; EW 1♥; EW 1♦; Par +90

West	North	East	South
<i>ghionis</i>	<i>llorenzo</i>	<i>alati</i>	<i>jec</i>
		2♦ <sup>1</sup>	Pass
Pass	2♠	Pass	Pass
Pass			

1. weak♦

2♠ by North

Trick	Lead	2nd	3rd	4th
1. E	♣ 10	2	6	<u>A</u>
2. N	♠ 2	3	Q	<u>A</u>
3. W	♣ 8	<u>Q</u>	5	4
4. N	<u>♠ K</u>	5	♥ 3	7
5. N	<u>♠ J</u>	♦ 5	♥ 4	8
6. N	♣ J	♦ 7	<u>K</u>	3
7. S	♣ 9	<u>♠ 9</u>	♥ 2	♦ 4
8. W	<u>♠ 10</u>	4	♦ 8	♥ 8
9. W	♥ A	♦ 2	6	9
10. W	♥ K	♦ 6	Q	10
11. W	♥ J	<u>♠ 6</u>	7	♣ 7
12. N	♦ 9	<u>A</u>	J	3
13. E	♦ Q	<u>K</u>	♥ 5	10

Down 1 — NS -50

**Board 601**  
 East Deals  
 Both Vul

♠ Q 10 9 5	♠ A 8 3	♠ J 7 4 2
♥ 5 2	♥ 10 8 7 6	♥ A K Q J 9
♦ —	♦ Q J 8 5	♦ A K 10
♣ K 10 9 8 4 3 2	♣ A Q	♣ 7

♠ K 6	♠ K 6	♠ J 7 4 2
♥ 4 3	♥ 4 3	♥ A K Q J 9
♦ 9 7 6 4 3 2	♦ 9 7 6 4 3 2	♦ A K 10
♣ J 6 5	♣ J 6 5	♣ 7

EW 4♠; EW 3N; EW 3♥; NS 2♦; EW 2♣; Par -620

West	North	East	South
<i>ghionis</i>	<i>llorenzo</i>	<i>alati</i>	<i>jec</i>
		1 ♥	Pass
Pass	1 NT	Pass	Pass
2 ♣	Pass	2 ♥	Pass
Pass	Pass		

2 ♥ by East

Trick	Lead	2nd	3rd	4th
1. S	♠ K	5	3	2
2. S	♠ 6	9	<u>A</u>	4
3. N	♠ 8	J	<u>♥ 3</u>	10
4. S	♣ 5	K	<u>A</u>	7
5. N	♥ 6	J	4	2
6. E	♦ 10	2	<u>♥ 5</u>	5
7. W	♣ 2	Q	<u>♥ 9</u>	6
8. E	♥ A	♦ 3	-	-

Made 3 — NS -140

**Board 603**  
 West Deals  
 N-S Vul

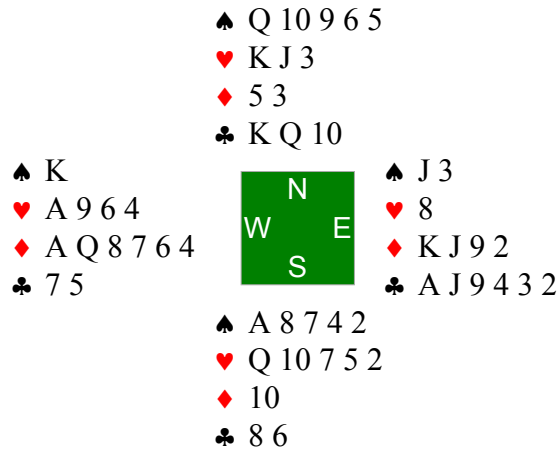

EW 5♦; NS 3♥; EW 4♣; EW 2N; NS 2♠; Par -400

West	North	East	South
<i>ghionis</i>	<i>llorenzo</i>	<i>alati</i>	<i>jec</i>
1 ♦	1 ♠	2 ♣	4 ♠
Pass	Pass	5 ♦	Pass
Pass	Pass		

5 ♦ by West

<i>Trick</i>	<i>Lead</i>	<i>2nd</i>	<i>3rd</i>	<i>4th</i>
1. N	♠ 10	3	<u>A</u>	K
2. S	♥ 7	<u>A</u>	3	8
3. W	♦ 4	3	<u>J</u>	10
4. E	♦ 2	♠ 4	<u>A</u>	5
5. W	♣ 5	K	<u>A</u>	8
6. E	♠ J	2	<u>♦ 6</u>	9
7. W	♣ 7	<u>Q</u>	2	6
8. N	♥ K	-	-	-

Made 5 — NS -400

**Board 605**  
 East Deals  
 N-S Vul

♠ A K Q 2	♠ J	♠ 10 9 7 6
♥ 9 8 6 4	♥ 10	♥ J 7 3
♦ Q 6 2	♦ K J 10 5 4	♦ A 8 3
♣ 7 6	♣ A K 10 9 8 4	♣ J 5 3

♠ 8 5 4 3
♥ A K Q 5 2
♦ 9 7
♣ Q 2

NS 5♦; NS 5♣; NS 2N; NS 2♥; NS 1♠; Par +600

West	North	East	South
<i>bid better</i>	<i>BridgeGoth</i>	<i>lastrose</i>	<i>jec</i>
		Pass	Pass
1 ♠	2 NT	3 ♠	Dbl
Pass	Pass	Pass	

3 ♠× by West

<i>Trick</i>	<i>Lead</i>	<i>2nd</i>	<i>3rd</i>	<i>4th</i>
1. N	♥ 10	J	Q	4
2. S	♥ <u>K</u>	6	♦ 5	3
3. S	♥ <u>A</u>	8	♣ 4	7
4. S	♥ 5	9	♠ <u>J</u>	♦ 3
5. N	♣ <u>A</u>	3	2	6
6. N	♣ 8	5	Q	7
7. S	♦ 9	Q	K	<u>A</u>
8. E	♠ 6	3	<u>K</u>	♣ 9
9. W	♦ 2	<u>10</u>	8	7

Down 3 — NS +500

**Board 606**  
 South Deals  
 E-W Vul

♠ —	♠ A Q 7 6 4 3 2	♠ K 10
♥ K J 10 7 5	♥ Q 8 4	♥ A 3
♦ A 9	♦ K J 8	♦ 10 4 3 2
♣ A K 10 7 6 2	♣ —	♣ Q J 9 4 3

W	N	E
	S	

♠ J 9 8 5
♥ 9 6 2
♦ Q 7 6 5
♣ 8 5

EW 7♣; EW 6N; W 6♥; E 5♥; NS 2♠; W 2♦; E 1♦; Par -1100:  
 NS 7♠×-5

West	North	East	South
<i>bid better</i>	<i>BridgeGoth</i>	<i>lastrose</i>	<i>jec</i>
			Pass
1 ♥	1 ♠	Dbl	3 ♠
4 ♣	4 ♠	5 ♣	Pass
Pass	Pass		

5 ♣ by West

<i>Trick</i>	<i>Lead</i>	<i>2nd</i>	<i>3rd</i>	<i>4th</i>
1. N	♠ A	10	8	<u>♣ 7</u>
2. W	♣ K	♠ 2	3	5
3. W	♣ 2	♠ 3	<u>Q</u>	8
4. E	♠ K	5	♦ 9	4
5. E	♥ A	2	5	4
6. E	♥ 3	9	<u>K</u>	8
7. W	♥ J	Q	<u>♣ 4</u>	6

Made 7 — NS -640

**Board 607**  
 West Deals  
 Both Vul

♠ A K 9 6 5 3	♠ J	♠ 8 7 4 2
♥ K 8 2	♥ J 9	♥ 10 7 6
♦ A	♦ K Q J 10 8	♦ 9 4 2
♣ Q 7 6	♣ A 10 5 4 2	♣ K J 8

♠ Q 10	♠ Q 10	♠ Q 10
♥ A Q 5 4 3	♥ A Q 5 4 3	♥ A Q 5 4 3
♦ 7 6 5 3	♦ 7 6 5 3	♦ 7 6 5 3
♣ 9 3	♣ 9 3	♣ 9 3

EW 4♠; NS 2♥; NS 3♦; EW 1N; NS 1♣; Par -500: NS 5♦×-2

West	North	East	South
<i>bid better</i>	<i>BridgeGoth</i>	<i>lastrose</i>	<i>jec</i>
1 ♠	2 NT	Pass	3 ♦
3 ♠	Pass	Pass	4 ♦
Pass	Pass	Pass	

4 ♦ by South

<i>Trick</i>	<i>Lead</i>	<i>2nd</i>	<i>3rd</i>	<i>4th</i>
1. W	♠ <u>K</u>	J	7	Q
2. W	♦ <u>A</u>	8	2	3
3. W	♥ 2	9	10	<u>Q</u>
4. S	♣ 3	7	10	<u>J</u>
5. E	♥ 7	<u>A</u>	8	J
6. S	♣ 9	6	<u>A</u>	8
7. N	♦ <u>K</u>	4	5	♠ 3
8. N	♣ 2	K	<u>♦ 6</u>	Q

Made 4 — NS +130

**Board 609**  
 East Deals  
 E-W Vul

♠ J 9 6 ♥ J 10 5 3 ♦ A 7 ♣ K Q 5 3	♠ A 3 2 ♥ K 9 8 2 ♦ Q 9 4 ♣ A 10 2	<div style="text-align: center; border: 1px solid black; width: 40px; height: 40px; margin: 0 auto; background-color: #006400; color: white; display: flex; flex-direction: column; align-items: center; justify-content: center;"> <span>N</span> <span>W</span> <span>E</span> <span>S</span> </div>	♠ K 10 ♥ Q 6 4 ♦ J 8 6 3 2 ♣ 9 8 4
	♠ Q 8 7 5 4 ♥ A 7 ♦ K 10 5 ♣ J 7 6		

NS 3N; NS 3♠; NS 2♦; NS 2♣; NS 1♥; Par +400

West	North	East	South
<i>bid better</i>	<i>BridgeGoth</i>	<i>lastrose</i>	<i>jec</i>
		Pass	Pass
1 ♣	Dbl	Pass	2 ♠
Pass	Pass	Pass	

2 ♠ by South

<i>Trick</i>	<i>Lead</i>	<i>2nd</i>	<i>3rd</i>	<i>4th</i>
1. W	♣ K	<u>A</u>	8	6
2. N	♠ <u>A</u>	10	4	6
3. N	♠ 2	<u>K</u>	5	9
4. E	♣ 9	7	<u>Q</u>	2
5. W	♣ 3	10	4	<u>J</u>
6. S	♠ <u>Q</u>	J	3	♦ 2
7. S	♦ K	<u>A</u>	4	3
8. W	♦ 7	9	<u>J</u>	5

Made 3 — NS +140



**Board 612**  
 North Deals  
 E-W Vul

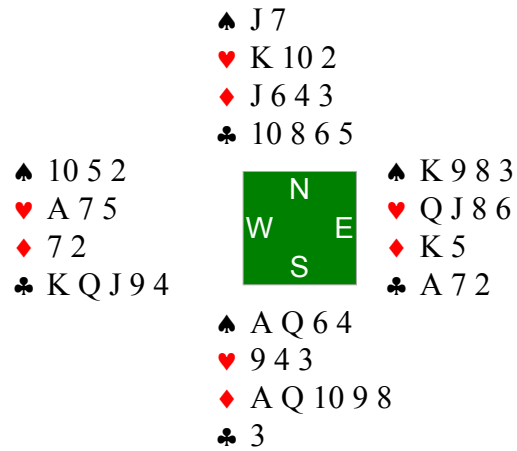

NS 4♦; NS 1N; E 2♣; E 1♠; E 1♥; W 1♣; Par +130

West	North	East	South
<i>bid better</i>	<i>BridgeGoth</i>	<i>lastrose</i>	<i>jec</i>
	Pass	1 ♣	1 ♦
2 ♦ <sup>1</sup>	3 ♦	Pass	3 ♠
Pass	4 ♦	Pass	Pass
Pass			

1. limit raise or better to Club

4 ♦ by South

Trick	Lead	2nd	3rd	4th
1. W	♣ <u>K</u>	5	2	3
2. W	♣ 4	6	<u>A</u>	♥ 3
3. E	♣ 7	♦ <u>8</u>	9	8
4. S	♥ 4	<u>A</u>	2	6
5. W	♣ Q	10	♥ Q	♦ <u>9</u>
6. S	♥ 9	5	<u>K</u>	8
7. N	♠ J	K	<u>A</u>	5
8. S	♠ <u>Q</u>	2	7	3
9. S	♠ 4	10	♦ <u>6</u>	8
10. N	♦ <u>J</u>	5	10	2
11. N	♦ 3	K	<u>A</u>	7
12. S	♠ 6	♥ 7	♦ 4	9
13. N	♥ 10	J	♦ <u>Q</u>	♣ J

Made 4 — NS +130

**Board 613**  
 East Deals  
 Both Vul

♠ 6 5 3 2 ♥ Q 10 9 8 5 ♦ A K 4 ♣ K		♠ A Q 10 ♥ A K ♦ Q J 9 3 ♣ A Q 8 3	♠ K J 7 ♥ J 7 6 4 2 ♦ 8 6 ♣ 9 4 2
♠ 9 8 4 ♥ 3 ♦ 10 7 5 2 ♣ J 10 7 6 5			

EW 3♥; NS 2N; NS 3♦; NS 3♣; NS 1♠; Par -140

West	North	East	South
<i>bid better</i>	<i>BridgeGoth</i>	<i>lastrose</i>	<i>jec</i>
		Pass	Pass
1♥	Dbl	3♥	Pass
Pass	3NT	Pass	Pass

Pass

3 NT by North

<i>Trick</i>	<i>Lead</i>	<i>2nd</i>	<i>3rd</i>	<i>4th</i>
1. E	♥ 4	3	Q	<u>A</u>
2. N	♣ <u>A</u>	9	5	K
3. N	♣ <u>Q</u>	4	6	♠ 6
4. N	♣ 8	2	<u>J</u>	♠ 2
5. S	♠ 4	3	10	<u>J</u>
6. E	♥ 6	♦ 2	8	<u>K</u>
7. N	♣ 3	♦ 6	<u>10</u>	♦ 4
8. S	♣ <u>7</u>	♥ 5	♦ 3	♦ 8
9. S	♠ 8	5	Q	<u>K</u>
10. E	♥ 2	♠ 9	<u>9</u>	♦ 9
11. W	♦ <u>A</u>	J	♠ 7	5
12. W	♦ <u>K</u>	Q	♥ 7	7
13. W	♥ 10	♠ A	<u>J</u>	♦ 10

Down 2 — NS -200

**Board 617**  
 East Deals  
 None Vul

♠ A 10 5 2	♠ K J 4 3	♠ Q 9 8 6
♥ Q 8 2	♥ J 10 9 7	♥ 3
♦ Q 6	♦ A K	♦ 10 9 7 5 4
♣ A 8 5 2	♣ Q 7 3	♣ J 10 9

♠ 7
♥ A K 6 5 4
♦ J 8 3 2
♣ K 6 4

NS 4♥; NS 2N; NS 2♦; NS 2♣; W 1♠; Par +420

West	North	East	South
<i>bid better</i>	<i>BridgeGoth</i>	<i>lastrose</i>	<i>jec</i>
		Pass	Pass
1 ♣	Dbl	Pass	2 ♥
Pass	4 ♥	Pass	Pass

Pass

4 ♥ by South

<i>Trick</i>	<i>Lead</i>	<i>2nd</i>	<i>3rd</i>	<i>4th</i>
1. W	♦ Q	<u>K</u>	7	2
2. N	♥ 7	3	<u>K</u>	2
3. S	♠ 7	2	<u>K</u>	6
4. N	♠ 3	8	<u>♥ 4</u>	5
5. S	♦ 3	6	<u>A</u>	4
6. N	♠ 4	9	<u>♥ 5</u>	10
7. S	♣ 4	2	<u>Q</u>	10
8. N	♠ J	Q	<u>♥ 6</u>	A
9. S	<u>♥ A</u>	8	9	♦ 5
10. S	♦ J	<u>♥ Q</u>	♣ 3	9
11. W	<u>♣ A</u>	7	9	6
12. W	♣ 5	-	-	-

Made 5 — NS +450

**Board 621**  
 East Deals  
 N-S Vul

♠ 10 7	♠ 8 2	♠ Q 9 3
♥ 9 8 6 2	♥ A Q 7 4	♥ J 10 3
♦ J 9 4	♦ Q 6 5 3 2	♦ A K 10 8
♣ 9 8 4 3	♣ J 2	♣ K 7 6

♠ A K J 6 5 4
♥ K 5
♦ 7
♣ A Q 10 5

NS 6♠; N 5N; S 3N; N 5♣; NS 3♥; S 4♣; NS 3♦; Par +1430

West	North	East	South
<i>bid better</i>	<i>BridgeGoth</i>	<i>lastrose</i>	<i>jec</i>
		1♦	Dbl
Pass	2♥	Pass	2♠
Pass	3NT	Pass	4♣
Pass	4♠	Pass	Pass

Pass

4♠ by South

<i>Trick</i>	<i>Lead</i>	<i>2nd</i>	<i>3rd</i>	<i>4th</i>
1. W	♦ 4	2	<u>K</u>	7
2. E	♠ 3	<u>J</u>	7	2
3. S	<u>♠ A</u>	10	8	9
4. S	<u>♠ K</u>	♥ 2	♦ 3	Q
5. S	<u>♥ K</u>	6	4	J
6. S	♥ 5	8	<u>A</u>	3
7. N	<u>♥ Q</u>	10	♣ 5	9
8. N	♣ J	K	-	-

Made 6 — NS +680

**Board 624**  
 North Deals  
 N-S Vul

♠ 8 3 ♥ Q J 10 6 3 ♦ Q 10 7 6 4 ♣ 4		♠ J 10 9 ♥ A 9 ♦ 9 5 3 2 ♣ K Q 10 5	♠ A K Q 6 4 2 ♥ 8 5 2 ♦ A 8 ♣ 8 6
♠ 7 5 ♥ K 7 4 ♦ K J ♣ A J 9 7 3 2			

EW 3♥; NS 4♣; EW 1♠; EW 1♦; Par +100: EW 4♥×-1

West	North	East	South
<i>bid better</i>	<i>BridgeGoth</i>	<i>lastrose</i>	<i>jec</i>
	Pass	1 ♠	2 ♣
Pass	3 ♣	3 ♠	Pass
Pass	Pass		

3 ♠ by East

<i>Trick</i>	<i>Lead</i>	<i>2nd</i>	<i>3rd</i>	<i>4th</i>
1. S	♣ A	4	K	6
2. S	♣ 3	♠ 3	5	8
3. W	♠ 8	9	Q	5
4. E	♠ K	7	♦ 4	10
5. E	♠ A	♣ 2	♦ 6	J
6. E	♥ 5	4	10	A
7. N	♦ 2	8	K	7

Made 3 — NS -140

**Board 627**  
 West Deals  
 None Vul

♠ 9 6 4 3 ♥ A 9 6 ♦ A J 7 6 ♣ Q 4	♠ A K 8 2 ♥ 10 5 ♦ 2 ♣ A J 10 9 8 3		♠ 7 ♥ 8 3 2 ♦ K Q 8 5 4 ♣ K 6 5 2
♠ Q J 10 5 ♥ K Q J 7 4 ♦ 10 9 3 ♣ 7			

NS 4♠; NS 2♥; EW 2♦; NS 2♣; Par +420

West	North	East	South
<i>bid better</i>	<i>BridgeGoth</i>	<i>lastrose</i>	<i>jec</i>
1 ♦	2 ♣	2 ♦	Dbl
Pass	3 ♠	4 ♦	4 ♠
Pass	Pass	Dbl	Pass
Pass	Pass		

4 ♠× by North

<i>Trick</i>	<i>Lead</i>	<i>2nd</i>	<i>3rd</i>	<i>4th</i>
1. E	<u>♦ K</u>	3	6	2
2. E	♦ 4	9	A	<u>♠ 2</u>
3. N	<u>♥ 10</u>	3	4	6
4. N	♥ 5	2	K	<u>A</u>
5. W	♦ J	<u>♠ 8</u>	5	10
6. N	<u>♣ A</u>	2	7	4
7. N	♣ J	5	<u>♠ 5</u>	Q

Made 4 — NS +590

**Board 628**  
 North Deals  
 E-W Vul

♠ K 9 4 2	<div style="display: inline-block; background-color: #008000; color: white; padding: 10px; border: 1px solid black;">           N W     E S         </div>	♠ A J 6 5
♥ 3		♥ A Q J 7 6 4 2
♦ A K 6 4		♦ 3
♣ 10 8 7 2		♣ J
♠ Q		♥ K 9 8 5
	♦ Q 2	
	♣ A 9 6 5 4 3	

EW 4♥; EW 3♠; EW 1N; NS 1♣; Par -620

West	North	East	South
<i>bid better</i>	<i>BridgeGoth</i>	<i>lastrose</i>	<i>jec</i>
	Pass	1 ♥	2 ♣
Dbl	Pass	2 ♠	Pass
3 ♠	Pass	4 ♥	Pass
4 ♠	Pass	Pass	Pass

4 ♠ by East

<i>Trick</i>	<i>Lead</i>	<i>2nd</i>	<i>3rd</i>	<i>4th</i>
1. S	♣ A	2	K	J
2. S	♣ 3	7	Q	♠ 5
3. E	♥ A	5	3	10
4. E	♥ Q	8	♦ 4	♠ 3
5. N	♦ J	3	2	A
6. W	♣ 10	♠ 7	♠ J	4
7. E	♠ A	Q	2	8
8. E	♥ 7	9	♠ 4	♠ 10
9. N	♦ 10	♥ 2	Q	K
10. W	♦ 6	8	♠ 6	♣ 5

Down 1 — NS +100

**Board 631**  
 West Deals  
 N-S Vul

♠ 9 7		♠ A Q 4 3
♥ Q J 6 2		♥ 9 5 4
♦ A K 7		♦ 9 4
♣ K J 9 3		♣ A 10 8 5
♠ K 6 2		♠ J 10 8 5
♥ —		♥ A K 10 8 7 3
♦ Q J 6 5 3 2		♦ 10 8
♣ Q 6 4 2		♣ 7

EW 3N; W 3♠; EW 4♣; E 2♠; W 3♦; EW 1♥; E 1♦; Par -400

West	North	East	South
<i>bid better</i>	<i>BridgeGoth</i>	<i>lastrose</i>	<i>jec</i>
1 ♣	Pass	1 ♠	2 ♥
Pass	Pass	Dbl	Pass
Pass	3 ♦	Pass	Pass
Dbl	Pass	Pass	Pass

3 ♦× by North

<i>Trick</i>	<i>Lead</i>	<i>2nd</i>	<i>3rd</i>	<i>4th</i>
1. E	♥ 4	<u>A</u>	2	♣ 2
2. S	♥ <u>K</u>	6	♣ 4	5
3. S	♣ 7	<u>J</u>	6	5
4. W	♦ <u>K</u>	2	4	8
5. W	♦ <u>A</u>	3	9	10
6. W	♠ 9	2	<u>Q</u>	5
7. E	♠ <u>A</u>	8	7	K
8. E	♠ 3	10	♦ <u>7</u>	6
9. W	♣ 3	Q	<u>A</u>	♥ 3

Down 3 — NS -800



**Board 635**  
 West Deals  
 Both Vul

♠ 10 5 4		♠ Q 8 6
♥ 10 6 5 2		♥ A Q 8
♦ 5		♦ 7 6 4 2
♣ A 9 7 6 5		♣ J 10 3
♠ J 9 7	<div style="display: inline-block; background-color: green; color: white; padding: 5px; border: 1px solid black;">           N            W     E            S         </div>	♠ A K 3 2
♥ K J		♥ 9 7 4 3
♦ K Q J 10 9		♦ A 8 3
♣ Q 4 2		♣ K 8

NS 3♥; NS 2♠; EW 1N; NS 2♣; EW 1♦; Par +140

West	North	East	South
<i>Alamiro</i>	<i>smispi</i>	<i>EdoWell</i>	<i>jec</i>
1 ♦	Pass	1 NT	Dbl
Pass	2 ♣	Pass	Pass
2 ♦	2 ♥	Pass	Pass
Pass			

2♥ by North

<i>Trick</i>	<i>Lead</i>	<i>2nd</i>	<i>3rd</i>	<i>4th</i>
1. E	♦ 4	<u>A</u>	K	5
2. S	♦ 3	9	<u>♥ 2</u>	7
3. N	♣ 6	J	<u>K</u>	4
4. S	♦ 8	10	<u>♥ 5</u>	2
5. N	♥ 6	8	9	<u>J</u>
6. W	♥ K	10	<u>A</u>	3
7. E	<u>♥ Q</u>	4	♦ J	♣ 5
8. E	♦ 6	<u>♥ 7</u>	Q	♣ 7
9. S	♠ 2	9	10	<u>Q</u>
10. E	♣ 3	8	Q	<u>A</u>
11. N	♠ 5	6	<u>A</u>	7
12. S	<u>♠ K</u>	J	4	8
13. S	<u>♠ 3</u>	♣ 2	♣ 9	♣ 10

Made 3 — NS +140

**Board 637**  
 East Deals  
 E-W Vul

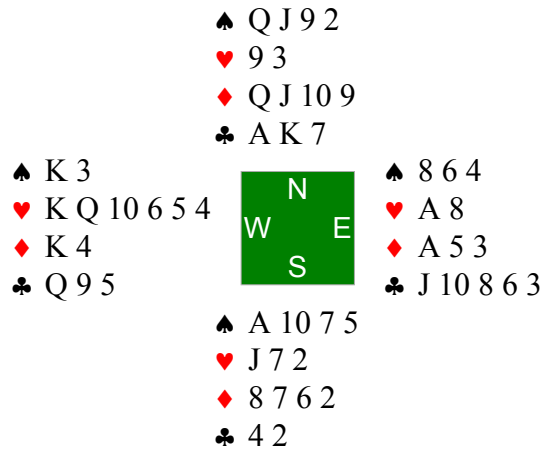

EW 3N; EW 3♥; EW 4♣; NS 2♠; NS 1♦; Par -300; NS 4♠×-2

West	North	East	South
<i>Alamiro</i>	<i>smispi</i>	<i>EdoWell</i>	<i>jec</i>
		Pass	Pass
1 ♥	Dbl	1 NT	2 ♠
Pass	Pass	3 ♣	Pass
Pass	3 ♠	Pass	Pass
4 ♣	Pass	Pass	Pass

4 ♣ by East

<i>Trick</i>	<i>Lead</i>	<i>2nd</i>	<i>3rd</i>	<i>4th</i>
1. S	♦ 6	<u>K</u>	Q	3
2. W	♣ Q	<u>K</u>	3	2
3. N	♦ J	<u>A</u>	2	4
4. E	♦ 5	7	<u>♣ 5</u>	9
5. W	♣ 9	<u>A</u>	6	4
6. N	♠ 2	6	<u>A</u>	3
7. S	♦ 8	♥ 4	10	<u>♣ 8</u>
8. E	♣ J	-	-	-

Made 4 — NS -130

**Board 641**  
 East Deals  
 Both Vul

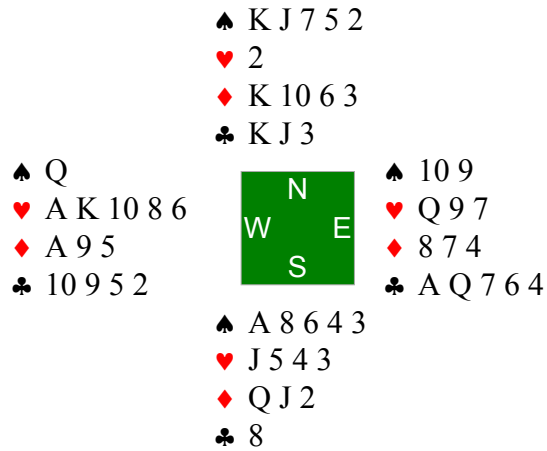

EW 6♣; EW 5♥; NS 4♠; EW 2N; NS 2♦; Par -500: NS 6♠×-2

West	North	East	South
<i>Alamiro</i>	<i>smispi</i>	<i>EdoWell</i>	<i>jec</i>
		Pass	Pass
1 ♥	1 ♠	2 ♥	4 ♠
Pass	Pass	Pass	

4 ♠ by North

<i>Trick</i>	<i>Lead</i>	<i>2nd</i>	<i>3rd</i>	<i>4th</i>
1. E	♠ 9	3	Q	<u>K</u>
2. N	♠ 2	10	<u>A</u>	♥ 8
3. S	♦ J	9	3	7
4. S	♦ Q	<u>A</u>	6	4
5. W	♥ <u>A</u>	2	7	3
6. W	♣ 5	K	<u>A</u>	8

Made 4 — NS +620

**Board 643**  
 West Deals  
 N-S Vul

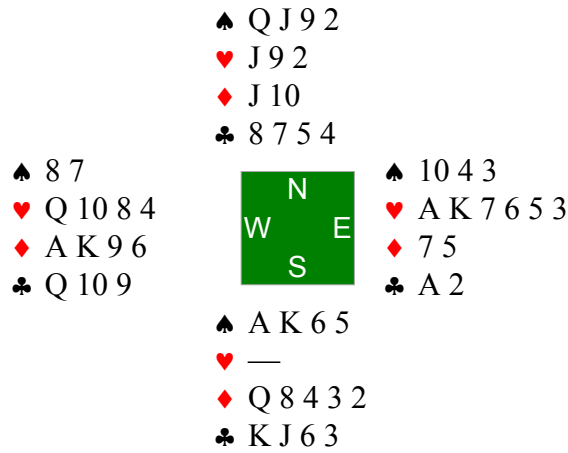

EW 4♥; EW 3N; NS 2♠; NS 2♣; EW 1♦; Par -420

West	North	East	South
<i>Alamiro</i>	<i>smispi</i>	<i>EdoWell</i>	<i>jec</i>
1 ♦	Pass	1 ♥	Dbl
2 ♥	Pass	4 ♥	Pass
Pass	Pass		

4 ♥ by East

<i>Trick</i>	<i>Lead</i>	<i>2nd</i>	<i>3rd</i>	<i>4th</i>
1. S	♠ <u>A</u>	7	Q	4
2. S	♠ 5	8	<u>J</u>	3
3. N	♣ 7	<u>A</u>	6	9
4. E	♥ 5	♦ 2	<u>Q</u>	2
5. W	♥ 4	9	<u>A</u>	♣ 3
6. E	♠ 10	6	♥ <u>8</u>	9
7. W	♥ 10	J	<u>K</u>	♦ 3
8. E	♥ <u>7</u>	♣ J	♦ 6	♠ 2
9. E	♥ <u>6</u>	♠ K	♣ 10	♣ 4
10. E	♥ <u>3</u>	♦ 4	♣ Q	♣ 5
11. E	♦ 5	-	-	-

Made 5 — NS -450

**Board 645**  
 East Deals  
 None Vul

♠ 8 7 6 5 2	♠ K Q 9 4	♠ 3
♥ J 9	♥ 10 8 5	♥ A 6 4
♦ A 7	♦ Q 10 6	♦ K J 9 8 5 3
♣ J 10 7 4	♣ A 6 3	♣ K 9 5
	<div style="display: inline-block; border: 1px solid black; background-color: #006400; color: white; padding: 5px; text-align: center; margin: 5px;">           N            W     E            S         </div>	
	♠ A J 10	
	♥ K Q 7 3 2	
	♦ 4 2	
	♣ Q 8 2	

NS 2♥; EW 1N; EW 2♦; E 2♣; NS 1♠; W 1♣; Par +100:  
 EW 2N×-1; E 3♣×-1; EW 3♦×-1

West	North	East	South
<i>Alamiro</i>	<i>smispi</i>	<i>EdoWell</i>	<i>jec</i>
		1 ♦	1 ♥
1 ♠	2 ♦	3 ♦	Pass
Pass	Pass		

3 ♦ by East

Trick	Lead	2nd	3rd	4th
1. S	♥ <u>K</u>	9	5	4
2. S	♦ 2	7	Q	<u>K</u>
3. E	♥ <u>A</u>	2	J	10
4. E	♥ 6	7	♦ <u>A</u>	8
5. W	♣ J	3	5	<u>Q</u>
6. S	♥ Q	♠ 2	♣ 6	♦ <u>3</u>
7. E	♦ <u>J</u>	4	♠ 5	6

Down 1 — NS +50

**Board 647**  
 West Deals  
 E-W Vul

♠ Q 9 7 3 ♥ A Q 4 2 ♦ K J 7 ♣ 8 3		♠ A 8 5 2 ♥ 7 ♦ Q 9 5 4 3 ♣ A 9 5	♠ 10 4 ♥ J 9 8 6 3 ♦ 10 8 2 ♣ 10 4 2
♠ K J 6 ♥ K 10 5 ♦ A 6 ♣ K Q J 7 6			

S 4N; NS 4♠; N 3N; NS 5♦; NS 5♣; NS 1♥; Par +430

West	North	East	South
<i>Alamiro</i>	<i>smispi</i>	<i>EdoWell</i>	<i>jec</i>
1 ♣	Pass	1 ♥	1 NT
2 ♥	Dbl	Pass	3 NT
Pass	Pass	Pass	

3 NT by South

<i>Trick</i>	<i>Lead</i>	<i>2nd</i>	<i>3rd</i>	<i>4th</i>
1. W	♥ 2	7	J	<u>K</u>
2. S	<u>♣ K</u>	3	5	10
3. S	♣ 6	8	<u>A</u>	4
4. N	♣ 9	2	<u>Q</u>	♠ 3
5. S	<u>♣ J</u>	♦ 7	♦ 3	♦ 2
6. S	<u>♣ 7</u>	♠ 7	♦ 4	♦ 8
7. S	♦ <u>A</u>	J	5	10
8. S	<u>♠ K</u>	9	2	4
9. S	♠ 6	Q	<u>A</u>	10
10. N	♠ 5	♥ 6	<u>J</u>	♥ 4

Made 4 — NS +430

**Board 648**  
 North Deals  
 None Vul

♠ 2	♠ J 9 7 5	♠ K Q 6
♥ A J	♥ Q 10 9 8 5	♥ 6 4 2
♦ J 7 5 4 2	♦ K 8 6	♦ A 10 9 3
♣ A K J 10 4	♣ 5	♣ Q 9 3

W	N	E
	S	

♠ A 10 8 4 3
♥ K 7 3
♦ Q
♣ 8 7 6 2

NS 3♠; EW 4♦; EW 4♣; EW 2N; NS 2♥; Par -100: NS 4♠×-1

West	North	East	South
<i>Alamiro</i>	<i>smispi</i>	<i>EdoWell</i>	<i>jec</i>
	Pass	1♦	1♠
2♠	3♥	Pass	Pass
4♥	Pass	5♦	Pass
Pass	Pass		

5♦ by East

Trick	Lead	2nd	3rd	4th
1. S	♠ <u>A</u>	2	5	6
2. S	♥ 3	<u>A</u>	8	2
3. W	♦ 2	6	<u>A</u>	Q
4. E	♠ <u>K</u>	3	♥ J	7
5. E	♦ 10	-	-	-

Made 5 — NS -400

**Board 653**  
 East Deals  
 N-S Vul

♠ K 10 8 5 4 3	♠ Q 9	♠ J 7
♥ 9	♥ Q J 7 6 5 3	♥ 10 4
♦ Q 6 2	♦ A J 9 3	♦ K 8 7 5 4
♣ A Q 10	♣ 6	♣ K J 8 2
	<div style="display: inline-block; background-color: green; color: white; padding: 5px; border: 1px solid black;">           N            W     E                   S         </div>	
	♠ A 6 2	
	♥ A K 8 2	
	♦ 10	
	♣ 9 7 5 4 3	

NS 5♥; NS 2N; EW 2♦; EW 1♠; S 1♣; Par +650

West	North	East	South
<i>gabrielevh</i>	<i>smispi</i>	<i>henkj</i>	<i>jec</i>
		Pass	Pass
2♠ <sup>1</sup>	Pass	2NT <sup>2</sup>	Pass
3♠	4♥	4♠	5♥
Pass	Pass	Pass	

1. 5crd +4+crd min or 6crd 11-12 pts
2. F1R

5♥ by North

<i>Trick</i>	<i>Lead</i>	<i>2nd</i>	<i>3rd</i>	<i>4th</i>
1. E	♠ J	2	<u>K</u>	9
2. W	<u>♣ A</u>	6	8	3
3. W	♥ 9	<u>J</u>	4	2
4. N	♥ 3	10	<u>K</u>	♠ 4

Made 5 — NS +650



**Board 655**  
 West Deals  
 Both Vul

♠ K 9 5 ♥ A K 3 ♦ J 10 9 8 4 ♣ Q 9		♠ A 10 4 ♥ Q 10 9 7 6 5 ♦ 2 ♣ J 5 3	♠ Q J 7 2 ♥ J 2 ♦ Q 6 3 ♣ A 10 6 4
♠ 8 6 3 ♥ 8 4 ♦ A K 7 5 ♣ K 8 7 2			

EW 2N; EW 2♠; NS 2♥; EW 3♦; EW 1♣; Par -120

West	North	East	South
<i>gabrielevh</i>	<i>smispi</i>	<i>henkj</i>	<i>jec</i>
1 ♦	2 ♥	Dbl	Pass
3 ♦	Pass	Pass	Pass

3 ♦ by West

<i>Trick</i>	<i>Lead</i>	<i>2nd</i>	<i>3rd</i>	<i>4th</i>
1. N	♣ 3	4	<u>K</u>	9
2. S	♥ 8	<u>K</u>	7	2
3. W	<u>♣ Q</u>	5	6	7
4. W	♠ 5	<u>A</u>	2	3
5. N	♥ Q	J	4	<u>A</u>
6. W	♠ 9	10	<u>J</u>	6
7. E	<u>♣ A</u>	2	♥ 3	J
8. E	♦ 3	5	<u>8</u>	2
9. W	♦ 4	♥ 5	Q	<u>K</u>
10. S	<u>♦ A</u>	9	♥ 6	6
11. S	♦ 7	<u>10</u>	♠ 4	♣ 10
12. W	<u>♦ J</u>	♥ 9	♠ 7	♣ 8
13. W	<u>♠ K</u>	♥ 10	Q	8

Made 3 — NS -110

**Board 656**  
 North Deals  
 N-S Vul

♠ A 8 ♥ K 10 8 5 3 ♦ K 8 7 ♣ Q 4 3		♠ J 9 2 ♥ 9 4 ♦ A J 10 9 4 ♣ 10 5 2	♠ K Q 10 7 4 ♥ Q ♦ 6 5 3 2 ♣ A J 8
		♠ 6 5 3 ♥ A J 7 6 2 ♦ Q ♣ K 9 7 6	

EW 2N; EW 2♠; EW 2♥; E 2♣; EW 1♦; W 1♣; Par -120

West	North	East	South
<i>gabrielevh</i>	<i>smispi</i>	<i>henkj</i>	<i>jec</i>
	Pass	Pass	Pass
1 ♥	Pass	1 ♠	Pass
1 NT	2 ♦	Pass	Pass
2 ♠	Pass	3 ♠	Pass
Pass	Pass		

3 ♠ by East

<i>Trick</i>	<i>Lead</i>	<i>2nd</i>	<i>3rd</i>	<i>4th</i>
1. S	♦ Q	7	4	2
2. S	♣ 7	3	10	J
3. E	♥ Q	A	3	4
4. S	♥ 6	K	9	♦ 3
5. W	♥ 5	♦ 9	♠ 4	2
6. E	♠ 7	3	A	2
7. W	♥ 8	♦ J	♠ 10	7
8. E	♠ K	5	8	9
9. E	♠ Q	6	♥ 10	J
10. E	♣ A	6	4	2
11. E	♣ 8	K	Q	5
12. S	♣ 9	♦ 8	♦ 10	♦ 5
13. S	♥ J	♦ K	♦ A	♦ 6

Down 1 — NS +50

**Board 658**  
 South Deals  
 Both Vul

♠ A K 10 6 4 3 2	♠ 8 7	♠ Q J 9 5
♥ 9 7	♥ K Q 6 2	♥ A 10 8
♦ J 7 4	♦ A K Q 9	♦ 8
♣ J	♣ A Q 7	♣ 10 5 4 3 2

♠ —
♥ J 5 4 3
♦ 10 6 5 3 2
♣ K 9 8 6

NS 6♦; NS 5♥; EW 4♠; NS 3♣; Par +500; EW 6♠×-2

West	North	East	South
<i>gabrielevh</i>	<i>smispi</i>	<i>henkj</i>	<i>jec</i>
			Pass
3 ♠	Dbl	4 ♠	4 NT
Pass	6 ♦	Pass	Pass
Pass			

6 ♦ by North

Trick	Lead	2nd	3rd	4th
1. E	♠ Q	♦ <u>2</u>	3	7
2. S	♦ 3	4	<u>K</u>	8
3. N	♦ <u>A</u>	♠ 9	5	7
4. N	♦ <u>Q</u>	♠ 5	6	J
5. N	♠ 8	J	♦ <u>10</u>	2
6. S	♥ 3	7	K	<u>A</u>
7. E	♥ 10	4	9	<u>Q</u>

Made 6 — NS +1370

**Board 659**  
 West Deals  
 None Vul

♠ J 7 5 3 2 ♥ Q 7 5 4 3 ♦ Q 6 ♣ J		♠ A 9 8 6 ♥ 2 ♦ A J 9 8 ♣ Q 10 7 3	♠ 10 ♥ A J 9 ♦ K 7 5 4 ♣ A 9 8 5 2
		♠ K Q 4 ♥ K 10 8 6 ♦ 10 3 2 ♣ K 6 4	

NS 3N; NS 2♠; NS 2♣; E 1♥; NS 1♦; Par +400

West	North	East	South
<i>gabrielevh</i>	<i>smispi</i>	<i>henkj</i>	<i>jec</i>
Pass	Pass	1♦	Pass
1♥	Dbl	2♣	2♠
Pass	Pass	3♥	Pass
Pass	Dbl	Pass	Pass
Pass			

3♥× by West

Trick	Lead	2nd	3rd	4th
1. N	♥ 2	9	10	<u>Q</u>
2. W	♠ 2	6	10	<u>Q</u>
3. S	♣ K	J	3	<u>A</u>
4. E	♣ 2	4	<u>♥ 3</u>	7
5. W	♠ 3	8	<u>♥ J</u>	4
6. E	♣ 5	6	<u>♥ 4</u>	10
7. W	♦ Q	<u>A</u>	4	2
8. N	♠ 9	<u>♥ A</u>	K	5
9. E	<u>♦ K</u>	10	6	8
10. E	♦ 7	3	<u>♥ 5</u>	9
11. W	♠ 7	A	♦ 5	<u>♥ 6</u>
12. S	<u>♥ K</u>	7	♣ Q	♣ 8
13. S	♥ 8	♠ J	♦ J	♣ 9

Down 1 — NS +100

**Board 661**  
 East Deals  
 Both Vul

♠ A 3 ♥ 9 ♦ J 10 9 8 5 ♣ Q J 7 6 5	♠ Q J 9 4 2 ♥ K J 5 4 ♦ A K 7 4 ♣ —		♠ K 10 5 ♥ Q 8 7 3 2 ♦ 3 2 ♣ A 10 8
♠ 8 7 6 ♥ A 10 6 ♦ Q 6 ♣ K 9 4 3 2			

NS 4♠; N 3♥; NS 2N; S 2♥; W 2♣; NS 1♦; E 1♣; Par +620

West	North	East	South
<i>gabrielevh</i>	<i>smispi</i>	<i>henkj</i>	<i>jec</i>
		Pass	Pass
2 NT <sup>1</sup>	Dbl	3 ♣	Dbl
Pass	3 ♠	Pass	4 ♠
Pass	Pass	Pass	

1. 2 min 8+

4 ♠ by North

<i>Trick</i>	<i>Lead</i>	<i>2nd</i>	<i>3rd</i>	<i>4th</i>
1. E	♦ 3	<u>Q</u>	10	4
2. S	♠ 6	<u>A</u>	2	5
3. W	♠ 3	Q	<u>K</u>	7
4. E	♠ 10	8	♣ 5	<u>J</u>
5. N	♥ J	2	6	9
6. N	♥ 4	3	<u>10</u>	♣ 6
7. S	♥ A	♦ 5	5	7
8. S	♦ 6	8	<u>A</u>	2
9. N	♠ 9	♣ 8	♣ 2	♣ 7
10. N	♥ K	8	♣ 3	♣ J
11. N	♠ 4	♣ 10	♣ 4	♣ Q
12. N	♦ K	♣ A	♣ 9	9
13. N	♦ 7	♥ Q	♣ K	<u>J</u>

Made 4 — NS +620

**Board 663**  
West Deals  
N-S Vul

♠ A J 3 2 ♥ 10 6 ♦ A K 10 9 ♣ Q 8 3		♠ 9 6 5 ♥ A 5 4 ♦ Q J 8 7 2 ♣ A 10	♠ K Q 8 7 4 ♥ K 9 7 2 ♦ 5 3 ♣ 6 5
♠ 10 ♥ Q J 8 3 ♦ 6 4 ♣ K J 9 7 4 2			

EW 4♠; EW 2N; NS 2♣; W 1♥; EW 1♦; Par -420

West	North	East	South
<i>gabrielevh</i>	<i>smispi</i>	<i>henkj</i>	<i>jec</i>
1 ♦	Pass	1 ♠	2 ♣
2 ♠	3 ♣	3 ♠	Pass
Pass	Pass		

3 ♠ by East

<i>Trick</i>	<i>Lead</i>	<i>2nd</i>	<i>3rd</i>	<i>4th</i>
1. S	♣ 9	Q	<u>A</u>	6
2. N	<u>♣ 10</u>	5	2	3
3. N	♥ 4	<u>K</u>	8	6
4. E	♥ 2	3	10	<u>A</u>
5. N	♦ J	5	6	<u>A</u>
6. W	♠ 2	5	<u>K</u>	10
7. E	♥ 9	J	<u>♠ 3</u>	5
8. W	<u>♠ A</u>	6	4	♣ 4
9. W	♣ 8	♦ 2	<u>♠ 7</u>	7
10. E	♥ 7	Q	<u>♠ J</u>	♦ 7
11. W	<u>♦ K</u>	8	3	4
12. W	♦ 9	Q	<u>♠ 8</u>	♣ J
13. E	<u>♠ Q</u>	♣ K	♦ 10	9

Made 4 — NS -170

**Board 669**  
 East Deals  
 E-W Vul

♠ A Q 8 2		♠ K 7 6 5
♥ Q 6 3		♥ 8 5 4
♦ 6 4 3		♦ Q J
♣ K J 5		♣ Q 9 7 6
♠ 9 3		♥ A K J 9 2
	♦ K 9 8 7	
	♣ 10 3	

NS 3♥; NS 4♦; NS 1N; EW 1♠; S 1♣; Par +140

West	North	East	South
<i>faramarz</i>	<i>ronpa</i>	<i>PhilippeIV</i>	<i>jec</i>
		Pass	Pass
1♣	Pass	1♠	Dbl
2♠	3♦	Pass	Pass

Pass

3♦ by North

Trick	Lead	2nd	3rd	4th
1. E	♠ 6	3	<u>A</u>	4
2. W	♠ 2	10	<u>K</u>	9
3. E	♣ 7	3	<u>K</u>	2
4. W	♣ J	<u>A</u>	6	10
5. N	<u>♦ A</u>	J	7	4
6. N	♦ 2	Q	<u>K</u>	3
7. S	<u>♦ 8</u>	6	5	♠ 5
8. S	<u>♥ A</u>	3	7	5
9. S	<u>♥ K</u>	6	10	4
10. S	♥ J	Q	<u>♦ 10</u>	8

Made 4 — NS +130

**Board 673**  
 East Deals  
 Both Vul

♠ —	♠ Q 9 8 7 2	♠ A K 6
♥ Q 10 9 8 3	♥ A K 6 5	♥ 7 2
♦ 10 6	♦ J 5 2	♦ K 9 8 7 3
♣ J 10 9 8 7 6	♣ Q	♣ K 5 3

N	
W	E
S	

♠ J 10 5 4 3
♥ J 4
♦ A Q 4
♣ A 4 2

NS 4♠; N 2N; EW 2♣; S 1♥; NS 1♦; Par +620

West	North	East	South
<i>faramarz</i>	<i>ronpa</i>	<i>PhilippeIV</i>	<i>jec</i>
		1♦	1♠
Pass	2♦	Pass	2♠
2NT	4♠	Pass	Pass

Pass

4♠ by South

<i>Trick</i>	<i>Lead</i>	<i>2nd</i>	<i>3rd</i>	<i>4th</i>
1. W	♦ 10	2	3	<u>Q</u>
2. S	♠ 3	♣ J	7	<u>K</u>
3. E	♠ A	4	♣ 6	2
4. E	♠ 6	J	♥ 3	8
5. S	♥ J	Q	<u>K</u>	7
6. N	♥ A	2	4	8
7. N	♥ 5	♦ 7	<u>♠ 5</u>	9
8. S	♣ A	7	Q	3
9. S	♣ 2	8	<u>♠ 9</u>	K
10. N	♥ 6	♦ 8	<u>♠ 10</u>	10
11. S	♣ 4	9	<u>♠ Q</u>	5
12. N	♦ 5	9	<u>A</u>	6
13. S	♦ 4	♣ 10	J	<u>K</u>

Made 4 — NS +620



**Board 679**  
 West Deals  
 E-W Vul

♠ K 8 6 5 ♥ A ♦ A Q 9 7 5 ♣ Q 9 2		♠ A J ♥ J 9 8 6 5 4 ♦ — ♣ A J 7 6 4	♠ 10 4 ♥ Q 3 2 ♦ K J 8 6 ♣ 10 8 5 3
♠ Q 9 7 3 2 ♥ K 10 7 ♦ 10 4 3 2 ♣ K			

NS 5♥; EW 2♦; NS 2♣; NS 1♠; Par +450

West	North	East	South
<i>faramarz</i>	<i>ronpa</i>	<i>PhilippeIV</i>	<i>jec</i>
1 ♦	1 ♥	2 ♦	Dbl
2 ♠	4 ♣	4 ♦	4 ♥
5 ♦	Pass	Pass	Pass

5♦ by West

<i>Trick</i>	<i>Lead</i>	<i>2nd</i>	<i>3rd</i>	<i>4th</i>
1. N	♥ 5	2	10	<u>A</u>
2. W	♦ Q	♣ 7	6	2
3. W	♦ 5	♥ 4	<u>K</u>	3
4. E	♠ 4	2	K	<u>A</u>
5. N	♥ J	3	7	<u>♦ 7</u>
6. W	♠ 5	<u>J</u>	10	3
7. N	♥ 6	Q	K	<u>♦ 9</u>
8. W	♠ 6	♣ 4	<u>♦ 8</u>	7
9. E	♣ 3	<u>K</u>	2	6
10. S	♦ 4	<u>A</u>	♥ 8	J
11. W	♠ 8	♣ J	♣ 5	<u>9</u>
12. S	<u>♦ 10</u>	♣ 9	♥ 9	♣ 8
13. S	<u>♠ Q</u>	♣ Q	♣ A	♣ 10

Down 4 — NS +400

**Board 689**  
 East Deals  
 Both Vul

♠ 9 8 7 3		♠ A 5 2
♥ J 10 9 3 2		♥ K 6 5
♦ Q 10 4		♦ 7
♣ 5		♣ A J 10 8 7 4
♠ K J 4		♥ A Q
		♦ A K 6 5 2
		♣ 9 6 3
		♠ Q 10 6
		♥ 8 7 4
		♦ J 9 8 3
		♣ K Q 2

EW 3♥; EW 2♠; EW 3♦; N 3♣; S 2♣; Par -140

West	North	East	South
<i>faramarz</i>	<i>ronpa</i>	<i>PhilippeIV</i>	<i>jec</i>
		1 NT	Pass
2 ♣	Dbl	Pass <sup>1</sup>	Pass
Rdbl <sup>2</sup>	Pass	2 ♦	Pass
2 ♥	Pass	2 ♠	Pass
Pass	Pass		

1. no Cl stopper

2. MM Weak

2 ♠ by East

<i>Trick</i>	<i>Lead</i>	<i>2nd</i>	<i>3rd</i>	<i>4th</i>
1. S	<u>♣ K</u>	5	J	3
2. S	<u>♣ Q</u>	<u>♠ 3</u>	7	6
3. W	♥ 2	5	<u>Q</u>	4
4. E	<u>♦ A</u>	3	4	7
5. E	♦ 2	8	Q	<u>♠ 2</u>
6. N	♣ 10	9	2	<u>♠ 7</u>
7. W	♦ 10	<u>♠ 5</u>	5	9
8. N	♣ 4	♦ 6	♦ J	<u>♠ 8</u>
9. W	♠ 9	<u>A</u>	4	6
10. N	♣ 8	♠ J	<u>♠ Q</u>	♥ 3
11. S	♥ 8	9	6	<u>A</u>
12. E	<u>♠ K</u>	10	♥ 10	♣ A
13. E	<u>♦ K</u>	♥ 7	♥ J	♥ K

Made 2 — NS -110

**Board 690**  
 South Deals  
 None Vul

	♠ 2		
	♥ A K Q 8 5 3 2		
	♦ 7 3 2		
	♣ Q 4		
♠ A J 10 9 3 ♥ 6 ♦ Q 8 ♣ A K 10 6 2	<div style="background-color: green; color: white; padding: 10px; display: inline-block;">           N W     E S         </div>	♠ K Q 8 4 ♥ 4 ♦ A J 9 4 ♣ J 9 5 3	
	♠ 7 6 5		
	♥ J 10 9 7		
	♦ K 10 6 5		
	♣ 8 7		

EW 5♠; EW 5♣; NS 2♥; EW 1♦; Par -450

West	North	East	South
<i>faramarz</i>	<i>ronpa</i>	<i>PhilippeIV</i>	<i>jec</i>
			Pass
1 ♠	3 ♥	4 ♥	5 ♥
5 ♠	Pass	Pass	Pass

5 ♠ by West

<i>Trick</i>	<i>Lead</i>	<i>2nd</i>	<i>3rd</i>	<i>4th</i>
1. N	♥ <u>K</u>	4	J	6
2. N	♦ 7	4	<u>K</u>	8
3. S	♣ 8	<u>A</u>	4	3
4. W	♠ <u>10</u>	2	4	5
5. W	♠ 3	♥ A	<u>Q</u>	6
6. E	♠ 8	7	<u>J</u>	♥ 8
7. W	♦ <u>Q</u>	2	9	5
8. W	♠ 9	♥ 2	<u>K</u>	♦ 6
9. E	♦ <u>A</u>	10	♣ 2	3
10. E	♦ <u>J</u>	♥ 7	♣ 6	♥ Q
11. E	♣ 5	7	<u>K</u>	Q

Made 5 — NS -450

**Board 692**  
 North Deals  
 None Vul

♠ J 7 4 3	♠ Q	♠ A K 10 6
♥ Q 10 8 5	♥ K 6 2	♥ J 7 3
♦ Q 5 4	♦ 10 6 3	♦ A J 9 7 2
♣ 7 3	♣ Q J 10 8 6 2	♣ K
	<div style="display: inline-block; background-color: #008000; color: white; padding: 5px; text-align: center; margin: 0 5px;">       N W     E S     </div>	
	♠ 9 8 5 2	
	♥ A 9 4	
	♦ K 8	
	♣ A 9 5 4	

NS 4♣; NS 2N; EW 2♠; EW 2♦; EW 1♥; Par +130

West	North	East	South
<i>carlosp</i>	<i>BridgeGoth</i>	<i>hectorc</i>	<i>jec</i>
	Pass	1 ♦	Pass
Pass	2 ♣	Dbl	2 ♦
Dbl	Pass	Pass	3 ♣
Pass	Pass	Pass	

3 ♣ by North

<i>Trick</i>	<i>Lead</i>	<i>2nd</i>	<i>3rd</i>	<i>4th</i>
1. E	♠ <u>A</u>	2	3	Q
2. E	♠ K	5	4	<u>♣ 2</u>
3. N	♣ Q	K	-	-

Made 4 — NS +130

**Board 693**  
 East Deals  
 N-S Vul

♠ A 9		♠ K Q 10 7 2
♥ A K J 9 7 3		♥ Q 2
♦ —		♦ K J 10 9
♣ Q J 5 4 2		♣ A 9
	<div style="display: inline-block; background-color: green; color: white; padding: 5px; border: 1px solid black;">           N W    E S         </div>	♠ J
		♥ 8 5 4
		♦ 8 6 5 3 2
		♣ K 10 6 3
		♠ 8 6 5 4 3
		♥ 10 6
		♦ A Q 7 4
		♣ 8 7

EW 6♥; EW 6♣; NS 2♠; EW 1N; NS 2♦; Par -980

West	North	East	South
<i>carlosp</i>	<i>BridgeGoth</i>	<i>hectorc</i>	<i>jec</i>
		Pass	Pass
1 ♥	1 ♠	2 ♥	4 ♠
5 ♣	Pass	5 ♥	Pass
Pass	Pass		

5 ♥ by West

<i>Trick</i>	<i>Lead</i>	<i>2nd</i>	<i>3rd</i>	<i>4th</i>
1. N	♠ K	J	3	<u>A</u>
2. W	♥ <u>A</u>	2	4	6
3. W	♠ 9	2	♥ <u>5</u>	4
4. E	♥ 8	10	<u>K</u>	Q

Made 6 — NS -480

**Board 699**  
 West Deals  
 None Vul

♠ K Q 7		♠ 3
♥ K		♥ A Q 10 9 8 5 4 3 2
♦ K 9 7 6 2		♦ J
♣ A 8 6 4		♣ 5 3
♠ 9 8 2		♥ J 7
♥ J 7	♦ A 10 4 3	♠ A J 10 6 5 4
♦ A 10 4 3	♣ K Q 10 9	♥ 6
♣ K Q 10 9	♠ 3	♦ Q 8 5
		♣ J 7 2

EW 4N; EW 4♥; NS 3♠; NS 1♦; NS 1♣; Par -300; NS 5♠×-2

West	North	East	South
<i>carlosp</i>	<i>BridgeGoth</i>	<i>hectorc</i>	<i>jec</i>
1 NT	Pass	2 ♦	2 ♠
Pass	Pass	3 ♠	Pass
3 NT	Pass	4 ♦	Pass
4 ♥	Pass	Pass	Pass

4 ♥ by West

<i>Trick</i>	<i>Lead</i>	<i>2nd</i>	<i>3rd</i>	<i>4th</i>
1. N	♣ K	3	7	<u>A</u>
2. W	♥ <u>K</u>	7	2	6
3. W	♠ Q	9	3	<u>A</u>
4. S	♣ J	4	<u>Q</u>	5
5. N	♦ A	J	5	-

Made 4 — NS -420

**Board 700**  
 North Deals  
 E-W Vul

♠ Q 6 4 2 ♥ A Q 9 4 2 ♦ 8 4 ♣ 9 8	♠ K J 9 7 ♥ 10 6 3 ♦ Q 5 3 ♣ A J 10	<div style="background-color: green; color: white; padding: 10px; display: inline-block;">           N            W     E                   S         </div>	♠ 10 8 3 ♥ K 8 7 ♦ A 10 9 ♣ K Q 7 6
♠ A 5 ♥ J 5 ♦ K J 7 6 2 ♣ 5 4 3 2			

EW 2♥; NS 2♦; EW 1♠; N 1♣; Par -100; NS 3♦×-1

West	North	East	South
<i>carlosp</i>	<i>BridgeGoth</i>	<i>hectorc</i>	<i>jec</i>
	Pass	1 ♣	1 ♦
Dbl <sup>1</sup>	Rdbl	1 ♥	Pass
2 ♥	3 ♦	Pass	Pass

Pass

1. ♥

3 ♦ by South

<i>Trick</i>	<i>Lead</i>	<i>2nd</i>	<i>3rd</i>	<i>4th</i>
1. W	♣ 9	10	<u>Q</u>	2
2. E	♥ 7	5	<u>Q</u>	3
3. W	<u>♥ A</u>	6	8	J
4. W	♣ 8	<u>A</u>	6	3
5. N	♦ 3	9	<u>J</u>	4
6. S	<u>♠ A</u>	2	7	3
7. S	♠ 5	4	<u>J</u>	8
8. N	<u>♠ K</u>	10	♣ 4	6
9. N	♠ 9	♣ 7	<u>♦ 2</u>	Q
10. S	♣ 5	♥ 4	J	<u>K</u>
11. E	♥ K	<u>♦ 6</u>	2	10
12. S	♦ 7	8	Q	<u>A</u>
13. E	♦ 10	<u>K</u>	♥ 9	5

Down 1 — NS -50

**Board 707**  
 West Deals  
 E-W Vul

♠ 10 8		♠ A 6 3
♥ K J 8 7		♥ A 5 4 3
♦ J 10 8 6 2		♦ K 9 4 3
♣ J 6		♣ Q 5
♠ K Q 9	<div style="display: inline-block; background-color: green; color: white; padding: 5px; border: 1px solid black;">           N            W     E            S         </div>	♠ J 7 5 4 2
♥ Q 10 9 6 2		♥ —
♦ 7 5		♦ A Q
♣ 9 7 4		♣ A K 10 8 3 2

NS 3♠; NS 2N; NS 3♣; NS 1♥; NS 1♦; Par +140

West	North	East	South
<i>carlosp</i>	<i>BridgeGoth</i>	<i>hectorc</i>	<i>jec</i>
Pass	Pass	1♦	2♣
Pass	Pass	Dbl	2♠
3♥	Pass	Pass	Dbl
Pass	Pass	Pass	

3♥× by West

Trick	Lead	2nd	3rd	4th
1. N	♠ 10	3	2	<u>Q</u>
2. W	♣ 4	6	Q	<u>K</u>
3. S	♠ 4	9	8	<u>A</u>
4. E	♣ 5	<u>A</u>	7	J
5. S	♠ 5	K	<u>♥ 7</u>	6
6. N	♦ 2	K	<u>A</u>	5
7. S	<u>♦ Q</u>	7	6	3
8. S	♣ 10	9	♥ 8	<u>♥ A</u>
9. E	♥ 3	♣ 2	9	<u>J</u>
10. N	<u>♥ K</u>	4	♣ 3	2
11. N	♦ J	-	-	-

Down 3 — NS +800



**Board 708**  
 North Deals  
 None Vul

♠ A Q J	<div style="display: inline-block; background-color: green; color: white; padding: 10px; border: 1px solid black;">           N W     E S         </div>	♠ 10 8 7 6 4
♥ K 10		♥ A J 8 7 6 2
♦ K Q J 3 2		♦ 8
♣ 10 8 3		♣ J
	♠ K 9 5 3 2	
	♥ 9	
	♦ A 10 4	
	♣ Q 6 5 2	

W 3♥; EW 2♠; E 2♥; S 3♣; EW 1N; N 2♣; Par -100; S 4♣×-1

West	North	East	South
<i>carlosp</i>	<i>BridgeGoth</i>	<i>hectorc</i>	<i>jec</i>
	Pass	2♥	2♠
Dbl <sup>1</sup>	2NT	Pass	Pass
Dbl	3♣	Pass	Pass
Pass			

1. penalty  
 3♣ by North

Trick	Lead	2nd	3rd	4th
1. E	♦ 8	<u>A</u>	3	5
2. S	♥ 9	<u>K</u>	3	2
3. W	♣ 3	<u>K</u>	J	2
4. N	♥ 4	6	<u>♣ 5</u>	10
5. S	♠ 2	Q	<u>♣ 4</u>	4
6. N	♥ 5	7	<u>♣ Q</u>	♠ J
7. S	♣ 6	8	<u>9</u>	♠ 6
8. N	♦ 6	♥ 8	10	<u>Q</u>
9. W	<u>♦ K</u>	7	♠ 7	4
10. W	<u>♦ J</u>	9	♠ 8	♠ 3
11. W	♦ 2	<u>♣ 7</u>	♠ 10	♠ 5
12. N	<u>♣ A</u>	♥ J	♠ 9	10
13. N	♥ Q	<u>A</u>	♠ K	♠ A

Down 1 — NS -50

**Board 711**  
West Deals  
Both Vul

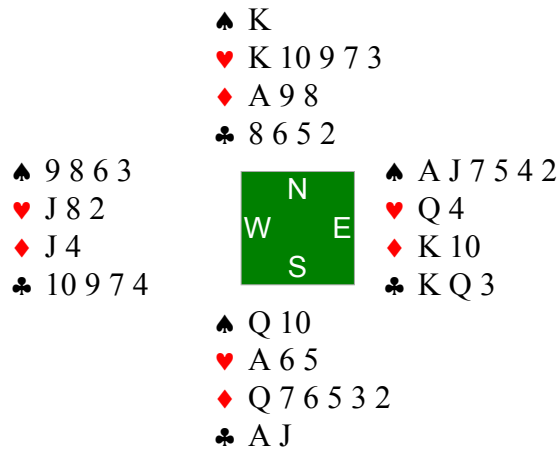

NS 3♥; NS 4♦; EW 2♠; NS 1N; Par +140

West	North	East	South
<i>carlosp</i>	<i>BridgeGoth</i>	<i>hectorc</i>	<i>jec</i>
Pass	Pass	1 ♠	2 ♦
Pass	3 ♦	Pass	Pass
Pass			

3 ♦ by South

<i>Trick</i>	<i>Lead</i>	<i>2nd</i>	<i>3rd</i>	<i>4th</i>
1. W	♠ 6	K	<u>A</u>	10
2. E	♣ 3	<u>A</u>	4	2
3. S	♦ 2	4	<u>A</u>	10
4. N	♦ 8	<u>K</u>	3	J
5. E	<u>♣ K</u>	J	7	5
6. E	♣ Q	<u>♦ 5</u>	9	6
7. S	<u>♠ Q</u>	3	♣ 8	2
8. S	♥ 5	2	<u>K</u>	Q
9. N	♥ 3	4	6	<u>8</u>
10. W	♥ J	-	-	-

Made 3 — NS +110

**Board 712**  
 North Deals  
 N-S Vul

♠ 9 8 3 2 ♥ K 8 3 ♦ 7 6 ♣ A 8 5 4	♠ A J 6 5 ♥ J 10 4 2 ♦ 9 3 2 ♣ 10 3		♠ Q 10 4 ♥ Q 7 6 ♦ K J 10 8 ♣ K J 9
	♠ K 7 ♥ A 9 5 ♦ A Q 5 4 ♣ Q 7 6 2		

NS 2♥; EW 1N; NS 1♠; E 1♣; Par +100; EW 2N×-1

West	North	East	South
<i>carlosp</i>	<i>BridgeGoth</i>	<i>hectorc</i>	<i>jec</i>
	Pass	1♦	1NT
Pass	Pass	Pass	

1 NT by South

<i>Trick</i>	<i>Lead</i>	<i>2nd</i>	<i>3rd</i>	<i>4th</i>
1. W	♦ 7	2	8	<u>Q</u>
2. S	♦ 4	6	9	<u>10</u>
3. E	♦ J	<u>A</u>	♣ 4	3
4. S	♣ 2	5	10	<u>J</u>
5. E	♦ K	5	♠ 2	♥ 2
6. E	♣ K	6	8	3
7. E	♣ 9	Q	<u>A</u>	♥ 4
8. W	♠ 8	5	10	<u>K</u>
9. S	♣ 7	♠ 3	♥ J	♥ 6
10. S	♠ 7	9	<u>A</u>	4
11. N	♥ 10	7	5	<u>K</u>
12. W	♥ 3	♠ 6	Q	<u>A</u>
13. S	♥ 9	8	♠ J	♠ Q

Made 1 — NS +90

**Board 713**  
 East Deals  
 E-W Vul

♠ 4 2 ♥ A 10 9 3 ♦ K Q 10 ♣ Q 10 5 3		♠ K 5 3 ♥ 8 4 ♦ A J 9 7 6 3 ♣ K 8	♠ A Q J 9 8 7 6 ♥ 7 ♦ 8 4 2 ♣ 4 2
		♠ 10 ♥ K Q J 6 5 2 ♦ 5 ♣ A J 9 7 6	

EW 3♠; NS 3♥; EW 2N; NS 2♣; N 1♦; Par -100; NS 4♥×-1

West	North	East	South
<i>carlosp</i>	<i>BridgeGoth</i>	<i>hectorc</i>	<i>jec</i>

3 ♠      4 ♥

Dbl                  Pass                  Pass                  Pass

4 ♥× by South

<i>Trick</i>	<i>Lead</i>	<i>2nd</i>	<i>3rd</i>	<i>4th</i>
1. W	♠ 4	3	<u>J</u>	10
2. E	♥ 7	J	<u>A</u>	4
3. W	♥ 9	8	♠ 6	<u>Q</u>
4. S	♣ J	Q	<u>K</u>	2
5. N	♠ 5	7	<u>♥ 2</u>	2
6. S	♦ 5	K	<u>A</u>	8
7. N	♣ 8	4	9	<u>10</u>
8. W	♦ Q	3	2	<u>♥ 5</u>
9. S	<u>♣ A</u>	3	♦ 6	♠ 8
10. S	<u>♣ 6</u>	5	♦ 7	♠ 9
11. S	♣ 7	<u>♥ 3</u>	♦ 9	♦ 4
12. W	♥ 10	♦ J	♠ Q	<u>K</u>
13. S	<u>♥ 6</u>	♦ 10	♠ K	♠ A

Down 1 — NS -100

**Board 715**  
 West Deals  
 None Vul

♠ K 9		♠ J 8 6 4 2
♥ A Q 8 6		♥ J 7 3 2
♦ Q 10 3		♦ 8 4
♣ A 7 6 4		♣ 5 3
♠ 5		♥ K 4

♦ A 9 6 5  
♣ K Q J 10 8 2

S 3N; S 5♦; S 5♣; N 4♦; N 4♣; N 2N; S 1♠; EW 1♥; Par +400

West	North	East	South
<i>carlosp</i>	<i>BridgeGoth</i>	<i>hectorc</i>	<i>jec</i>
1 NT	2 ♥ <sup>1</sup>	Pass	2 ♠
Pass	Pass	Pass	

1. ♠

2 ♠ by South

<i>Trick</i>	<i>Lead</i>	<i>2nd</i>	<i>3rd</i>	<i>4th</i>
1. W	♦ 3	2	4	<u>5</u>
2. S	♠ 5	9	<u>Q</u>	2
3. N	♠ <u>A</u>	4	♣ 2	K
4. N	♠ 3	<u>6</u>	♣ 8	♣ 7
5. E	♥ 3	4	<u>Q</u>	5
6. W	♦ 10	<u>J</u>	8	6
7. N	♣ 9	3	<u>Q</u>	<u>A</u>
8. W	♦ Q	K	<u>♠ 8</u>	9
9. E	♥ 2	K	<u>A</u>	9
10. W	♥ 8	10	<u>J</u>	♣ 10
11. E	♠ <u>J</u>	♣ J	♣ 4	7
12. E	♥ 7	♣ K	6	<u>♠ 10</u>
13. N	♦ 7	♣ 5	<u>A</u>	♣ 6

Down 2 — NS -100

**Board 720**  
 North Deals  
 None Vul

♠ A Q 6 ♥ 9 7 5 3 2 ♦ 4 ♣ 10 7 4 2		♠ K 7 5 3 2 ♥ K 10 ♦ A 10 5 2 ♣ 9 3	♠ J 8 4 ♥ 8 ♦ K J 9 8 6 3 ♣ A Q J
		♠ 10 9 ♥ A Q J 6 4 ♦ Q 7 ♣ K 8 6 5	

NS 2N; NS 2♥; NS 1♠; EW 1♦; N 1♣; Par +120

West	North	East	South
<i>StuC</i>	<i>smispi</i>	<i>lella1</i>	<i>jec</i>
	Pass	1♦	1♥
Pass	1♠	2♦	Pass
Pass	2♥	Pass	Pass
Pass			

2♥ by South

Trick	Lead	2nd	3rd	4th
1. W	♦ 4	2	<u>K</u>	7
2. E	♦ 3	Q	<u>♥ 2</u>	5
3. W	♠ A	2	4	10
4. W	♠ Q	<u>K</u>	8	9
5. N	♣ 3	<u>A</u>	5	2
6. E	♦ 6	♣ 6	<u>♥ 3</u>	10
7. W	♠ 6	7	J	<u>♥ 4</u>
8. S	<u>♥ A</u>	5	10	8
9. S	♥ 6	7	<u>K</u>	♦ 8
10. N	♦ A	9	♣ 8	<u>♥ 9</u>
11. W	♣ 4	-	-	-

Down 1 — NS -50

**Board 723**  
 West Deals  
 Both Vul

♠ Q 6 ♥ J 10 3 ♦ J 6 4 2 ♣ 8 7 4 2		♠ A 8 5 3 2 ♥ 8 2 ♦ A 9 8 7 3 ♣ J	♠ 7 4 ♥ Q 9 6 ♦ K Q 5 ♣ A Q 9 6 3
♠ K J 10 9 ♥ A K 7 5 4 ♦ 10 ♣ K 10 5			

NS 6♠; NS 4♥; NS 3N; NS 3♦; NS 1♣; Par +1430

West	North	East	South
<i>StuC</i>	<i>smispi</i>	<i>lella1</i>	<i>jec</i>
Pass	Pass	1 ♣	1 ♥
Pass	1 ♠	Pass	3 ♠
Pass	4 ♣	Dbl	4 ♠
Pass	Pass	Pass	

4 ♠ by North

<i>Trick</i>	<i>Lead</i>	<i>2nd</i>	<i>3rd</i>	<i>4th</i>
1. E	♦ K	10	2	<u>A</u>
2. N	♥ 2	6	<u>A</u>	3
3. S	♥ <u>K</u>	10	8	9
4. S	♥ 4	J	<u>♠ 8</u>	Q
5. N	♣ J	<u>A</u>	5	2
6. E	♣ 3	<u>10</u>	4	♦ 3
7. S	<u>♣ K</u>	7	♦ 8	6
8. S	<u>♠ K</u>	6	2	4
9. S	♠ 9	Q	<u>A</u>	7

Made 6 — NS +680

**Board 727**  
 West Deals  
 None Vul

♠ Q 5 2 ♥ A 5 3 ♦ A K 8 2 ♣ 5 4 3		♠ A 10 4 ♥ K Q 8 ♦ J 6 4 ♣ A Q 10 6	♠ K 9 8 7 6 3 ♥ 10 ♦ Q 9 7 3 ♣ 9 2
♠ J ♥ J 9 7 6 4 2 ♦ 10 5 ♣ K J 8 7			

EW 4♠; NS 4♥; EW 2♦; NS 2♣; Par -100; NS 5♥×-1

West	North	East	South
<i>StuC</i>	<i>smispi</i>	<i>lella1</i>	<i>jec</i>
1 ♦	Dbl	1 ♠ <sup>1</sup>	2 ♥
2 ♠	Dbl <sup>2</sup>	Pass	4 ♥
Pass	Pass	4 ♠	Pass
Pass	5 ♥	Pass	Pass
Pass			

1. pmax 10 pts

2. game try

5 ♥ by South

<i>Trick</i>	<i>Lead</i>	<i>2nd</i>	<i>3rd</i>	<i>4th</i>
1. W	<u>♦ A</u>	4	7	10
2. W	<u>♦ K</u>	6	3	5
3. W	♦ 2	J	Q	<u>♥ 2</u>
4. S	♥ 4	3	<u>Q</u>	10

Down 1 — NS -50



**Board 728**  
 North Deals  
 E-W Vul

♠ J 10 8 6 3	♠ Q 9 5 2	♠ A K 7 4
♥ A 5 2	♥ 10 8 4	♥ K J 3
♦ Q	♦ 9 6 2	♦ K 8
♣ A K J 3	♣ Q 5 2	♣ 10 8 7 4
	♠ —	
	♥ Q 9 7 6	
	♦ A J 10 7 5 4 3	
	♣ 9 6	

EW 5♠; EW 4N; E 5♣; EW 3♥; W 4♣; NS 1♦; Par -650

West	North	East	South
<i>StuC</i>	<i>smispi</i>	<i>lella1</i>	<i>jec</i>
	Pass	1 ♣	4 ♦ <sup>1</sup>
4 ♠	Pass	Pass	Pass

1. nat

4 ♠ by West

<i>Trick</i>	<i>Lead</i>	<i>2nd</i>	<i>3rd</i>	<i>4th</i>
1. N	♦ 2	8	10	Q
2. W	♠ 3	2	<u>A</u>	♦ 3
3. E	♣ 4	6	<u>A</u>	2
4. W	♠ J	Q	<u>K</u>	♦ 4
5. E	♥ 3	7	<u>A</u>	4
6. W	♥ 2	8	J	Q
7. S	♦ <u>A</u>	♣ 3	6	K
8. S	♣ 9	<u>K</u>	5	7
9. W	♣ J	Q	8	♦ 5

Down 1 — NS +100

**Board 733**  
 East Deals  
 None Vul

♠ 10 9 2	♠ K 4	♠ A Q J 8 7 6 5 3
♥ 2	♥ J 8 7 5	♥ Q 6
♦ Q J 4 3	♦ A 8 2	♦ 7 6 5
♣ 10 8 7 6 5	♣ A K J 3	♣ —

♠ —	♠ —
♥ A K 10 9 4 3	♥ —
♦ K 10 9	♦ —
♣ Q 9 4 2	♣ —

N 6N; N 6♥; NS 6♣; S 5♥; EW 4♠; NS 3♦; Par +500; EW 7♠×-3

West	North	East	South
<i>StuC</i>	<i>smispi</i>	<i>lella1</i>	<i>jec</i>
		3 ♠	4 ♥
Pass	5 ♣ <sup>1</sup>	Pass	5 ♦
Pass	6 ♥	Pass	Pass
6 ♠	Dbl	Pass	Pass
Pass			

1. cue

6 ♠× by East

Trick	Lead	2nd	3rd	4th
1. S	♥ A	2	7	6
2. S	♣ 2	8	K	♠ 3
3. E	♠ A	♥ 3	2	4
4. E	♦ 5	9	J	A
5. N	♠ K	5	♥ 4	9
6. N	♣ 3	♠ 6	4	5
7. E	♦ 6	K	3	8

Down 3 — NS +500

**Board 735**  
 West Deals  
 E-W Vul

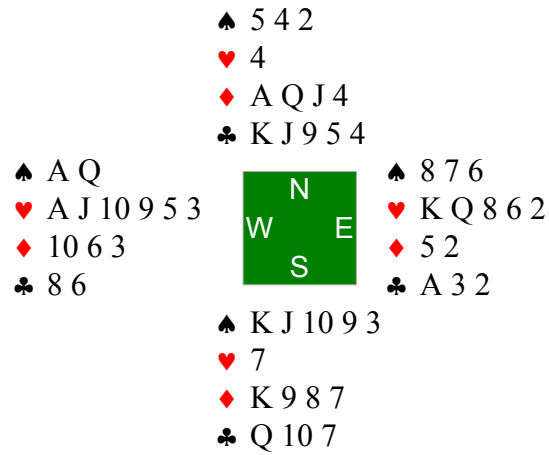

EW 4♥; EW 3N; NS 2♠; NS 2♦; NS 2♣; Par -300: NS 4♠×-2

West	North	East	South
<i>StuC</i>	<i>smispi</i>	<i>lalla1</i>	<i>jec</i>
1 ♥	Pass	4 ♥	4 ♠
Pass	Pass	5 ♥	Pass
Pass	Pass		

5 ♥ by West

<i>Trick</i>	<i>Lead</i>	<i>2nd</i>	<i>3rd</i>	<i>4th</i>
1. N	♠ 2	6	9	<u>Q</u>
2. W	♥ <u>A</u>	4	2	7
3. W	♦ 3	4	5	<u>7</u>
4. S	♠ K	<u>A</u>	5	7
5. W	♦ 6	<u>J</u>	2	8
6. N	♠ 4	8	10	♥ <u>3</u>
7. W	♦ 10	Q	♥ <u>6</u>	9
8. E	♣ <u>A</u>	7	6	4
9. E	♣ 2	10	8	<u>J</u>
10. N	♣ K	3	Q	-

Down 1 — NS +100

**Board 736**  
 North Deals  
 None Vul

♠ A 10 9 4 ♥ J 10 4 ♦ 10 4 2 ♣ K 10 5		♠ K J 8 6 3 ♥ 8 ♦ — ♣ J 8 7 6 4 3 2	♠ Q 2 ♥ K Q 7 3 ♦ A J 6 5 3 ♣ A Q
♠ 7 5 ♥ A 9 6 5 2 ♦ K Q 9 8 7 ♣ 9			

EW 3N; W 2♥; EW 2♦; EW 1♠; E 1♥; NS 1♣; Par -400

West	North	East	South
<i>StuC</i>	<i>smispi</i>	<i>lella1</i>	<i>jec</i>
	Pass	1 ♦	1 ♥
Dbl	2 ♣	Dbl	Pass
2 ♦	Pass	2 NT	Pass
Pass	Pass		

2 NT by East

<i>Trick</i>	<i>Lead</i>	<i>2nd</i>	<i>3rd</i>	<i>4th</i>
1. S	♣ 9	5	7	<u>Q</u>
2. E	♥ 3	2	<u>J</u>	8
3. W	♦ 2	♣ 4	J	<u>Q</u>
4. S	♦ K	4	♣ 2	<u>A</u>
5. E	♦ 3	7	<u>10</u>	♠ 3
6. W	♠ 4	<u>K</u>	2	7
7. N	♣ 3	<u>A</u>	♥ 6	10
8. E	♠ Q	5	9	6
9. E	♦ 5	<u>8</u>	♠ 10	♣ 6
10. S	<u>♦ 9</u>	♥ 4	♠ 8	6
11. S	<u>♥ A</u>	10	♠ J	7
12. S	♥ 5	-	-	-

Made 2 — NS -120

**Board 741**  
 East Deals  
 N-S Vul

♠ K Q 6 5		♠ J 8 3
♥ A K 10 5 4		♥ J 9 6 2
♦ 10 5		♦ 4 3 2
♣ A 10		♣ 8 7 3
♠ 10 7 4 2		♥ Q
♥ 8 7 3	♦ A J 9 6	♣ 8 7 3
♦ K Q 8 7	♠ 10 7 4 2	♥ Q
♣ K J 6 2	♦ A J 9 6	♦ A J 9 6
♠ A 9	♣ Q 9 5 4	♣ Q 9 5 4

EW 3♥; NS 4♦; NS 4♣; EW 1♠; Par +100; EW 4♥×-1

West	North	East	South
<i>EdoWell</i>	<i>smispi</i>	<i>Harmon</i>	<i>jec</i>
		Pass	Pass
1♥	Pass	Pass	Dbl
Rdbl	2♦	Pass	Pass

Pass

2♦ by North

Trick	Lead	2nd	3rd	4th
1. E	♥ 2	Q	<u>K</u>	3
2. W	♠ 6	9	<u>J</u>	2
3. E	♥ J	<u>♦ 6</u>	4	8
4. S	♣ Q	<u>A</u>	2	3
5. W	♣ 10	<u>K</u>	7	4
6. N	♥ 7	9	<u>♦ 9</u>	5
7. S	<u>♦ A</u>	5	7	3
8. S	<u>♦ J</u>	10	8	2
9. S	♠ 4	Q	<u>A</u>	3

Made 4 — NS +130

**Board 743**  
 West Deals  
 Both Vul

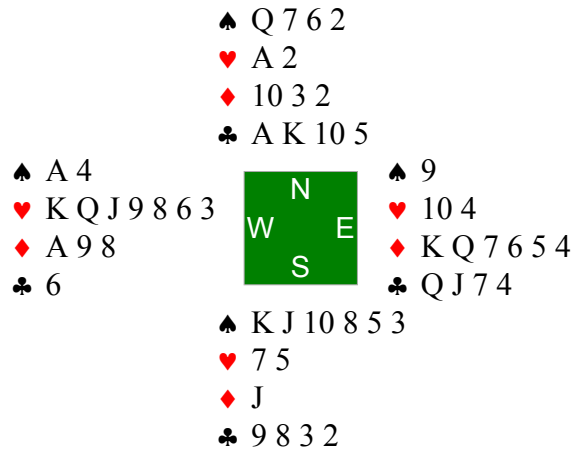

EW 4♥; EW 5♦; N 3♠; S 2♠; EW 1N; NS 2♣; Par -500: N 5♠×-2

West	North	East	South
<i>EdoWell</i>	<i>smispi</i>	<i>Harmon</i>	<i>jec</i>
1 ♥	Dbl	Pass	3 ♠
4 ♥	4 ♠	4 NT	Pass
5 ♥	Pass	Pass	Pass

5 ♥ by West

<i>Trick</i>	<i>Lead</i>	<i>2nd</i>	<i>3rd</i>	<i>4th</i>
1. N	♣ A	4	2	6
2. N	♦ 2	5	J	<u>A</u>
3. W	♥ Q	<u>A</u>	4	5
4. N	♦ 3	Q	<u>♥ 7</u>	8
5. S	♣ 3	-	-	-

Down 1 — NS +100

**Board 747**  
 West Deals  
 None Vul

♠ A K 8 6 4	♠ J 9 5 3 2	♠ 10 7
♥ 8 6 3	♥ 9 4	♥ A Q J 7 5 2
♦ A 8 2	♦ K Q J 7	♦ 6 5
♣ 8 2	♣ 10 3	♣ J 5 4

♠ Q
♥ K 10
♦ 10 9 4 3
♣ A K Q 9 7 6

NS 4♦; NS 4♣; EW 2♥; NS 1N; NS 1♠; Par +130

West	North	East	South
<i>EdoWell</i>	<i>smispi</i>	<i>Harmon</i>	<i>jec</i>
1 ♠	Pass	1 NT	3 ♣
Pass	Pass	3 ♥	Pass
Pass	Pass		

3 ♥ by East

<i>Trick</i>	<i>Lead</i>	<i>2nd</i>	<i>3rd</i>	<i>4th</i>
1. S	<u>♣ A</u>	2	10	4
2. S	<u>♣ K</u>	8	3	5
3. S	♣ Q	♥ 6	<u>♥ 9</u>	J
4. N	♦ K	5	4	<u>A</u>
5. W	♥ 3	4	Q	<u>K</u>
6. S	♦ 3	2	<u>J</u>	6
7. N	♦ Q	<u>♥ J</u>	9	8
8. E	<u>♥ A</u>	10	8	♦ 7

Down 1 — NS +50

**Board 749**  
 East Deals  
 Both Vul

♠ K 10	♠ 9 6 4 3	♠ J 5 2
♥ K 7 2	♥ A Q 8	♥ J 6 3
♦ A Q 9 8 3 2	♦ K 4	♦ 7 6
♣ J 8	♣ A 9 7 5	♣ K 10 6 4 3

N	
W	E
S	

♠ A Q 8 7
♥ 10 9 5 4
♦ J 10 5
♣ Q 2

NS 3♠; NS 2♥; NS 1N; EW 2♦; NS 1♣; Par +140

West	North	East	South
<i>EdoWell</i>	<i>smispi</i>	<i>Harmon</i>	<i>jec</i>
		Pass	Pass
1♦	Dbl	Pass	1♠
Pass	Pass	Pass	

1♠ by South

<i>Trick</i>	<i>Lead</i>	<i>2nd</i>	<i>3rd</i>	<i>4th</i>
1. W	♣ J	5	<u>K</u>	2
2. E	♥ 3	4	K	<u>A</u>
3. N	♠ 3	2	Q	<u>K</u>
4. W	♥ 7	<u>Q</u>	6	5
5. N	♠ 4	5	<u>A</u>	10
6. S	♣ <u>Q</u>	8	7	3
7. S	♥ 10	2	8	<u>J</u>
8. E	<u>♠ J</u>	7	♦ 3	6
9. E	♦ 7	5	<u>A</u>	4
10. W	♦ 2	-	-	-

Made 2 — NS +110



**Board 750**  
 South Deals  
 None Vul

<p>♠ K Q 4          ♥ J 9 2          ♦ J 7          ♣ A K Q 10 3</p>		<p>♠ 10 9 8 2          ♥ A 10 7 3          ♦ K 9 8 6 4          ♣ —</p>	<p>♠ J 6 5 3          ♥ 6 5          ♦ A Q 10 5 2          ♣ 9 6</p>
<p>♠ A 7          ♥ K Q 8 4          ♦ 3          ♣ J 8 7 5 4 2</p>			

EW 2N; NS 2♥; EW 2♦; EW 1♠; EW 1♣; Par -100; NS 3♥×-1

West	North	East	South
<i>EdoWell</i>	<i>smispi</i>	<i>Harmon</i>	<i>jec</i>
			Pass
1 NT	Pass	Pass	2 NT <sup>1</sup>
Pass	3 ♥	Dbl	Pass
Pass	Pass		

1. 4h longer minor

3 ♥× by North

<i>Trick</i>	<i>Lead</i>	<i>2nd</i>	<i>3rd</i>	<i>4th</i>
1. E	♥ 5	<u>K</u>	2	3
2. S	♦ 3	J	K	<u>A</u>
3. E	♥ 6	4	9	<u>10</u>
4. N	<u>♦ 8</u>	2	♠ 7	7
5. N	♠ 2	3	<u>A</u>	4
6. S	♣ 2	3	<u>♥ 7</u>	6
7. N	♠ 8	5	<u>♥ 8</u>	Q
8. S	♣ 4	10	<u>♥ A</u>	9
9. N	♦ 6	10	<u>♥ Q</u>	♣ A

Down 1 — NS -100

**Board 751**  
 West Deals  
 N-S Vul

♠ Q 10 4 ♥ A J 8 6 2 ♦ 2 ♣ Q 10 9 6		♠ K J 9 6 5 ♥ K ♦ 9 8 6 3 ♣ 8 7 4	♠ 3 2 ♥ 10 9 4 3 ♦ A K 10 7 5 ♣ A 2
		♠ A 8 7 ♥ Q 7 5 ♦ Q J 4 ♣ K J 5 3	

EW 3♥; NS 1♠; EW 1♦; Par -140

West	North	East	South
<i>EdoWell</i>	<i>smispi</i>	<i>Harmon</i>	<i>jec</i>
Pass	Pass	1♦	Dbl
1♥	2♠	3♥	Pass
Pass	3♠	Pass	Pass
Dbl <sup>1</sup>	Pass	Pass	Pass

1. take out

3♠× by North

Trick	Lead	2nd	3rd	4th
1. E	♦ <u>A</u>	4	2	8
2. E	♥ 10	5	<u>A</u>	K
3. W	♣ 10	4	<u>A</u>	3
4. E	♦ <u>K</u>	J	♥ 2	3
5. E	♦ 7	Q	♠ <u>10</u>	6
6. W	♥ 8	♣ 8	3	<u>Q</u>
7. S	♠ <u>A</u>	4	5	2
8. S	♠ 7	Q	<u>K</u>	3

Down 1 — NS -200

**Board 755**  
 West Deals  
 Both Vul

♠ 8 6	♠ A K Q 7	♠ 9 4
♥ K 4 3	♥ 9 6	♥ A Q 10 8 5
♦ A K 6 5	♦ Q 8 3 2	♦ J 10 9 4
♣ A Q 9 6	♣ K 10 7	♣ J 5

♠ J 10 5 3 2
♥ J 7 2
♦ 7
♣ 8 4 3 2

EW 4♥; EW 2N; NS 2♠; EW 3♦; EW 2♣; Par -500; NS 4♠×-2

West	North	East	South
<i>saket92</i>	<i>BridgeGoth</i>	<i>error1990</i>	<i>jec</i>
1 NT	Pass	2 ♦	Pass
2 ♥	Dbl	Pass	2 ♠
Pass	Pass	3 ♦	3 ♠
4 ♥	Pass	Pass	Pass

4 ♥ by West

<i>Trick</i>	<i>Lead</i>	<i>2nd</i>	<i>3rd</i>	<i>4th</i>
1. N	<u>♠ A</u>	4	2	6
2. N	<u>♠ K</u>	9	J	8
3. N	♥ 6	<u>A</u>	2	3
4. E	♥ 5	7	<u>K</u>	9
5. W	<u>♦ A</u>	2	4	7
6. W	♦ K	3	9	<u>♥ J</u>
7. S	♣ 8	6	<u>K</u>	5
8. N	<u>♦ Q</u>	10	♣ 2	5
9. N	♦ 8	<u>J</u>	♣ 3	6

Down 2 — NS +200

**Board 763**  
 West Deals  
 N-S Vul

♠ A 10 6 4 ♥ J ♦ A J 10 6 5 ♣ A 5 3		♠ Q 7 ♥ 9 8 7 6 2 ♦ 3 ♣ J 10 9 8 2	♠ 9 5 3 ♥ Q 10 5 4 ♦ K 9 7 4 ♣ K 4
♠ K J 8 2 ♥ A K 3 ♦ Q 8 2 ♣ Q 7 6			

EW 3♠; EW 4♦; EW 2N; NS 1♣; Par -140

West	North	East	South
<i>saket92</i>	<i>BridgeGoth</i>	<i>error1990</i>	<i>jec</i>
1 ♦	Pass	1 ♥	1 NT
Pass	Pass	2 ♦	Pass
Pass	Pass		

2 ♦ by West

<i>Trick</i>	<i>Lead</i>	<i>2nd</i>	<i>3rd</i>	<i>4th</i>
1. N	♣ J	4	6	<u>A</u>
2. W	♦ 5	3	<u>K</u>	2
3. E	♦ 4	8	<u>10</u>	♥ 2
4. W	♦ A	♣ 2	7	Q
5. W	♥ J	6	4	<u>A</u>
6. S	♠ K	4	7	3
7. S	♠ 2	<u>A</u>	Q	5
8. W	♣ 3	8	<u>K</u>	7
9. E	♥ 10	K	♦ J	7
10. W	♣ 5	9	♦ 9	Q
11. E	♥ Q	3	♠ 10	8
12. E	♥ 5	♠ 8	♠ 6	<u>9</u>
13. N	♣ 10	♠ 9	♠ J	-

Made 4 — NS -130

**Board 764**  
 North Deals  
 Both Vul

♠ 7 4 ♥ A K 8 6 4 ♦ K 10 8 ♣ K 9 3		♠ 10 6 ♥ Q 5 ♦ Q J 9 7 2 ♣ J 5 4 2	♠ 8 5 2 ♥ J 10 2 ♦ A 6 5 ♣ A Q 10 7
---	---	---	--

♠ A K Q J 9 3  
 ♥ 9 7 3  
 ♦ 4 3  
 ♣ 8 6

EW 4♥; EW 5♣; EW 1N; EW 2♦; Par -620

West	North	East	South
<i>saket92</i>	<i>llorenzo</i>	<i>error1990</i>	<i>jec</i>
	Pass	1 ♣	1 ♠
2 ♥	Pass	3 ♥	Pass
4 ♥	Pass	Pass	Pass

4 ♥ by West

<i>Trick</i>	<i>Lead</i>	<i>2nd</i>	<i>3rd</i>	<i>4th</i>
1. N	♠ 10	2	<u>J</u>	4
2. S	♠ <u>A</u>	7	6	5
3. S	♠ 9	♥ 8	♥ <u>Q</u>	8
4. N	♦ Q	<u>A</u>	4	8
5. E	♥ <u>J</u>	3	4	5
6. E	♥ 2	7	<u>A</u>	♦ 2
7. W	♥ <u>K</u>	♦ 7	10	9
8. W	♥ <u>6</u>	♦ 9	♦ 5	♠ Q
9. W	♣ 3	2	<u>A</u>	6
10. E	♣ 7	8	<u>K</u>	4
11. W	♣ 9	5	<u>Q</u>	♠ 3
12. E	♦ 6	3	<u>K</u>	J
13. W	♦ <u>10</u>	♣ J	♣ 10	♠ K

Made 4 — NS -620

**Board 768**  
 North Deals  
 None Vul

♠ K J 8 5 3 ♥ 6 ♦ 10 8 7 ♣ J 9 7 6		♠ Q 10 7 6 4 ♥ A 10 9 5 3 ♦ 3 ♣ 8 5	♠ A ♥ K J ♦ K J 9 5 ♣ A K Q 4 3 2
		♠ 9 2 ♥ Q 8 7 4 2 ♦ A Q 6 4 2 ♣ 10	

EW 3N; NS 3♥; EW 3♣; EW 2♦; Par -100; NS 4♥×-1

West	North	East	South
<i>saket92</i>	<i>llorenzo</i>	<i>error1990</i>	<i>jec</i>
	Pass	1 ♣	2 NT
Pass	4 ♣ <sup>1</sup>	Dbl	Pass
Pass	4 ♥	Dbl	Pass
Pass	Pass		

1. I D KNOW

4 ♥× by North

<i>Trick</i>	<i>Lead</i>	<i>2nd</i>	<i>3rd</i>	<i>4th</i>
1. E	<u>♠ A</u>	2	8	4
2. E	<u>♣ A</u>	10	9	5
3. E	<u>♣ K</u>	<u>♥ 2</u>	6	8
4. S	<u>♦ A</u>	7	3	5
5. S	♦ 2	8	<u>♥ 3</u>	9
6. N	<u>♥ A</u>	J	4	6
7. N	♥ 5	<u>K</u>	7	♠ 3
8. E	♣ 2	♠ 9	7	<u>♥ 9</u>
9. N	♠ 6	♣ 3	<u>♥ 8</u>	5
10. S	♦ 4	10	<u>♥ 10</u>	J

Down 2 — NS -300

**Board 771**  
 West Deals  
 Both Vul

♠ 7 ♥ A K 10 8 ♦ J 10 8 7 ♣ 7 6 4 3	♠ 10 6 4 ♥ 6 4 3 2 ♦ A Q 5 4 ♣ J 2		♠ K Q J 8 5 2 ♥ 9 5 ♦ 3 2 ♣ A 10 5
♠ A 9 3 ♥ Q J 7 ♦ K 9 6 ♣ K Q 9 8			

EW 1♠; Par -80

West	North	East	South
<i>saket92</i>	<i>llorenzo</i>	<i>error1990</i>	<i>jec</i>
Pass	Pass	1 ♠	Dbl
Pass	2 ♥	2 ♠	Pass
Pass	Pass		

2 ♠ by East

<i>Trick</i>	<i>Lead</i>	<i>2nd</i>	<i>3rd</i>	<i>4th</i>
1. S	♥ Q	<u>A</u>	6	5
2. W	♠ 7	4	K	<u>A</u>
3. S	♥ 7	<u>K</u>	2	9
4. W	♣ 3	2	<u>A</u>	9
5. E	<u>♠ Q</u>	3	♣ 4	6
6. E	<u>♠ J</u>	9	♣ 6	10

Made 2 — NS -110

**Board 773**  
 East Deals  
 E-W Vul

♠ K 5		♠ A 8 7 2
♥ A K 8 7 6 2		♥ 10 5
♦ K 9 8 2		♦ A 7
♣ 5		♣ A J 10 7 2
	<div style="display: inline-block; background-color: #006400; color: white; padding: 5px; border: 1px solid black;">           N            W     E            S         </div>	♠ J 9 6 4 3
		♥ Q
		♦ J 6
		♣ Q 8 6 4 3
		♠ Q 10
		♥ J 9 4 3
		♦ Q 10 5 4 3
		♣ K 9

NS 2N; NS 2♦; NS 1♠; EW 1♥; NS 1♣; Par +120

West	North	East	South
<i>saket92</i>	<i>llorenzo</i>	<i>error1990</i>	<i>jec</i>
		Pass	Pass
1 ♥	Dbl	Pass	2 ♦
2 ♥	Pass	Pass	Pass

2 ♥ by West

Trick	Lead	2nd	3rd	4th
1. N	♥ 5	Q	3	2
2. E	♦ 6	5	8	<u>A</u>
3. N	♦ 7	J	Q	<u>K</u>
4. W	♣ 5	2	8	<u>9</u>
5. S	<u>♦ 10</u>	2	♠ 2	♠ 3
6. S	♦ 3	9	<u>♥ 10</u>	♠ 4
7. N	♣ 7	Q	K	<u>♥ 6</u>
8. W	<u>♥ A</u>	♠ 7	♣ 3	4
9. W	♠ K	<u>A</u>	6	10
10. N	♠ 8	9	Q	5
11. S	♦ 4	<u>♥ 7</u>	♣ 10	♣ 4
12. W	<u>♥ K</u>	♣ J	♣ 6	9
13. W	♥ 8	♣ A	♠ J	<u>J</u>

Down 2 — NS +200



**Board 774**  
 South Deals  
 Both Vul

♠ K 7 3 ♥ A Q 9 8 7 ♦ Q 9 5 ♣ K 5	<div style="background-color: green; color: white; padding: 5px; display: inline-block;">           N            W     E            S         </div>	♠ A 10 6 2 ♥ K 3 ♦ A 10 6 3 ♣ A J 7	♠ Q J 9 ♥ — ♦ K J 8 7 4 2 ♣ Q 8 6 2
		♠ 8 5 4 ♥ J 10 6 5 4 2 ♦ — ♣ 10 9 4 3	

EW 4♦; EW 2N; NS 1♠; NS 1♥; EW 1♣; Par -130

West	North	East	South
<i>saket92</i>	<i>llorenzo</i>	<i>error1990</i>	<i>jec</i>
			Pass
1 NT	Dbl <sup>1</sup>	Pass	2♥
Pass	Pass	5♦	Pass
Pass	Dbl	Pass	Pass
Pass			

1. POINTS

5♦ × by East

Trick	Lead	2nd	3rd	4th
1. S	♥ J	<u>A</u>	3	♣ 2
2. W	♣ K	<u>A</u>	6	4
3. N	♣ 7	<u>Q</u>	3	5
4. E	♣ 8	9	<u>♦ 5</u>	J
5. W	♦ Q	<u>A</u>	2	♥ 2
6. N	♥ K	<u>♦ 4</u>	4	7
7. E	♠ J	4	3	2
8. E	<u>♠ Q</u>	5	7	6
9. E	♠ 9	8	K	<u>A</u>
10. N	♠ 10	♦ 7	♥ 5	<u>♦ 9</u>
11. W	♥ 8	♦ 3	<u>♦ 8</u>	10
12. E	♦ K	♥ 6	-	-

Down 1 — NS +200

**Board 775**  
 West Deals  
 None Vul

♠ Q J 9 7 5 ♥ 7 5 4 ♦ K 10 7 ♣ 10 2		♠ A 10 6 4 3 ♥ J 6 ♦ J 2 ♣ A 9 8 7	♠ — ♥ K 10 3 2 ♦ 5 4 ♣ K Q J 6 5 4 3
		♠ K 8 2 ♥ A Q 9 8 ♦ A Q 9 8 6 3 ♣ —	

NS 5N; S 5♠; N 4♠; NS 5♦; NS 3♥; EW 1♣; Par +460

West	North	East	South
<i>saket92</i>	<i>llorenzo</i>	<i>error1990</i>	<i>jec</i>
Pass	Pass	1 ♣	1 ♦
1 ♠	Dbl <sup>1</sup>	2 ♣	4 ♥
Pass	5 ♦	Dbl	Pass
Pass	Pass		

1. NEGAT D

5 ♦ × by South

<i>Trick</i>	<i>Lead</i>	<i>2nd</i>	<i>3rd</i>	<i>4th</i>
1. W	♠ Q	3	<u>♦ 5</u>	2
2. E	♥ 2	8	4	<u>J</u>
3. N	♦ J	4	3	<u>K</u>
4. W	♠ 5	4	♣ 3	<u>K</u>
5. S	♠ 8	9	<u>10</u>	♣ 4
6. N	<u>♠ A</u>	♣ 5	♥ 9	7
7. N	<u>♣ A</u>	6	♥ Q	2
8. N	♦ 2	♣ J	<u>A</u>	7
9. S	♦ Q	10	-	-

Made 5 — NS +550

**Board 776**  
 North Deals  
 E-W Vul

♠ 10 6 4 ♥ Q J 8 7 6 ♦ J 10 2 ♣ Q 2		♠ Q 8 3 2 ♥ 10 3 ♦ 8 3 ♣ A J 6 5 3	♠ A J 9 7 5 ♥ 9 5 ♦ A Q 5 4 ♣ 10 7
♠ K ♥ A K 4 2 ♦ K 9 7 6 ♣ K 9 8 4			

NS 5♣; NS 2N; NS 1♥; NS 1♦; Par +400

West	North	East	South
<i>saket92</i>	<i>llorenzo</i>	<i>error1990</i>	<i>jec</i>
	Pass	1 ♠	Dbl
2 ♠	3 ♣	3 ♠	4 ♣
Pass	Pass	Pass	

4 ♣ by North

<i>Trick</i>	<i>Lead</i>	<i>2nd</i>	<i>3rd</i>	<i>4th</i>
1. E	♥ 9	<u>A</u>	8	3
2. S	♠ K	4	2	<u>A</u>
3. E	♥ 5	<u>K</u>	6	10
4. S	♣ K	2	3	7
5. S	♣ 4	Q	<u>A</u>	10
6. N	♦ 3	4	<u>K</u>	2

Made 5 — NS +150

**Board 779**  
West Deals  
N-S Vul

♠ K 10 6	♠ Q 9 3	♠ A J 8 7 4
♥ 7 6 5 4	♥ Q 9	♥ K 8 2
♦ 10 9 6 3	♦ J 5 4 2	♦ —
♣ 5 4	♣ K Q 8 6	♣ A 10 7 3 2

N	
W	E
S	

♠ 5 2
♥ A J 10 3
♦ A K Q 8 7
♣ J 9

NS 4♦; EW 2♠; NS 1N; NS 1♥; Par +130

West	North	East	South
<i>saket92</i>	<i>llorenzo</i>	<i>error1990</i>	<i>jec</i>
Pass	Pass	1 ♠	Dbl
2 ♠	Dbl	3 ♠	Dbl
Pass	3 NT	Dbl	4 ♦
Pass	Pass	Dbl	Pass
Pass	Pass		

4♦× by South

<i>Trick</i>	<i>Lead</i>	<i>2nd</i>	<i>3rd</i>	<i>4th</i>
1. W	♠ <u>K</u>	3	8	2
2. W	♠ 10	Q	<u>A</u>	5
3. E	♠ J	<u>♦ 8</u>	6	9
4. S	♣ 9	5	Q	<u>A</u>
5. E	♣ 2	<u>J</u>	4	6
6. S	<u>♦ A</u>	3	2	♣ 3
7. S	♦ 7	6	<u>J</u>	♠ 4
8. N	♥ Q	K	<u>A</u>	4
9. S	♥ 3	5	<u>9</u>	2

Made 4 — NS +710

**Board 780**  
 North Deals  
 None Vul

♠ 2	♠ 8 5 4	♠ A 10 3
♥ A 7 4 2	♥ Q 10 9 8	♥ K J 6 5
♦ Q 6 4	♦ A K 3 2	♦ J 9 8 7 5
♣ 9 6 5 4 2	♣ 10 3	♣ A

♠ K Q J 9 7 6
♥ 3
♦ 10
♣ K Q J 8 7

NS 3♠; EW 3♥; NS 1N; EW 2♦; NS 1♣; Par +100; EW 4♥×-1

West	North	East	South
<i>Harmon</i>	<i>nevaio</i>	<i>weedo</i>	<i>jec</i>
	Pass	1♦	1♠
Dbl	2♦	2♥	4♠
Pass	Pass	Pass	

4♠ by South

<i>Trick</i>	<i>Lead</i>	<i>2nd</i>	<i>3rd</i>	<i>4th</i>
1. W	♦ 4	<u>K</u>	5	10
2. N	<u>♦ A</u>	7	♥ 3	6
3. N	♠ 4	<u>A</u>	6	2
4. E	<u>♣ A</u>	7	2	3
5. E	♥ 5	<u>♠ 7</u>	7	8

Made 5 — NS +450

**Board 786**  
 South Deals  
 Both Vul

♠ K Q 10 4 2	♠ 9 7	♠ 6
♥ J 9 6	♥ 10 8 7 5 4 2	♥ A
♦ K 2	♦ J	♦ A Q 10 9 7 6 4
♣ Q 10 2	♣ A K 9 4	♣ J 7 6 3

♠ A J 8 5 3
♥ K Q 3
♦ 8 5 3
♣ 8 5

EW 2N; NS 2♥; EW 3♦; EW 1♣; Par -120

West	North	East	South
<i>Harmon</i>	<i>nevaio</i>	<i>weedo</i>	<i>jec</i>
Pass	Pass	3♦	Pass
Pass	3♥	Pass	Pass
Pass			

3♥ by North

<i>Trick</i>	<i>Lead</i>	<i>2nd</i>	<i>3rd</i>	<i>4th</i>
1. E	♦ <u>A</u>	3	2	J
2. E	♦ 9	5	K	♥ <u>2</u>
3. N	♠ 7	6	3	<u>10</u>
4. W	♣ 2	<u>A</u>	7	5
5. N	♥ 4	<u>A</u>	3	6
6. E	♦ Q	8	♥ <u>J</u>	♠ 9
7. W	♠ 2	♥ <u>10</u>	♦ 4	5
8. N	♥ 5	♦ 6	Q	9

Made 3 — NS +140

**Board 787**  
 West Deals  
 None Vul

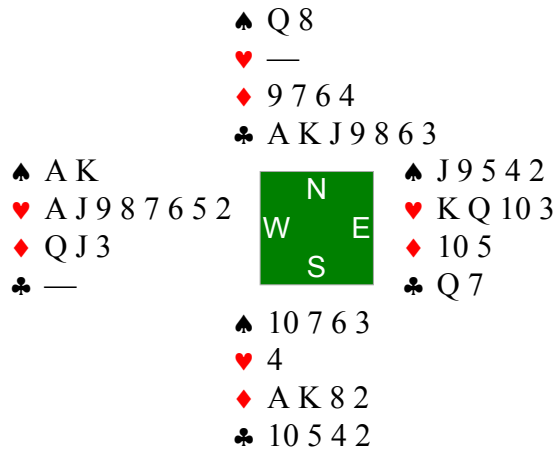

EW 5♥; NS 4♦; NS 4♣; EW 1♠; Par -300: NS 6♣×-2; NS 6♦×-2

West	North	East	South
<i>Harmon</i>	<i>nevaio</i>	<i>weedo</i>	<i>jec</i>
1♥	4♣	4♥	4NT
5♣	5♦	5♥	Pass
Pass	5NT	Pass	6♣
6♥	Pass	Pass	Pass

6♥ by West

Trick	Lead	2nd	3rd	4th
1. N	♦ 6	5	<u>K</u>	3
2. S	♦ <u>A</u>	J	4	10
3. S	♣ 2	-	-	-

Down 1 — NS +50

**Board 789**  
 East Deals  
 Both Vul

<p>♠ 7 3 2          ♥ K 10 9 6          ♦ A 2          ♣ 10 4 3 2</p>	<p>♠ J 9          ♥ 5          ♦ K Q J 9 6 3          ♣ A J 9 5</p>	<div style="text-align: center; border: 1px solid black; width: 40px; height: 40px; margin: 0 auto; background-color: green; color: white; display: flex; flex-direction: column; align-items: center; justify-content: center;"> <span>N</span> <span>W</span> <span>E</span> <span>S</span> </div>	<p>♠ K 8 6 5 4          ♥ A Q J          ♦ 5 4          ♣ K 7 6</p>
<p>♠ A Q 10          ♥ 8 7 4 3 2          ♦ 10 8 7          ♣ Q 8</p>			

NS 4♦; NS 1N; EW 1♠; NS 1♣; Par +130

West	North	East	South
<i>Harmon</i>	<i>nevaio</i>	<i>weedo</i>	<i>jec</i>
		1 ♠	Pass
2 ♠	3 ♦	3 ♠	4 ♦
Pass	Pass	Pass	

4 ♦ by North

<i>Trick</i>	<i>Lead</i>	<i>2nd</i>	<i>3rd</i>	<i>4th</i>
1. E	♦ 5	7	<u>A</u>	3
2. W	♥ K	5	<u>A</u>	2
3. E	♥ J	3	6	<u>♦ 6</u>
4. N	♦ 9	4	8	2
5. N	♠ J	4	10	2

Made 4 — NS +130



**Board 795**  
 West Deals  
 E-W Vul

♠ J 9 6 4 3		♠ 8
♥ K 9 4		♥ 8
♦ 9		♦ 10 8 6 5 4 3
♣ J 8 5 4		♣ A Q 10 9 3
♠ Q 10 7 5 2	<div style="display: inline-block; background-color: green; color: white; padding: 5px; border: 1px solid black;">           N            W      E            S         </div>	
♥ A 10 7 6		
♦ A		
♣ K 6 2		
♠ A K		
♥ Q J 5 3 2		
♦ K Q J 7 2		
♣ 7		

NS 3♥; EW 3♣; EW 1N; EW 2♦; Par +140

West	North	East	South
<i>Harmon</i>	<i>nevaio</i>	<i>weedo</i>	<i>jec</i>
1 ♠	Pass	1 NT	2 ♦ <sup>1</sup>
Pass	2 ♥	3 ♣	Dbl
Rdbl	4 ♥	Pass	Pass
5 ♣	Dbl	Pass	Pass
Pass			

1. d+h

5 ♣× by East

<i>Trick</i>	<i>Lead</i>	<i>2nd</i>	<i>3rd</i>	<i>4th</i>
1. S	♦ K	<u>A</u>	9	3
2. W	<u>♥ A</u>	4	8	2
3. W	♥ 6	K	<u>♣ 3</u>	3
4. E	♦ 4	2	♣ 2	<u>♣ 4</u>
5. N	♣ 5	<u>9</u>	7	6
6. E	♦ 5	7	<u>♣ K</u>	♠ 3
7. W	♥ 7	9	<u>♣ 10</u>	Q

Down 3 — NS +800

**Board 799**  
 West Deals  
 Both Vul

♠ —	♠ K 8 7 5	♠ Q 10 9 6
♥ A K 9 6	♥ Q 10 8 5	♥ J 4 3
♦ A J 6 5	♦ 10 7 3	♦ Q 9 4 2
♣ A Q 10 9 2	♣ 4 3	♣ 6 5

N	
W	E
S	

♠ A J 4 3 2
♥ 7 2
♦ K 8
♣ K J 8 7

EW 3N; EW 5♦; EW 3♥; EW 3♣; EW 1♠; Par -600

West	North	East	South
<i>Harmon</i>	<i>nevaio</i>	<i>weedo</i>	<i>jec</i>
1 ♣	Pass	1 ♦	1 ♠
2 ♠	3 ♠	Pass	Pass
6 ♦	Pass	Pass	Pass

6 ♦ by East

<i>Trick</i>	<i>Lead</i>	<i>2nd</i>	<i>3rd</i>	<i>4th</i>
1. S	♥ 7	6	<u>Q</u>	3
2. N	♥ 5	<u>J</u>	2	9
3. E	♦ 2	8	<u>J</u>	3
4. W	♦ <u>A</u>	7	4	K
5. W	♦ 5	10	<u>Q</u>	♠ 2
6. E	♣ 6	7	<u>Q</u>	3
7. W	♣ <u>A</u>	4	5	8
8. W	♣ 2	♠ 7	<u>♦ 9</u>	J
9. E	♥ 4	♠ 4	<u>K</u>	8

Down 1 — NS +100

**Board 807**  
 West Deals  
 N-S Vul

♠ A K 10 9	<div style="display: inline-block; background-color: green; color: white; padding: 10px; border: 1px solid black;">           N W     E S         </div>	♠ 6 4 2
♥ K 7		♥ 8 5 4
♦ Q 3		♦ J 8 4 2
♣ K Q J 3 2		♣ A 10 6
	♠ Q J 8	
	♥ A J 3	
	♦ A K 10 9 7	
	♣ 8 5	

EW 4N; EW 3♠; EW 4♣; NS 1♥; EW 1♦; Par -430

West	North	East	South
<i>Harmon</i>	<i>nevaio</i>	<i>ckv</i>	<i>jec</i>
1 ♣	Pass	Pass	Dbl
Rdbl	1 ♥	2 ♣	2 ♦
2 ♠	Pass	3 ♣	Pass
Pass	Pass		

3 ♣ by West

<i>Trick</i>	<i>Lead</i>	<i>2nd</i>	<i>3rd</i>	<i>4th</i>
1. N	♦ 6	2	<u>K</u>	3
2. S	<u>A</u>	Q	5	4
3. S	♦ 7	♠ 9	<u>♣ 4</u>	8
4. N	♥ 2	4	<u>A</u>	7
5. S	♦ 9	<u>♣ K</u>	♠ 3	J
6. W	<u>♣ Q</u>	7	6	5
7. W	♣ 2	9	<u>10</u>	8
8. E	♠ 2	8	<u>10</u>	5

Made 3 — NS -110

**Board 811**  
 West Deals  
 Both Vul

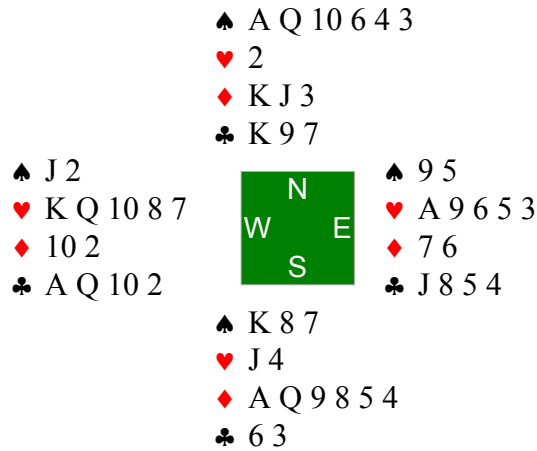

NS 5♠; NS 5♦; EW 2♥; NS 1N; EW 1♣; Par +650

West	North	East	South
<i>morales1</i>	<i>smispi</i>	<i>woozle</i>	<i>jec</i>
1 ♥	1 ♠	4 ♥	4 ♠
Pass	Pass	Pass	

4 ♠ by North

Trick	Lead	2nd	3rd	4th
1. E	♥ <u>A</u>	4	7	2
2. E	♣ 4	3	<u>A</u>	7
3. W	♥ Q	♠ <u>3</u>	3	J
4. N	♠ <u>A</u>	5	7	2

Made 5 — NS +650

**Board 815**  
 West Deals  
 None Vul

♠ K 10 7	♠ A 9 5 3	♠ Q J
♥ 9 2	♥ Q 10 8 7 3	♥ A 5
♦ J 7 5 3	♦ 10 4	♦ K Q 9 6
♣ J 8 7 4	♣ 10 2	♣ Q 9 6 5 3

♠ 8 6 4 2
♥ K J 6 4
♦ A 8 2
♣ A K

NS 3♠; NS 3♥; NS 2N; EW 2♦; EW 1♣; Par +140

West	North	East	South
<i>moraes1</i>	<i>smispi</i>	<i>woozle</i>	<i>jec</i>
Pass	Pass	1♦	Dbl
Pass	1♥	Pass	Pass
2♦	Dbl	Pass	2♥
Pass	Pass	Pass	

2♥ by North

<i>Trick</i>	<i>Lead</i>	<i>2nd</i>	<i>3rd</i>	<i>4th</i>
1. E	♦ <u>K</u>	2	3	4
2. E	♦ Q	<u>A</u>	7	10
3. S	♥ 4	2	Q	<u>A</u>
4. E	♥ 5	<u>J</u>	9	7
5. S	♦ 8	J	<u>♥ 8</u>	6
6. N	♣ 2	6	<u>K</u>	4
7. S	<u>♣ A</u>	7	10	3
8. S	♠ 2	10	5	<u>J</u>
9. E	♠ Q	-	-	-

Made 3 — NS +140

**Board 819**  
 West Deals  
 N-S Vul

♠ J 9 ♥ K Q J 6 ♦ 9 5 4 ♣ K Q J 2		♠ 5 4 3 ♥ 9 7 3 ♦ K 6 2 ♣ A 9 8 5	♠ A K 6 ♥ 10 8 ♦ J 8 7 3 ♣ 10 7 4 3
		♠ Q 10 8 7 2 ♥ A 5 4 2 ♦ A Q 10 ♣ 6	

NS 2♠; EW 2♣; NS 1♥; EW 1♦; Par +100; EW 3♣×-1

West	North	East	South
<i>morales1</i>	<i>smispi</i>	<i>woozle</i>	<i>jec</i>
1 ♣	Pass	1 NT	Dbl
Pass	2 ♣	Pass	2 ♠
Pass	Pass	Pass	

2 ♠ by South

<i>Trick</i>	<i>Lead</i>	<i>2nd</i>	<i>3rd</i>	<i>4th</i>
1. W	♣ K	<u>A</u>	3	6
2. N	♠ 3	6	8	<u>9</u>
3. W	♠ J	4	<u>K</u>	2
4. E	♠ A	7	♦ 9	5
5. E	♣ 4	♠ 10	Q	5
6. S	♥ 2	<u>J</u>	3	8
7. W	♣ J	8	7	♠ Q
8. S	♥ A	6	7	10
9. S	♥ 4	<u>Q</u>	9	♦ 7
10. W	♥ K	♣ 9	♦ 3	5
11. W	♣ 2	♦ 2	<u>10</u>	♦ 10
12. E	♦ 8	-	-	-

Down 2 — NS -200

**Board 825**  
 East Deals  
 N-S Vul

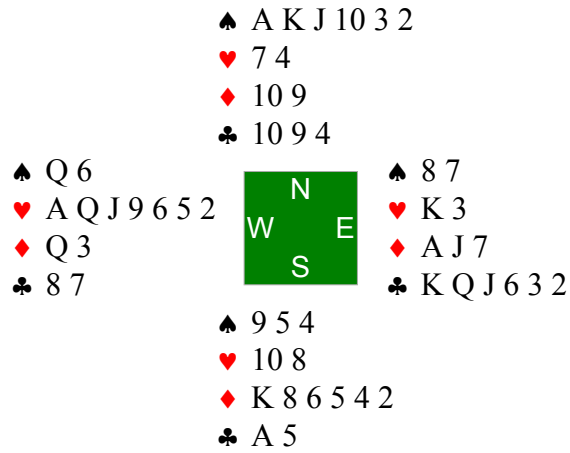

NS 3♠; EW 3♥; EW 2♣; NS 1♦; Par +100; EW 4♥×-1

West	North	East	South
<i>morales1</i>	<i>smispi</i>	<i>woozle</i>	<i>jec</i>
		1 NT	Pass
2♦ <sup>1</sup>	2♠	Pass	3♠
4♥	Pass	Pass	Pass

1. tx

4♥ by West

<i>Trick</i>	<i>Lead</i>	<i>2nd</i>	<i>3rd</i>	<i>4th</i>
1. N	<u>♠ A</u>	7	4	6
2. N	<u>♠ K</u>	8	9	Q
3. N	<u>♦ 10</u>	7	<u>K</u>	Q
4. S	<u>♣ A</u>	8	4	2
5. S	<u>♣ 5</u>	7	9	<u>K</u>
6. E	<u>♥ K</u>	8	2	4
7. E	<u>♥ 3</u>	10	-	-

Down 1 — NS +50

**Board 827**  
 West Deals  
 Both Vul

♠ 7	♠ Q 9	♠ K J 10 5 4 2
♥ 4 3 2	♥ Q 7	♥ 9 8 6
♦ Q 8 7 4 3	♦ J 10 6 2	♦ 9 5
♣ K 8 4 3	♣ J 10 9 6 5	♣ Q 7

N
W    E
S

♠ A 8 6 3
♥ A K J 10 5
♦ A K
♣ A 2

NS 4N; NS 4♥; NS 5♣; NS 3♠; NS 4♦; Par +630

West	North	East	South
<i>morales1</i>	<i>smispi</i>	<i>woozle</i>	<i>jec</i>
Pass	Pass	1 ♠	Dbl
Pass	2 ♣	Pass	2 ♥
Pass	2 NT	Pass	3 NT
Pass	Pass	Pass	

3 NT by North

Trick	Lead	2nd	3rd	4th
1. E	♦ 9	<u>K</u>	3	6
2. S	♣ 2	3	9	<u>Q</u>
3. E	♣ 7	<u>A</u>	4	5
4. S	♦ <u>A</u>	4	2	5
5. S	♥ 5	4	<u>Q</u>	9
6. N	♠ Q	K	<u>A</u>	7
7. S	♥ <u>A</u>	2	7	6
8. S	♥ <u>K</u>	3	♣ 6	8
9. S	♥ <u>10</u>	♣ 8	♣ 10	♠ 2
10. S	♥ <u>J</u>	♦ 8	♣ J	♠ 4
11. S	♠ 3	♦ 7	9	-

Made 4 — NS +630



**Board 839**  
 West Deals  
 N-S Vul

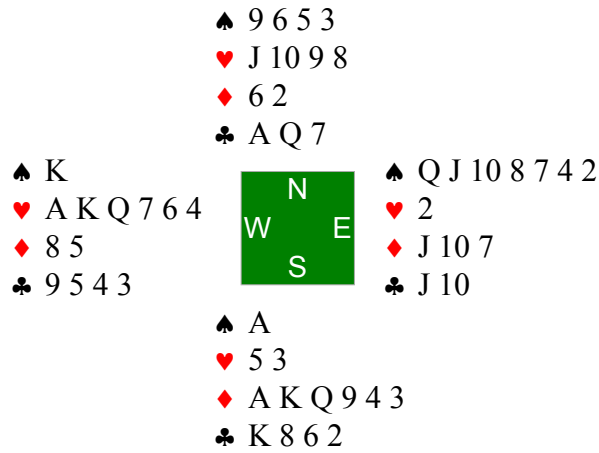

NS 4N; NS 5♦; NS 4♣; NS 2♥; EW 1♠; Par +630

West	North	East	South
<i>Alamiro</i>	<i>smispi</i>	<i>Harmon</i>	<i>jec</i>
1 ♥	Pass	1 ♠	Dbl
2 ♥	Pass	2 ♠	3 ♦
Pass	3 NT	Pass	Pass

Pass

3 NT by North

Trick	Lead	2nd	3rd	4th
1. E	♥ 2	3	Q	8
2. W	♥ K	9	♠ 4	5
3. W	♠ K	3	7	A
4. S	♦ A	5	2	7
5. S	♦ K	8	6	10
6. S	♦ Q	♥ 4	♠ 5	J
7. S	♦ 9	♥ 6	♠ 6	♣ 10
8. S	♦ 4	♥ 7	♥ 10	♠ 2
9. S	♦ 3	♣ 3	♠ 9	♠ 8
10. S	♣ 2	5	A	J
11. N	♣ Q	♠ 10	6	4

Made 5 — NS +660

**Board 840**  
 North Deals  
 None Vul

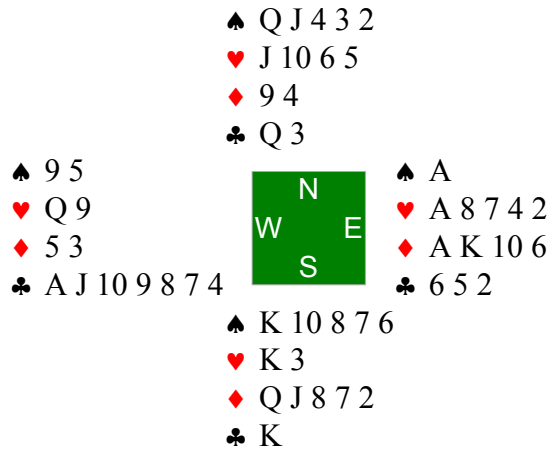

EW 5♣; EW 2N; NS 2♠; EW 2♥; E 1♦; Par -400

West	North	East	South
<i>edrijver</i>	<i>llorenzo</i>	<i>Harmon</i>	<i>jec</i>
	Pass	1 ♥	2 ♥ <sup>1</sup>
3 ♣	4 ♠	5 ♣	Pass
Pass	Pass		

1. s+d

5 ♣ by West

Trick	Lead	2nd	3rd	4th
1. N	♦ 9	<u>A</u>	7	3
2. E	<u>♠ A</u>	6	5	2
3. E	♣ 2	K	<u>A</u>	3
4. W	♠ 9	Q	<u>♣ 5</u>	7
5. E	♣ 6	♠ 8	4	<u>Q</u>
6. N	♥ 5	2	<u>K</u>	9
7. S	♦ Q	5	4	<u>K</u>

Made 5 — NS -400

**Board 848**  
 North Deals  
 E-W Vul

♠ 9 6 2	♠ Q 3	♠ A K J 10 8 7 4
♥ A 10 2	♥ Q 9 5 3	♥ J 7
♦ K 8 6 4 2	♦ A Q 5	♦ J 3
♣ 7 6	♣ J 9 4 3	♣ A 10

♠ 5
♥ K 8 6 4
♦ 10 9 7
♣ K Q 8 5 2

EW 3N; EW 3♠; NS 3♥; EW 2♦; NS 2♣; Par -100: NS 4♥×-1

West	North	East	South
<i>edrijver</i>	<i>llorenzo</i>	<i>Harmon</i>	<i>jec</i>
	Pass	1 ♠	Pass
2 ♠	Pass	Pass	Dbl
Pass	3 ♥	3 ♠	Pass
Pass	Pass		

3 ♠ by East

<i>Trick</i>	<i>Lead</i>	<i>2nd</i>	<i>3rd</i>	<i>4th</i>
1. S	♥ 6	2	<u>Q</u>	J
2. N	♣ 9	<u>A</u>	5	6
3. E	♠ A	5	2	3
4. E	♠ K	♣ 2	6	Q
5. E	♥ 7	4	<u>10</u>	5
6. W	♥ A	3	♣ 10	8
7. W	♣ 7	4	<u>♠ 8</u>	8
8. E	♦ 3	9	K	<u>A</u>
9. N	♦ Q	-	-	-

Made 4 — NS -170

**Board 852**  
 North Deals  
 Both Vul

♠ A Q 7 5 3 ♥ K 7 ♦ J 9 5 ♣ 10 9 6		♠ K 9 8 4 ♥ J 6 4 2 ♦ 7 4 3 ♣ 5 3	♠ J 6 2 ♥ A Q 10 5 3 ♦ 8 2 ♣ A J 4
♠ 10 ♥ 9 8 ♦ A K Q 10 6 ♣ K Q 8 7 2			

EW 3♠; EW 2♥; EW 1N; NS 2♦; Par -140

West	North	East	South
<i>edrijver</i>	<i>llorenzo</i>	<i>Harmon</i>	<i>jec</i>
	Pass	1♥	2NT
Dbl	3♦	Pass	Pass
Pass			

3♦ by North

<i>Trick</i>	<i>Lead</i>	<i>2nd</i>	<i>3rd</i>	<i>4th</i>
1. E	♦ 2	<u>A</u>	5	3
2. S	♣ K	6	3	<u>A</u>
3. E	♠ J	10	<u>A</u>	4
4. W	♥ K	2	3	8
5. W	♥ 7	J	<u>Q</u>	9
6. E	♦ 8	<u>K</u>	9	4
7. S	♣ Q	9	5	4
8. S	♣ 2	10	♦ 7	J
9. N	♠ 8	2	♦ 6	3
10. S	♦ Q	J	♥ 4	♠ 6

Made 3 — NS +110

**Board 855**  
 West Deals  
 E-W Vul

♠ Q 8 4 ♥ Q 2 ♦ A 7 4 2 ♣ 9 6 5 2	♠ 10 6 5 3 ♥ 8 7 5 ♦ J 10 6 5 ♣ J 10	<div style="text-align: center; border: 1px solid black; width: 40px; height: 40px; margin: 0 auto; background-color: #006400; color: white; display: flex; flex-direction: column; align-items: center; justify-content: center;"> <span>N</span> <span>W</span> <span>S</span> <span>E</span> </div>	♠ A 7 ♥ A 9 4 3 ♦ K 8 ♣ A 8 7 4 3
	♠ K J 9 2 ♥ K J 10 6 ♦ Q 9 3 ♣ K Q		

EW 3N; E 5♣; EW 3♥; W 4♣; EW 2♠; EW 2♦; Par -600

West	North	East	South
<i>edrijver</i>	<i>llorenzo</i>	<i>Harmon</i>	<i>jec</i>
Pass	Pass	1 NT	2 ♣ <sup>1</sup>
Pass	2 ♠	Pass	Pass
2 NT <sup>2</sup>	Pass	3 ♣	Pass
Pass	Pass		

1. MM

2. mm

3 ♣ by East

<i>Trick</i>	<i>Lead</i>	<i>2nd</i>	<i>3rd</i>	<i>4th</i>
1. S	♣ K	2	J	<u>A</u>
2. E	♣ 3	<u>Q</u>	5	10
3. S	♦ 3	2	10	<u>K</u>
4. E	♥ 3	<u>K</u>	2	5
5. S	♦ Q	<u>A</u>	5	8
6. W	♦ 4	6	<u>♣ 7</u>	9
7. E	♠ 7	<u>K</u>	4	3

Made 4 — NS -130

**Board 858**  
 South Deals  
 E-W Vul

♠ K Q J 8 7	♠ A 5 4 2	♠ —
♥ —	♥ K 9 3	♥ A Q J 8 5 2
♦ A 6 4	♦ K Q J 3	♦ 8 7 5 2
♣ A K 9 7 5	♣ J 10	♣ 8 4 3

♠ 10 9 6 3
♥ 10 7 6 4
♦ 10 9
♣ Q 6 2

EW 4♥; EW 5♣; EW 4♦; EW 2♠; EW 1N; Par -620

West	North	East	South
<i>edrijver</i>	<i>llorenzo</i>	<i>Harmon</i>	<i>jec</i>
			Pass
1 ♣	Dbl	1 ♥	Pass
2 ♠	Pass	3 ♣	Pass
3 ♦ <sup>1</sup>	Dbl	3 ♥	Pass
4 ♣	Pass	Pass	Pass

1. no agreements

4 ♣ by West

Trick	Lead	2nd	3rd	4th
1. N	♦ K	2	10	<u>A</u>
2. W	♠ 7	4	<u>♣ 3</u>	3
3. E	♥ A	7	♦ 4	3
4. E	♥ Q	4	♦ 6	<u>K</u>
5. N	♣ J	4	2	<u>K</u>
6. W	♠ K	2	♦ 5	6
7. W	♠ Q	5	♦ 7	10
8. W	♠ 8	A	<u>♣ 8</u>	9
9. E	♥ J	6	♠ J	9
10. E	♦ 8	9	<u>♣ 5</u>	J
11. W	♣ A	10	♥ 2	6
12. W	♣ 7	♦ 3	♥ 5	<u>Q</u>
13. S	♥ 10	<u>♣ 9</u>	♦ Q	8

Made 5 — NS -150

**Board 861**  
 East Deals  
 E-W Vul

♠ A K 10 9 7 6 3	♠ J 2	♠ Q 8 5 4
♥ 7 5	♥ A J 9 6 4	♥ 2
♦ Q 4	♦ K 8 6 2	♦ 7 5 3
♣ 5 2	♣ A 10	♣ K Q 9 6 4
	♠ —	
	♥ K Q 10 8 3	
	♦ A J 10 9	
	♣ J 8 7 3	

NS 6♥; NS 6♦; EW 3♠; NS 1♣; Par +800: EW 6♠×-3

West	North	East	South
<i>edrijver</i>	<i>llorenzo</i>	<i>Harmon</i>	<i>jec</i>
		Pass	Pass
3 ♠	Pass	Pass	Dbl
Pass	4 ♥	4 ♠	5 ♥
Pass	6 ♥	Pass	Pass
Pass			

6 ♥ by North

Trick	Lead	2nd	3rd	4th
1. E	♠ Q	♥ 3	7	2
2. S	♥ K	5	4	2
3. S	♥ 8	7	♠ J	♠ 4
4. N	♠ J	5	♥ 10	6
5. S	♣ 3	2	♠ A	4
6. N	♣ 10	♠ K	7	5
7. E	♠ 8	♥ Q	3	♦ 2
8. S	♣ 8	♠ 9	♥ 6	9
9. N	♥ A	♣ 6	♦ 9	♠ 10
10. N	♥ 9	♦ 3	♣ J	♠ K
11. N	♦ K	5	10	4
12. N	♦ 6	7	♠ A	Q
13. S	♦ J	♠ A	8	♣ Q

Made 6 — NS +980

**Board 862**  
 South Deals  
 Both Vul

♠ Q J 10 5 ♥ K 6 ♦ 7 ♣ A K 9 6 5 2		♠ 7 ♥ A 9 7 4 2 ♦ K 10 6 4 3 ♣ Q 8	♠ A 9 8 2 ♥ Q ♦ A Q J 5 2 ♣ 10 4 3
♠ K 6 4 3 ♥ J 10 8 5 3 ♦ 9 8 ♣ J 7			

EW 5♠; EW 4N; EW 5♣; EW 2♦; NS 1♥; Par -650

West	North	East	South
<i>edrijver</i>	<i>llorenzo</i>	<i>Harmon</i>	<i>jec</i>
			Pass
1 ♣	1 ♥	2 ♦	4 ♥
Pass	Pass	4 ♠	Pass
Pass	Pass		

4 ♠ by East

Trick	Lead	2nd	3rd	4th
1. S	♥ J	6	<u>A</u>	Q
2. N	♠ 7	2	6	<u>Q</u>
3. W	♠ J	♥ 2	8	<u>K</u>
4. S	♠ 3	5	♥ 4	<u>9</u>
5. E	<u>♠ A</u>	4	10	♥ 7
6. E	♣ 3	7	<u>A</u>	8
7. W	♣ 2	<u>Q</u>	4	J

Made 4 — NS -620



**Board 866**  
 South Deals  
 None Vul

♠ A 7 5		♠ Q J 9 6 4
♥ K 9 8 7 4		♥ 10 5 3
♦ A K J 6		♦ Q 7 4 3
♣ 3		♣ 5
♠ K 10 8 3 2	<div style="display: inline-block; background-color: green; color: white; padding: 5px; border: 1px solid black;">           N            W     E            S         </div>	♠ —
♥ 6		♥ A Q J 2
♦ 9 2		♦ 10 8 5
♣ A K 9 8 7		♣ Q J 10 6 4 2

NS 5♥; EW 3♠; NS 4♦; NS 2N; NS 2♣; Par +300; EW 5♠×-2

West <i>edrijver</i>	North <i>llorenzo</i>	East <i>Harmon</i>	South <i>jec</i>
			Pass
1 ♠	Pass	4 ♠	5 ♣
Pass	Pass	Pass	

5 ♣ by South

Trick	Lead	2nd	3rd	4th
1. W	♠ 2	<u>A</u>	4	♦ 5
2. N	♣ 3	5	10	<u>K</u>
3. W	♠ 3	5	9	<u>♣ 2</u>
4. S	♣ J	<u>A</u>	♥ 4	♠ 6
5. W	♠ 8	7	J	<u>♣ 4</u>
6. S	♥ <u>A</u>	6	7	3
7. S	♥ J	<u>♣ 7</u>	8	5
8. W	♠ K	♦ 6	Q	<u>♣ 6</u>
9. S	<u>♣ Q</u>	8	♦ J	♦ 3
10. S	♥ 2	<u>♣ 9</u>	K	10
11. W	<u>♠ 10</u>	♥ 9	♦ 4	♦ 8
12. W	♦ 2	-	-	-

Down 3 — NS -150

**Board 873**  
 East Deals  
 E-W Vul

♠ 8 6 2 ♥ J 9 6 2 ♦ A K 8 ♣ Q 10 9		♠ A K 5 ♥ A K 8 7 ♦ Q J 6 4 2 ♣ 8  ♠ Q 9 7 4 3 ♥ Q 10 4 ♦ 5 ♣ A K 4 2  ♠ J 10 ♥ 5 3 ♦ 10 9 7 3 ♣ J 7 6 5 3
---	---	---

EW 2♠; NS 2♦; EW 1♥; EW 1♣; Par -100; NS 3♦×-1

West	North	East	South
<i>Rodal F</i>	<i>BridgeGoth</i>	<i>leroumain</i>	<i>jec</i>
		1 ♠	Pass
2 ♠	3 ♦	Pass	Pass
3 ♠	Pass	Pass	Pass

3 ♠ by East

<i>Trick</i>	<i>Lead</i>	<i>2nd</i>	<i>3rd</i>	<i>4th</i>
1. S	♦ 7	<u>A</u>	2	5
2. W	♠ 2	<u>A</u>	4	10
3. N	<u>♥ A</u>	Q	5	2
4. N	<u>♥ K</u>	10	3	6
5. N	♥ 7	4	<u>♠ J</u>	9
6. S	♦ 3	<u>K</u>	4	♣ 2
7. W	♠ 6	<u>K</u>	3	♣ 3
8. N	♣ 8	-	-	-

Down 1 — NS +100

**Board 880**  
 North Deals  
 Both Vul

♠ A 6 4 3		♠ K 10 8 5 2
♥ 9 6 5		♥ K J 10 2
♦ Q 7 6 2		♦ 9 8
♣ 6 3		♣ A Q
♠ Q J 9 7	<div style="display: inline-block; background-color: green; color: white; padding: 5px; border: 1px solid black;">           N            W     E            S         </div>	
♥ 8		
♦ A K 3		
♣ 9 7 5 4 2		
♠ —		
♥ A Q 7 4 3		
♦ J 10 5 4		
♣ K J 10 8		

EW 4♠; NS 3♦; EW 1N; EW 2♣; NS 1♥; Par -500: NS 5♦ ×-2

West	North	East	South
<i>Rodal F</i>	<i>BridgeGoth</i>	<i>leroumain</i>	<i>jec</i>
	Pass	1 ♠	Dbl
3 ♥ <sup>1</sup>	Pass	3 ♠	Pass
Pass	Pass		

1. minisplinter

3 ♠ by East

<i>Trick</i>	<i>Lead</i>	<i>2nd</i>	<i>3rd</i>	<i>4th</i>
1. S	♦ J	<u>K</u>	7	8
2. W	♦ <u>A</u>	2	9	4
3. W	♦ 3	Q	<u>♠ 8</u>	5
4. E	♠ 2	♥ 3	<u>7</u>	3
5. W	♥ 8	5	10	<u>Q</u>
6. S	♥ 4	♣ 2	9	<u>J</u>
7. E	♥ 2	7	<u>♠ 9</u>	6
8. W	♣ 4	6	<u>A</u>	10
9. E	♥ K	A	♠ J	<u>♠ A</u>
10. N	♠ 4	5	♣ 8	<u>Q</u>

Made 4 — NS -170

**Board 881**  
 East Deals  
 None Vul

♠ 9	♠ A J 4 3	♠ K 7 5
♥ K 9 5 4	♥ A Q 10 3	♥ J 2
♦ A 6 3	♦ 9 7	♦ K 8 5 4 2
♣ K Q 8 5 4	♣ J 7 3	♣ 9 6 2
	<div style="display: inline-block; background-color: green; color: white; padding: 5px; border: 1px solid black;">           N            W     E            S         </div>	
	♠ Q 10 8 6 2	
	♥ 8 7 6	
	♦ Q J 10	
	♣ A 10	

NS 2♠; EW 2♦; EW 2♣; NS 1♥; Par +100: EW 3♣×-1; EW 3♦×-1

West	North	East	South
<i>Rodal F</i>	<i>BridgeGoth</i>	<i>leroumain</i>	<i>jec</i>
		Pass	Pass
1 ♣	Dbl	1 ♦	2 ♠
Pass	Pass	Pass	

2 ♠ by South

Trick	Lead	2nd	3rd	4th
1. W	♣ K	3	2	<u>A</u>
2. S	♠ 10	9	3	<u>K</u>
3. E	♦ 2	J	<u>A</u>	7
4. W	♦ 6	9	<u>K</u>	Q
5. E	♣ 9	10	<u>Q</u>	7
6. W	♣ 5	<u>J</u>	6	♥ 6
7. N	♠ J	5	2	♦ 3
8. N	♠ 4	7	<u>8</u>	♣ 4
9. S	♥ 7	4	Q	2

Made 3 — NS +140

**Board 885**  
 East Deals  
 N-S Vul

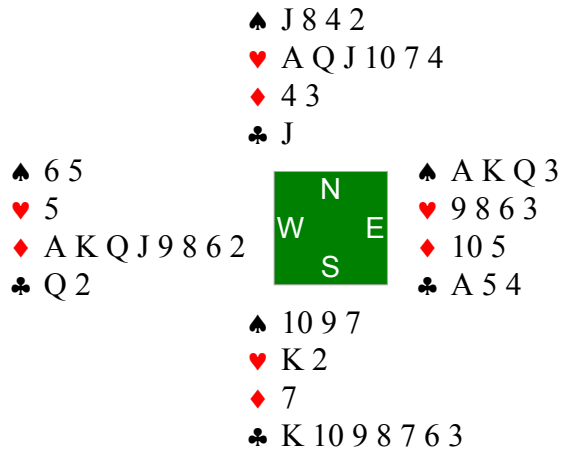

EW 6♦; EW 2♠; EW 1N; NS 1♥; Par -920

West	North	East	South
<i>Rodal F</i>	<i>BridgeGoth</i>	<i>leroumain</i>	<i>jec</i>
		1 ♣	Pass
1 ♦	1 ♥	Pass	Pass
2 ♥	Pass	2 ♠	Pass
5 ♦	Pass	Pass	Pass
5 ♦ by West			
Lead: ♣ J			
Made 6 — NS -420			

**Board 886**  
 South Deals  
 E-W Vul

♠ K 5 3 2 ♥ K Q 5 ♦ 8 5 4 ♣ K 4 2	♠ Q J 10 6 4 ♥ 9 7 3 2 ♦ Q ♣ 10 7 6	<div style="text-align: center; border: 1px solid black; width: 40px; height: 40px; margin: 0 auto; background-color: #006400; color: white; display: flex; flex-direction: column; align-items: center; justify-content: center;"> <span>N</span> <span>W</span> <span>E</span> <span>S</span> </div>	♠ 8 7 ♥ A J 10 4 ♦ A K J 10 6 3 ♣ 3
♠ A 9 ♥ 8 6 ♦ 9 7 2 ♣ A Q J 9 8 5			

EW 5N; EW 5♥; EW 5♦; EW 2♠; NS 2♣; Par -660

West	North	East	South
<i>Rodal F</i>	<i>BridgeGoth</i>	<i>leroumain</i>	<i>jec</i>
Pass	Pass	1 ♦	2 ♣
Dbl	Pass	2 ♥	Pass
Pass	Pass		

2 ♥ by East

<i>Trick</i>	<i>Lead</i>	<i>2nd</i>	<i>3rd</i>	<i>4th</i>
1. S	♥ 6	5	2	<u>10</u>
2. E	♣ 3	<u>A</u>	2	6
3. S	♣ Q	<u>K</u>	7	♠ 7
4. W	♦ 4	Q	<u>A</u>	2
5. E	♥ 4	8	<u>Q</u>	3

Made 5 — NS -200

**Board 891**  
 West Deals  
 None Vul

♠ K 8 4 3 2 ♥ — ♦ J 8 4 ♣ A K Q J 4	♠ A Q 6 5 ♥ K Q 10 5 ♦ A 9 6 ♣ 10 3		♠ J 10 9 ♥ J 8 7 6 ♦ K 10 3 ♣ 8 7 6
	♠ 7 ♥ A 9 4 3 2 ♦ Q 7 5 2 ♣ 9 5 2		

NS 4♥; NS 2N; EW 2♠; NS 3♦; EW 1♣; Par +300; EW 4♠×-2

West	North	East	South
<i>Rodal F</i>	<i>BridgeGoth</i>	<i>leroumain</i>	<i>jec</i>
1 ♣	Dbl	Pass	1 ♥
1 ♠	2 ♥	Pass	3 ♦
Pass	4 ♥	Pass	Pass

Pass

4 ♥ by South

<i>Trick</i>	<i>Lead</i>	<i>2nd</i>	<i>3rd</i>	<i>4th</i>
1. W	<u>♣ A</u>	3	6	2
2. W	<u>♣ K</u>	10	7	9
3. W	<u>♣ Q</u>	<u>♥ 10</u>	8	5
4. N	<u>♥ Q</u>	6	2	♠ 2
5. N	<u>♥ K</u>	7	3	♣ 4
6. N	♥ 5	8	<u>9</u>	♣ J
7. S	<u>♥ A</u>	♠ 3	♦ 6	J
8. S	♠ 7	4	<u>Q</u>	J
9. N	<u>♠ A</u>	9	♦ 2	8
10. N	♠ 5	10	♦ 5	<u>K</u>
11. W	♦ 4	9	<u>K</u>	7
12. E	♦ 3	Q	8	<u>A</u>
13. N	♠ 6	♦ 10	<u>♥ 4</u>	♦ J

Down 1 — NS -50

**Board 899**  
West Deals  
Both Vul

♠ A Q 9 5 3 2	♠ J	♠ 10 7 4
♥ 8 6 4	♥ K Q 3	♥ 5
♦ J 10 7	♦ K 8 6 5 4 2	♦ 9 3
♣ 4	♣ A Q 9	♣ K 10 8 7 5 3 2

♠ K 8 6
♥ A J 10 9 7 2
♦ A Q
♣ J 6

S 6N; NS 6♥; NS 6♦; N 5N; EW 1♠; NS 1♣; Par +1440

West	North	East	South
<i>pdc</i>	<i>ollina</i>	<i>smispi</i>	<i>jec</i>
2 ♠	Dbl	Pass	4 ♥
Pass	Pass	Pass	

4 ♥ by South

Trick	Lead	2nd	3rd	4th
1. W	♣ 4	9	<u>K</u>	6
2. E	♣ 5	J	<u>♥ 4</u>	Q
3. W	♦ J	2	3	<u>A</u>
4. S	<u>♥ A</u>	6	3	5
5. S	♥ 2	8	<u>Q</u>	♣ 2
6. N	<u>♣ A</u>	3	♠ 6	♠ 3
7. N	♦ 4	9	<u>Q</u>	7
8. S	♥ 7	♠ 2	<u>K</u>	♣ 7

Made 5 — NS +650



**Board 901**  
 East Deals  
 E-W Vul

♠ J 10 5 4 ♥ 5 4 ♦ K 9 3 ♣ 6 4 3 2	<div style="background-color: green; color: white; padding: 5px; display: inline-block;">           N            W     E            S         </div>	♠ K 8 3 ♥ K Q 10 3 ♦ 10 7 6 4 ♣ 9 5	♠ 2 ♥ J 8 7 6 2 ♦ A J ♣ A Q J 10 8
♠ A Q 9 7 6 ♥ A 9 ♦ Q 8 5 2 ♣ K 7			

NS 2♠; NS 3♦; NS 1N; EW 2♣; NS 1♥; Par +110

West	North	East	South
<i>pdc</i>	<i>ollina</i>	<i>smispi</i>	<i>jec</i>
		1 ♥	1 ♠
Pass	2 ♠	Pass	Pass
Pass			

2 ♠ by South

<i>Trick</i>	<i>Lead</i>	<i>2nd</i>	<i>3rd</i>	<i>4th</i>
1. W	♥ 5	3	2	<u>9</u>
2. S	♥ <u>A</u>	4	10	6
3. S	♠ <u>A</u>	4	3	2
4. S	♠ <u>Q</u>	5	8	♥ 7
5. S	♠ 6	10	<u>K</u>	♥ 8
6. N	♣ 5	<u>A</u>	7	2
7. E	♣ <u>Q</u>	<u>K</u>	3	9
8. S	♦ 2	3	10	<u>J</u>
9. E	♣ <u>J</u>	♠ <u>7</u>	4	♦ 4
10. S	♦ 5	9	6	<u>A</u>
11. E	♣ 8	♠ <u>9</u>	6	♦ 7
12. S	♦ 8	-	-	-

Made 2 — NS +110

**Board 902**  
 South Deals  
 Both Vul

♠ Q		♠ A 10 5
♥ J 9 4 3		♥ A
♦ J 9 8 7		♦ A Q 10 3 2
♣ J 8 4 3		♣ A Q 9 5
	♠ J 9 8 6 2	
	♥ K 10 8 5 2	
	♦ K	
	♣ K 10	

EW 6♦; EW 6♣; EW 4N; NS 2♠; NS 1♥; Par -1100: NS 6♠×-4

West	North	East	South
<i>pdc</i>	<i>ollina</i>	<i>smispi</i>	<i>jec</i>
			Pass
Pass	Pass	1♦	2♦
3♦	3♠	6♦	Pass
Pass	Pass		

6♦ by East

<i>Trick</i>	<i>Lead</i>	<i>2nd</i>	<i>3rd</i>	<i>4th</i>
1. S	♠ 2	Q	K	<u>A</u>
2. E	♠ 5	8	<u>♦ 7</u>	4
3. W	♦ 8	4	2	<u>K</u>
4. S	♠ J	<u>♦ 9</u>	7	10
5. W	♣ J	2	5	<u>K</u>
6. S	♣ 10	3	6	<u>A</u>

Down 1 — NS +100

**Board 903**  
 West Deals  
 None Vul

♠ Q 7 4 ♥ K 7 4 ♦ 9 8 5 4 2 ♣ 8 2		♠ 9 8 2 ♥ Q 10 9 ♦ K 10 ♣ J 9 7 4 3	♠ A K J 6 5 ♥ 8 6 5 2 ♦ A J ♣ 10 6
♠ 10 3 ♥ A J 3 ♦ Q 7 6 3 ♣ A K Q 5			

EW 2♠; NS 3♣; EW 1♥; EW 1♦; Par +100; EW 3♠×-1

West	North	East	South
<i>pdc</i>	<i>ollina</i>	<i>smispi</i>	<i>jec</i>
Pass	Pass	1 ♠	Dbl
2 ♠	Pass	Pass	Dbl
Pass	3 ♣	3 ♠	Pass
Pass	4 ♣	Pass	Pass
Pass			

4 ♣ by North

<i>Trick</i>	<i>Lead</i>	<i>2nd</i>	<i>3rd</i>	<i>4th</i>
1. E	<u>♠ A</u>	3	4	8
2. E	<u>♠ K</u>	10	7	9
3. E	♠ 5	<u>♣ Q</u>	Q	2
4. S	<u>♣ A</u>	2	3	6
5. S	<u>♣ K</u>	8	4	10
6. S	♦ 3	2	K	<u>A</u>
7. E	♦ J	<u>Q</u>	4	10
8. S	♦ 6	8	<u>♣ 7</u>	♠ 6
9. N	♥ Q	5	3	<u>K</u>

Down 1 — NS -50

**Board 908**  
 North Deals  
 Both Vul

♠ Q 7 5 ♥ K 8 7 3 ♦ A K 6 ♣ J 7 5		♠ — ♥ Q 4 2 ♦ J 4 3 2 ♣ A Q 6 4 3 2	♠ A K 9 8 3 ♥ A 10 9 6 ♦ 10 9 ♣ 10 9
♠ J 10 6 4 2 ♥ J 5 ♦ Q 8 7 5 ♣ K 8			

EW 3♠; W 3♥; E 2♥; EW 1N; NS 1♦; NS 1♣; Par -140

West	North	East	South
<i>pdc</i>	<i>ollina</i>	<i>smispi</i>	<i>jec</i>
	Pass	1 ♠	Pass
2 ♣	Dbl	2 ♥	3 ♦
4 ♥	Pass	Pass	Pass

4 ♥ by East

<i>Trick</i>	<i>Lead</i>	<i>2nd</i>	<i>3rd</i>	<i>4th</i>
1. S	♦ 7	<u>A</u>	4	9
2. W	♥ 3	2	<u>A</u>	5
3. E	♥ 6	J	<u>K</u>	4
4. W	♠ 5	♦ 2	<u>A</u>	2
5. E	♠ 3	10	Q	<u>♥ Q</u>
6. N	<u>♣ A</u>	9	8	5
7. N	♣ 2	10	<u>K</u>	7

Made 4 — NS -620

**Board 911**  
 West Deals  
 E-W Vul

♠ 8	♠ A K J 3	♠ 10 6 5 2
♥ 10 2	♥ K Q J 6 4	♥ A 7 3
♦ A Q 7 4 3	♦ 5 2	♦ J 9 6
♣ A Q 6 4 3	♣ K 9	♣ J 10 7
	<div style="display: inline-block; background-color: green; color: white; padding: 5px; border: 1px solid black;">           N            W     E            S         </div>	
	♠ Q 9 7 4	
	♥ 9 8 5	
	♦ K 10 8	
	♣ 8 5 2	

NS 3♠; NS 2♥; EW 3♦; EW 3♣; Par +140

West	North	East	South
<i>pdc</i>	<i>ollina</i>	<i>smispi</i>	<i>jec</i>
1 ♦	1 ♥	Pass	2 ♥
Pass	4 ♥	Pass	Pass
Pass			

4 ♥ by North

<i>Trick</i>	<i>Lead</i>	<i>2nd</i>	<i>3rd</i>	<i>4th</i>
1. E	♦ 6	8	<u>Q</u>	5
2. W	♠ 8	<u>A</u>	5	4
3. N	♥ K	<u>A</u>	5	2
4. E	♠ 2	7	<u>♥ 10</u>	J
5. W	<u>♣ A</u>	9	7	2
6. W	♣ 4	<u>K</u>	10	5
7. N	♥ 4	3	<u>8</u>	♦ 4
8. S	♥ 9	♣ 3	<u>Q</u>	7
9. N	<u>♥ J</u>	♠ 6	♣ 8	♦ 3
10. N	<u>♥ 6</u>	♣ J	♦ 10	♦ 7

Down 2 — NS -100

**Board 921**  
 West Deals  
 Both Vul

♠ K 8 6 5	♠ Q 10 9 7 3	♠ —
♥ 10 6 4	♥ A J 7 3	♥ Q 9 5
♦ J 8 7 6	♦ 5 3	♦ K Q 10 9 2
♣ K 4	♣ 10 6	♣ A 9 5 3 2

♠ A J 4 2
♥ K 8 2
♦ A 4
♣ Q J 8 7

EW 4♦; NS 2♠; NS 2♥; EW 1♣; Par -130

West	North	East	South
<i>gebeceli</i>	<i>ronpa</i>	<i>orhan_aga</i>	<i>jec</i>
Pass	Pass	1♦	Dbl
1♠	Dbl	2♣	Dbl
2♦	2♥	Pass	2♠
Pass	3♠	Pass	4♠
Pass	Pass	Pass	

4♠ by South

Trick	Lead	2nd	3rd	4th
1. W	♦ 7	3	Q	<u>A</u>
2. S	♣ 7	<u>K</u>	6	5
3. W	♦ 6	5	<u>K</u>	4
4. E	<u>♣ A</u>	8	4	10
5. E	♣ 2	Q	♥ 4	♥ 3
6. S	♥ 2	10	<u>A</u>	5
7. N	<u>♠ 10</u>	♦ 10	2	5
8. N	♠ 3	♦ 2	J	<u>K</u>
9. W	♠ 6	7	♦ 9	<u>A</u>
10. S	♠ 4	8	<u>9</u>	♣ 3
11. N	<u>♠ Q</u>	♣ 9	♥ 8	♦ J
12. N	♥ 7	9	<u>K</u>	6
13. S	♣ J	♦ 8	♥ J	♥ Q

Down 1 — NS -100

**Board 929**  
 West Deals  
 N-S Vul

♠ 9 7 5 3 2	♠ K 6 4	♠ A Q 10 8
♥ 10 5 2	♥ A Q 8 4	♥ K 3
♦ 10 3	♦ 8 4 2	♦ 9 7 6 5
♣ A K 4	♣ 10 8 7	♣ J 5 2

♠ J
♥ J 9 7 6
♦ A K Q J
♣ Q 9 6 3

EW 3♠; N 3♥; EW 2N; S 2♥; NS 1♦; NS 1♣; Par -140

West	North	East	South
<i>gebeceli</i>	<i>ronpa</i>	<i>orhan_aga</i>	<i>jec</i>
Pass	Pass	1 ♠	Dbl
2 ♥ <sup>1</sup>	3 ♥	Pass	Pass
3 ♠	Pass	Pass	Pass

1. ♠

3 ♠ by East

<i>Trick</i>	<i>Lead</i>	<i>2nd</i>	<i>3rd</i>	<i>4th</i>
1. S	♦ <u>A</u>	3	2	5
2. S	♦ <u>J</u>	10	8	6
3. S	♥ 6	2	<u>A</u>	3
4. N	♥ 4	<u>K</u>	7	5
5. E	♠ <u>A</u>	J	2	4
6. E	♦ 7	Q	♠ <u>3</u>	4
7. W	♥ 10	Q	♠ <u>10</u>	9
8. E	♦ 9	K	♠ <u>7</u>	♣ 7
9. W	♠ 5	<u>K</u>	8	♥ J
10. N	♠ 6	<u>Q</u>	♣ 3	9
11. E	♣ 2	6	<u>A</u>	10
12. W	♣ <u>K</u>	8	5	9
13. W	♣ 4	♥ 8	J	<u>Q</u>

Down 1 — NS +50

**Board 931**  
 East Deals  
 None Vul

♠ K 4		♠ J 9 6	
♥ 10 5 4		♥ A	
♦ J 5		♦ A 10 6 4	
♣ K J 9 7 3 2		♣ A 10 8 6 5	
	<div style="display: inline-block; background-color: green; color: white; padding: 5px; border: 1px solid black;">           N            W     E            S         </div>		
		♠ 3 2	
		♥ K Q 8 7 6 3 2	
		♦ K Q 7	
		♣ Q	
		♠ A Q 10 8 7 5	
		♥ J 9	
		♦ 9 8 3 2	
		♣ 4	

NS 4♠; NS 4♦; EW 2♥; EW 1♣; Par +420

West	North	East	South
<i>gebeceli</i>	<i>ronpa</i>	<i>orhan_aga</i>	<i>jec</i>
		1 ♥	2 ♠
3 ♥	4 ♠	Pass	Pass

Pass

4 ♠ by South

<i>Trick</i>	<i>Lead</i>	<i>2nd</i>	<i>3rd</i>	<i>4th</i>
1. W	♥ 4	<u>A</u>	2	9
2. N	♠ J	3	5	<u>K</u>
3. W	♠ 4	6	2	<u>10</u>
4. S	♥ J	5	<u>♠ 9</u>	7
5. N	♦ 4	<u>Q</u>	2	5
6. E	♣ Q	4	7	<u>A</u>
7. N	♣ 5	♥ 3	<u>♠ 7</u>	3
8. S	♦ 3	J	<u>A</u>	7
9. N	♦ 6	<u>K</u>	8	♣ 2
10. E	♥ K	-	-	-

Made 4 — NS +420



**Board 945**  
 West Deals  
 N-S Vul

♠ K Q J 5 3	♠ A 6 4	♠ 10 9 8 7 2
♥ A Q 10 9	♥ K 8	♥ J 7 6 3
♦ 10 5	♦ A Q 8 7 6 4	♦ —
♣ 9 2	♣ Q 5	♣ A 10 7 3

♠ —
♥ 5 4 2
♦ K J 9 3 2
♣ K J 8 6 4

EW 4♠; NS 5♦; EW 3♥; NS 3♣; NS 1N; Par +100: EW 5♠×-1

West	North	East	South
<i>gebeceli</i>	<i>ronpa</i>	<i>orhan_aga</i>	<i>jec</i>
1 ♠	2 ♦	4 ♠	5 ♦
5 ♠	Dbl	Pass	Pass

Pass

5 ♠× by West

<i>Trick</i>	<i>Lead</i>	<i>2nd</i>	<i>3rd</i>	<i>4th</i>
1. N	♦ A	♠ 2	2	5
2. E	♠ 10	♦ 3	3	4
3. E	♠ 7	♣ 8	K	<u>A</u>
4. N	♣ Q	<u>A</u>	4	2
5. E	♠ 8	♥ 2	5	6
6. E	♥ 6	4	10	<u>K</u>
7. N	♣ 5	-	-	-

Down 1 — NS +100

**Board 948**  
 South Deals  
 E-W Vul

♠ 9 7 4 3	<div style="display: inline-block; background-color: green; color: white; padding: 10px; border: 1px solid black;">           N W     E S         </div>	♠ A K 8 6 2
♥ 10 3		♥ J 9 5
♦ K Q J 8 6		♦ A 7
♣ 9 5		♣ K 6 3

♠ Q  
 ♥ Q 8 6  
 ♦ 9 3  
 ♣ A Q J 10 8 4 2

NS 3♥; EW 2♠; NS 3♣; EW 1♦; Par +140

West	North	East	South
<i>Harmon</i>	<i>miamiwiz</i>	<i>sympaaa</i>	<i>jec</i>
Pass	Pass	1 NT	Pass
Pass	Pass	Pass	3♣

3♣ by South

<i>Trick</i>	<i>Lead</i>	<i>2nd</i>	<i>3rd</i>	<i>4th</i>
1. W	<u>♦ K</u>	2	7	3
2. W	♦ 6	4	<u>A</u>	9
3. E	<u>♠ K</u>	Q	3	5
4. E	♣ 3	<u>Q</u>	5	7
5. S	<u>♣ A</u>	9	♥ 2	6
6. S	♣ J	♦ 8	♦ 5	<u>K</u>

Made 3 — NS +110

**Board 949**  
West Deals  
Both Vul

<p>♠ K J 4 ♥ K 9 4 ♦ Q 6 5 3 ♣ Q 8 3</p>		<p>♠ 7 5 3 ♥ Q 10 7 6 5 ♦ 9 8 ♣ K 7 2</p>	<p>♠ 6 ♥ A J 8 3 ♦ A K 7 4 2 ♣ A 10 9</p>
<p>♠ A Q 10 9 8 2 ♥ 2 ♦ J 10 ♣ J 6 5 4</p>			

EW 5N; EW 4♥; EW 5♦; EW 2♠; EW 3♣; Par -660

West	North	East	South
<i>Harmon</i>	<i>miamiwiz</i>	<i>sympaaa</i>	<i>jec</i>
Pass	Pass	1 ♦	2 ♠
2 NT	Pass	3 NT	Pass
Pass	Pass		

3 NT by West

<i>Trick</i>	<i>Lead</i>	<i>2nd</i>	<i>3rd</i>	<i>4th</i>
1. N	♠ 3	6	8	<u>J</u>
2. W	♦ 3	8	<u>A</u>	J
3. E	♦ 2	10	<u>Q</u>	9
4. W	♦ 5	♠ 7	<u>K</u>	♠ 2
5. E	<u>♦ 7</u>	♠ 9	6	♥ 5
6. E	<u>♦ 4</u>	♠ 10	♣ 3	♣ 2
7. E	<u>♥ A</u>	2	9	6
8. E	♥ 3	♣ 4	<u>K</u>	7
9. W	♥ 4	<u>Q</u>	8	♣ 5
10. N	♥ 10	<u>J</u>	♠ Q	♠ 4
11. E	♣ 9	6	8	<u>K</u>
12. N	♠ 5	♣ 10	<u>A</u>	K
13. S	♣ J	Q	7	<u>A</u>

Made 4 — NS -630

**Board 952**  
 South Deals  
 Both Vul

♠ 10 9		♠ A K 7
♥ 7 6 2		♥ A J 8 5
♦ A 6		♦ 8 4 2
♣ K Q J 10 5 2		♣ 7 6 3
♠ Q 5 4 3 2	<div style="display: inline-block; background-color: green; color: white; padding: 5px; border: 1px solid black;">           N            W      E            S         </div>	♠ J 8 6
♥ K 10 3		♥ Q 9 4
♦ K J 3		♦ Q 10 9 7 5
♣ A 4		♣ 9 8

EW 5♠; EW 5♥; EW 4N; EW 2♦; EW 1♣; Par -650

West	North	East	South
<i>Harmon</i>	<i>miamiwiz</i>	<i>sympaaa</i>	<i>jec</i>
			Pass
1 ♠	2 ♣	3 ♣	Pass
3 ♠	Pass	Pass	Pass

3 ♠ by West

<i>Trick</i>	<i>Lead</i>	<i>2nd</i>	<i>3rd</i>	<i>4th</i>
1. N	<u>♣ K</u>	3	9	4
2. N	♣ 10	6	8	<u>A</u>
3. W	♠ 3	9	<u>A</u>	6
4. E	♠ 7	8	<u>Q</u>	10
5. W	♠ 2	♣ 5	<u>K</u>	J
6. E	♥ 5	4	<u>10</u>	2
7. W	<u>♥ K</u>	6	8	9
8. W	♥ 3	7	<u>A</u>	Q
9. E	<u>♥ J</u>	♦ 7	♦ 3	♣ 2
10. E	♦ 2	9	J	<u>A</u>
11. N	♣ Q	-	-	-

Made 5 — NS -200

**Board 953**  
 West Deals  
 None Vul

♠ A J 9	♠ K 5 3 2	♠ 4
♥ J 2	♥ Q 9 3	♥ A 10 6 5 4
♦ K 4 3 2	♦ Q 6	♦ J 10 9 7
♣ 10 7 5 3	♣ K 8 4 2	♣ Q J 9

♠ Q 10 8 7 6
♥ K 8 7
♦ A 8 5
♣ A 6

NS 3♠; NS 1N; EW 2♦; NS 1♥; NS 1♣; Par +140

West	North	East	South
<i>Harmon</i>	<i>miamiwiz</i>	<i>sympaaa</i>	<i>jec</i>
Pass	Pass	1♥	1♠
1NT	2♠	Pass	Pass
Pass			

2♠ by South

<i>Trick</i>	<i>Lead</i>	<i>2nd</i>	<i>3rd</i>	<i>4th</i>
1. W	♥ J	Q	4	7
2. N	♠ 2	4	Q	<u>A</u>
3. W	♥ 2	3	<u>A</u>	8
4. E	♥ 5	K	<u>♠ 9</u>	9
5. W	♠ J	<u>K</u>	♥ 6	6
6. N	♦ Q	7	5	<u>K</u>
7. W	♦ 2	-	-	-

Made 3 — NS +140

**Board 957**  
 West Deals  
 N-S Vul

♠ A 5 ♥ Q 8 6 2 ♦ J 8 4 3 ♣ Q 10 7		♠ K 8 6 4 3 ♥ J 10 7 5 ♦ K 6 5 ♣ 5	♠ Q J ♥ 4 ♦ A 10 9 7 ♣ K J 9 8 4 3
♠ 10 9 7 2 ♥ A K 9 3 ♦ Q 2 ♣ A 6 2			

S 4♠; N 3♠; NS 3♥; EW 3♣; EW 1♦; Par +300; EW 5♣×-2

West	North	East	South
<i>Harmon</i>	<i>miamiwiz</i>	<i>sympaaa</i>	<i>jec</i>
Pass	Pass	3 ♣	Dbl
Pass	4 ♣	Pass	4 ♥
Pass	Pass	Pass	

4 ♥ by South

<i>Trick</i>	<i>Lead</i>	<i>2nd</i>	<i>3rd</i>	<i>4th</i>
1. W	♣ 7	5	J	<u>A</u>
2. S	♣ 2	10	<u>♥ 5</u>	3
3. N	♥ 7	4	<u>A</u>	2
4. S	♣ 6	Q	<u>♥ 10</u>	4
5. N	<u>♥ J</u>	♣ 8	3	6
6. N	♦ K	<u>A</u>	2	3
7. E	♣ K	<u>♥ 9</u>	♠ 5	♠ 3
8. S	<u>♥ K</u>	8	♦ 5	♣ 9
9. S	♠ 7	<u>A</u>	4	J
10. W	♦ 4	6	9	<u>Q</u>
11. S	♠ 10	<u>♥ Q</u>	6	Q
12. W	♦ 8	♠ 8	7	♠ 2
13. W	♦ J	♠ K	10	♠ 9

Down 2 — NS -200

**Board 966**  
 North Deals  
 N-S Vul

♠ J 8 3 ♥ Q 8 5 3 ♦ 6 3 2 ♣ J 8 6		♠ Q 9 5 2 ♥ A 4 2 ♦ K 7 ♣ Q 10 5 4	♠ A K 6 ♥ K 7 ♦ A 9 8 4 ♣ A 9 7 2
♠ 10 7 4 ♥ J 10 9 6 ♦ Q J 10 5 ♣ K 3			

NS 1N; NS 1♠; NS 1♥; NS 1♦; E 1♣; Par +90

West	North	East	South
<i>Harmon</i>	<i>miamiwiz</i>	<i>sympaaa</i>	<i>jec</i>
	Pass	1♦	Pass
Pass	Dbl	Rdbl	1 NT
Pass	Pass	Pass	

1 NT by South

<i>Trick</i>	<i>Lead</i>	<i>2nd</i>	<i>3rd</i>	<i>4th</i>
1. W	♥ 3	2	<u>K</u>	6
2. E	♥ 7	J	Q	<u>A</u>
3. N	♦ K	<u>A</u>	5	6
4. E	♦ 9	<u>10</u>	2	7
5. S	♣ 3	6	Q	<u>A</u>
6. E	♦ 4	<u>Q</u>	3	♠ 2
7. S	♦ J	♠ 8	♣ 4	8

Made 1 — NS +90

**Board 971**  
 East Deals  
 Both Vul

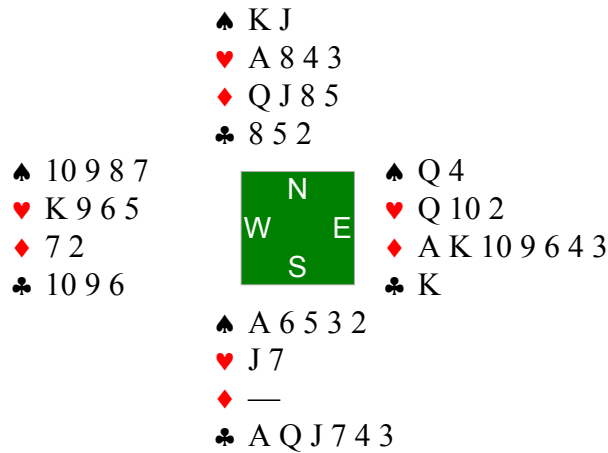

NS 6♣; NS 4♠; NS 3N; EW 2♦; NS 1♥; Par +1100: EW 6♦×-4

West	North	East	South
<i>Harmon</i>	<i>miamiwiz</i>	<i>sympaaa</i>	<i>jec</i>
		1♦	2♣
Pass	2 NT	Pass	3♠
Pass	3 NT	Pass	Pass

Pass

3 NT by North

<i>Trick</i>	<i>Lead</i>	<i>2nd</i>	<i>3rd</i>	<i>4th</i>
1. E	♦ <u>A</u>	♠ 2	7	8
2. E	♠ Q	3	10	<u>K</u>
3. N	♣ 5	K	<u>A</u>	10
4. S	♠ 5	7	<u>J</u>	4
5. N	♦ J	<u>K</u>	♥ 7	2
6. E	♦ 10	-	-	-

Made 5 — NS +660



**Board 980**  
 South Deals  
 Both Vul

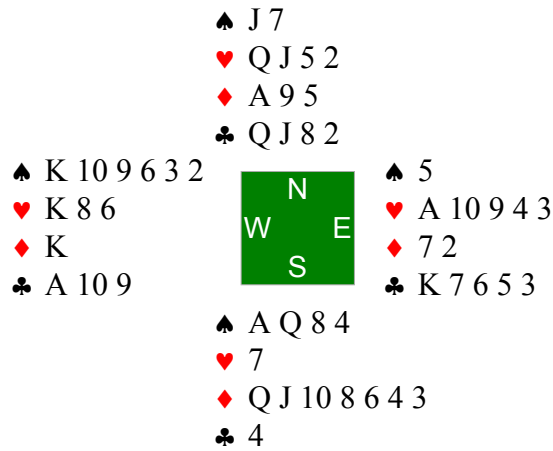

EW 3♥; NS 4♦; NS 2N; EW 2♠; EW 2♣; Par +130

West	North	East	South
<i>gunnarhall</i>	<i>smispi</i>	<i>mselfigman</i>	<i>jec</i>
			Pass
1 ♠	Pass	1 NT <sup>1</sup>	3 ♦
Pass	Pass	Pass	

1. f

3 ♦ by South

<i>Trick</i>	<i>Lead</i>	<i>2nd</i>	<i>3rd</i>	<i>4th</i>
1. W	♠ 10	<u>J</u>	5	4
2. N	♥ Q	<u>A</u>	7	6
3. E	♣ 7	4	<u>A</u>	2
4. W	♠ 9	7	<u>♦ 2</u>	8
5. E	♥ 4	<u>♦ 3</u>	8	2
6. S	♦ Q	K	<u>A</u>	7

Made 4 — NS +130

**Board 981**  
 West Deals  
 None Vul

♠ J 6 4 ♥ Q 7 6 ♦ K J 6 4 2 ♣ 8 6		♠ A 10 7 3 2 ♥ A 5 ♦ Q 10 9 8 7 ♣ 9	♠ K 9 8 5 ♥ J 9 2 ♦ A 5 ♣ Q J 7 5
♠ Q ♥ K 10 8 4 3 ♦ 3 ♣ A K 10 4 3 2			

NS 3♥; NS 2♠; NS 3♣; NS 1N; NS 2♦; Par +140

West	North	East	South
<i>gunnarhall</i>	<i>smispi</i>	<i>mselfigman</i>	<i>jec</i>
Pass	Pass	1 ♣	1 ♥
Pass	1 ♠	Pass	2 ♣
2 ♦	Dbl	Pass	3 ♣
Pass	Pass	Pass	

3 ♣ by South

<i>Trick</i>	<i>Lead</i>	<i>2nd</i>	<i>3rd</i>	<i>4th</i>
1. W	♣ 6	9	J	<u>K</u>
2. S	<u>♣ A</u>	8	♠ 2	5
3. S	♣ 2	♦ 2	♦ 7	<u>7</u>
4. E	<u>♦ A</u>	3	4	8
5. E	♠ 5	<u>Q</u>	6	3
6. S	♣ 3	♦ 6	♠ 7	<u>Q</u>
7. E	♠ 8	♥ 3	J	<u>A</u>
8. N	♠ 10	K	<u>♣ 4</u>	4
9. S	♥ 4	6	<u>A</u>	2
10. N	♥ 5	9	<u>K</u>	7
11. S	♥ 8	<u>Q</u>	♦ 9	J
12. W	♦ K	-	-	-

Made 3 — NS +110

**Board 983**  
 East Deals  
 Both Vul

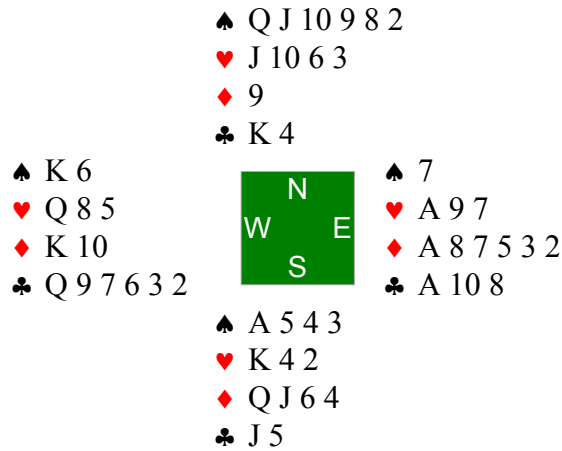

E 5♣; E 4♦; W 4♣; NS 2♠; W 3♦; EW 1N; E 1♥; Par -600

West	North	East	South
<i>gunnarhall</i>	<i>smispi</i>	<i>mselfigman</i>	<i>jec</i>
		1 ♦	Pass
1 NT	2 ♠	3 ♦	3 ♠
3 NT	Pass	Pass	Dbl
Pass	Pass	4 ♦	Pass
Pass	Pass		

4 ♦ by East

<i>Trick</i>	<i>Lead</i>	<i>2nd</i>	<i>3rd</i>	<i>4th</i>
1. S	♠ 4	<u>K</u>	9	7
2. W	♠ 6	2	<u>♦ 2</u>	3
3. E	♦ 3	4	<u>K</u>	9
4. W	♦ 10	♠ Q	<u>A</u>	6
5. E	<u>♣ A</u>	5	2	4
6. E	♣ 10	J	Q	<u>K</u>
7. N	♥ 3	7	<u>K</u>	5
8. S	♠ A	♣ 3	8	<u>♦ 5</u>

Down 1 — NS +100

**Board 997**  
 West Deals  
 Both Vul

♠ 9 6 4	♠ A K Q 7 2	♠ 10 5 3
♥ A K 8 5 3	♥ Q 9	♥ 10 7 4
♦ K Q J 10	♦ 8 4	♦ 6 5 3 2
♣ 6	♣ A K 9 3	♣ Q 10 5

♠ J 8
♥ J 6 2
♦ A 9 7
♣ J 8 7 4 2

NS 3♠; NS 4♣; NS 2N; EW 1♥; Par +140

West	North	East	South
<i>bareket</i>	<i>smispi</i>	<i>lengy</i>	<i>jec</i>
1♥	1♠	Pass	Pass
Pass			

1♠ by North

<i>Trick</i>	<i>Lead</i>	<i>2nd</i>	<i>3rd</i>	<i>4th</i>
1. E	♥ 4	2	<u>K</u>	9
2. W	♦ K	4	2	<u>A</u>
3. S	♠ J	4	2	3
4. S	♠ 8	6	<u>A</u>	5
5. N	♠ K	10	♦ 7	9
6. N	♣ K	5	2	6
7. N	♣ A	10	4	♥ 3
8. N	♣ 3	<u>Q</u>	7	♥ 5
9. E	♥ 10	6	<u>A</u>	Q
10. W	♦ Q	-	-	-
Made 3 — NS +140				

**Board 1003**  
 East Deals  
 Both Vul

	♠ A J 7 3		
	♥ K Q 6		
	♦ A 5 4		
	♣ Q 8 5		
♠ Q 10 5 4 ♥ A 9 ♦ 3 2 ♣ K J 10 9 3	<div style="display: inline-block; background-color: green; color: white; padding: 5px; border: 1px solid black;">       N W     E S     </div>	♠ K 9 8 6 2 ♥ 10 8 ♦ K 10 9 ♣ A 6 4	
	♠ —		
	♥ J 7 5 4 3 2		
	♦ Q J 8 7 6		
	♣ 7 2		

EW 4♠; NS 3♥; NS 3♦; E 3♣; W 2♣; Par -500: NS 5♦×-2;  
 NS 5♥×-2

West	North	East	South
<i>bareket</i>	<i>smispi</i>	<i>lengy</i>	<i>jec</i>
		Pass	Pass
1 ♣	1 NT	Dbl	Rdbl <sup>1</sup>
Pass	2 ♣ <sup>2</sup>	Dbl	2 ♥
Pass	Pass	2 ♠	3 ♦
Pass	3 ♥	Pass	Pass
3 ♠	Pass	Pass	Pass

1. forces 2c

2. forced

3 ♠ by East

<i>Trick</i>	<i>Lead</i>	<i>2nd</i>	<i>3rd</i>	<i>4th</i>
1. S	♦ Q	2	<u>A</u>	9
2. N	♥ K	8	7	<u>A</u>
3. W	♥ 9	<u>Q</u>	10	2
4. N	♦ 5	<u>K</u>	6	3
5. E	♠ 2	♥ 3	Q	<u>A</u>
6. N	♦ 4	10	J	<u>♠ 4</u>
7. W	♠ 10	J	<u>K</u>	♥ 4
8. E	<u>♠ 9</u>	♥ 5	5	3
9. E	<u>♠ 8</u>	♦ 7	♣ 3	7
10. E	♣ 4	7	<u>K</u>	5
11. W	<u>♣ J</u>	8	6	2

Made 4 — NS -170

**Board 1004**  
 South Deals  
 None Vul

♠ J 3 ♥ Q ♦ A J 9 8 6 5 3 ♣ Q 10 6	♠ A K Q 5 4 ♥ A K 6 4 3 ♦ Q 10 ♣ 2	<div style="background-color: green; color: white; padding: 5px; width: 40px; height: 40px; margin: 0 auto; display: flex; flex-direction: column; align-items: center; justify-content: center;"> <span>N</span> <span>W</span> <span>E</span> <span>S</span> </div>	♠ 10 9 7 2 ♥ J 9 8 7 ♦ — ♣ A K J 7 3
♠ 8 6 ♥ 10 5 2 ♦ K 7 4 2 ♣ 9 8 5 4			

NS 3♥; NS 2♠; W 1N; EW 2♦; EW 2♣; Par +140

West	North	East	South
<i>bareket</i>	<i>smispi</i>	<i>lengy</i>	<i>jec</i>
			Pass
3♦	4♦	Dbl	Pass
Pass	4♥	Dbl	Pass
Pass	Pass		

4♥× by North

Trick	Lead	2nd	3rd	4th
1. E	<u>♣ K</u>	4	6	2
2. E	<u>♣ A</u>	5	10	<u>♥ 3</u>
3. N	<u>♥ A</u>	7	2	Q
4. N	<u>♠ A</u>	2	6	3
5. N	<u>♠ K</u>	7	8	J
6. N	<u>♠ Q</u>	9	♦ 2	♦ 3
7. N	♠ 4	10	<u>♥ 5</u>	♦ 5
8. S	♣ 8	Q	<u>♥ 4</u>	3
9. N	♠ 5	<u>♥ J</u>	♦ 4	♦ 6
10. E	♥ 9	<u>10</u>	♦ 8	6
11. S	♦ 7	-	-	-

Down 1 — NS -100

**Board 1005**  
 West Deals  
 N-S Vul

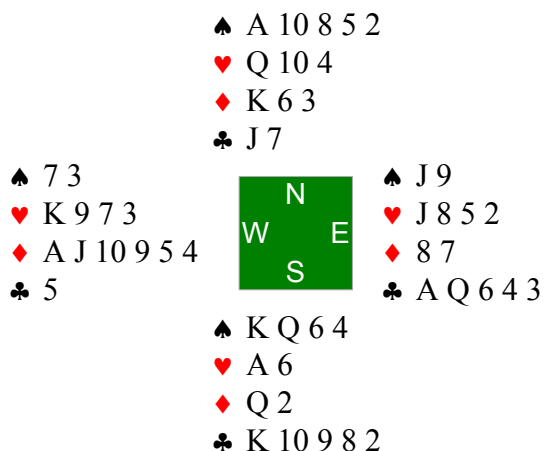

NS 4♠; NS 3N; NS 3♣; EW 2♦; EW 1♥; Par +500; EW 5♦×-3

West	North	East	South
<i>bareket</i>	<i>smispi</i>	<i>lengy</i>	<i>jec</i>
Pass	Pass	1 NT	2♠ <sup>1</sup>
Dbl <sup>2</sup>	4♠	Pass	Pass
5♦	Dbl	5♥	Dbl
Pass	Pass	Pass	

1. 4s longer minor

2. to

5♥× by East

Trick	Lead	2nd	3rd	4th
1. S	♠ K	3	8	9
2. S	♠ 4	7	<u>A</u>	J
3. N	♣ 7	<u>A</u>	2	5
4. E	♥ 2	6	<u>K</u>	4
5. W	♥ 3	10	5	<u>A</u>
6. S	♣ 8	♦ 4	J	<u>Q</u>
7. E	♦ 7	2	5	<u>K</u>
8. N	♥ Q	8	♣ 9	7
9. N	♠ 2	♥ J	6	♦ 9
10. E	♦ 8	Q	-	-

Down 3 — NS +500

**Board 1008**  
 South Deals  
 E-W Vul

♠ 9 7 ♥ K ♦ Q J 10 7 ♣ K Q 7 5 4 2	♠ Q 10 5 4 ♥ A J 10 9 2 ♦ K 9 6 ♣ A	<div style="background-color: green; color: white; padding: 5px; display: inline-block;">           N            W     E            S         </div>	♠ A 3 2 ♥ Q 6 5 3 ♦ A 8 5 ♣ 10 8 6
	♠ K J 8 6 ♥ 8 7 4 ♦ 4 3 2 ♣ J 9 3		

EW 4♣; EW 2N; N 2♥; EW 3♦; NS 1♠; S 1♥; Par -130

West	North	East	South
<i>svenja17</i>	<i>nevaio</i>	<i>HeBo</i>	<i>jec</i>
			Pass
1 ♣	1 ♥	Dbl	2 ♥
Pass	2 ♠	Dbl	Pass
3 ♣	Pass	Pass	Pass

3 ♣ by West

<i>Trick</i>	<i>Lead</i>	<i>2nd</i>	<i>3rd</i>	<i>4th</i>
1. N	♠ 5	<u>A</u>	8	7
2. E	♣ 6	3	Q	<u>A</u>
3. N	♠ 4	2	<u>K</u>	9
4. S	♠ 6	<u>♣ 7</u>	Q	3
5. W	<u>♣ K</u>	♥ 2	8	9
6. W	♦ Q	K	<u>A</u>	2
7. E	♦ 5	3	<u>10</u>	6
8. W	♦ J	9	8	4
9. W	♦ 7	-	-	-

Made 3 — NS -110



**Board 1011**  
 East Deals  
 E-W Vul

♠ K 10 6 4 3	♠ Q 8	♠ A J 9 5 2
♥ K 10 9 3	♥ Q J 5	♥ 7 6
♦ 2	♦ A J 8	♦ 10 7
♣ J 3 2	♣ K 9 8 6 5	♣ A Q 7 4
	♠ 7	
	♥ A 8 4 2	
	♦ K Q 9 6 5 4 3	
	♣ 10	

EW 4♠; NS 4♦; EW 2♣; NS 1♥; Par -100; NS 5♦×-1

West	North	East	South
<i>svenja17</i>	<i>nevaio</i>	<i>HeBo</i>	<i>jec</i>
		1 ♠	3 ♦
4 ♠	5 ♦	Pass	Pass
Dbl	Pass	Pass	Pass

5♦× by South

<i>Trick</i>	<i>Lead</i>	<i>2nd</i>	<i>3rd</i>	<i>4th</i>
1. W	♠ 3	8	<u>A</u>	7
2. E	♥ 7	<u>A</u>	3	5
3. S	♦ 3	2	<u>J</u>	7
4. N	♦ 8	10	<u>Q</u>	♠ 6
5. S	♥ 2	<u>K</u>	J	6
6. W	♠ K	Q	5	<u>♦ 4</u>
7. S	♣ 10	3	K	<u>A</u>

Down 1 — NS -100

**Board 1013**

West Deals  
None Vul

♠ A K 8 5 3 2	♠ 10 7	♠ Q J 6
♥ 10	♥ J 8 6 2	♥ K 9 5 3
♦ 10 9 7 5 4	♦ 6 3	♦ Q J 2
♣ 9	♣ A K 10 4 2	♣ 8 5 3

♠ 9 4
♥ A Q 7 4
♦ A K 8
♣ Q J 7 6

NS 5♥; NS 5♣; EW 2♠; EW 3♦; NS 1N; Par +450

West	North	East	South
<i>svenja17</i>	<i>nevaio</i>	<i>HeBo</i>	<i>jec</i>
2 ♠ <sup>1</sup>	Pass	Pass	Dbl
3 ♦	3 ♥	4 ♠	Pass
Pass	Pass		

1. sp and minor

4 ♠ by West

<i>Trick</i>	<i>Lead</i>	<i>2nd</i>	<i>3rd</i>	<i>4th</i>
1. N	<u>♣ A</u>	3	7	9
2. N	<u>♥ 6</u>	3	<u>Q</u>	10
3. S	<u>♦ K</u>	4	6	2
4. S	<u>♦ A</u>	5	3	J
5. S	<u>♦ 8</u>	7	<u>♠ 7</u>	Q
6. N	♣ K	-	-	-

Down 2 — NS +100

**Board 1015**  
 East Deals  
 Both Vul

♠ Q 6 2 ♥ 10 9 8 3 ♦ Q J 10 7 ♣ 10 6		♠ K 8 ♥ A K Q 7 6 ♦ 9 4 3 ♣ J 7 2	♠ 10 4 ♥ 2 ♦ A 6 5 2 ♣ A K Q 8 5 4
♠ A J 9 7 5 3 ♥ J 5 4 ♦ K 8 ♣ 9 3			

NS 3♠; NS 3♥; EW 3♦; EW 3♣; Par +140

West	North	East	South
<i>svenja17</i>	<i>nevaio</i>	<i>HeBo</i>	<i>jec</i>
		1 ♣	Pass
1 ♦	1 ♥	3 ♦	3 ♥
Pass	Pass	4 ♣	Pass
4 ♦	Pass	Pass	Pass

4♦ by West

<i>Trick</i>	<i>Lead</i>	<i>2nd</i>	<i>3rd</i>	<i>4th</i>
1. N	<u>♥ A</u>	2	4	3
2. N	<u>♠ K</u>	4	9	6
3. N	♠ 8	10	<u>A</u>	2
4. S	♠ 3	Q	♦ 9	<u>♦ A</u>
5. E	♦ 2	<u>K</u>	7	3
6. S	♠ 5	<u>♦ Q</u>	♥ 6	♣ 4
7. W	<u>♦ J</u>	4	5	8
8. W	♣ 10	2	<u>A</u>	3
9. E	<u>♣ K</u>	9	6	7
10. E	<u>♣ Q</u>	♠ 7	♥ 8	J
11. E	♣ 5	♥ 5	♦ 10	-

Down 1 — NS +100

**Board 1018**  
 North Deals  
 Both Vul

♠ A 8 5 4	♠ Q J 10 9	♠ 2
♥ J 4	♥ 7 6 2	♥ A Q 10 8 5 3
♦ A 10	♦ 9 7 4	♦ 6 5 3 2
♣ A 10 7 4 2	♣ J 9 6	♣ 5 3

♠ K 7 6 3	<table border="1" style="background-color: green; color: white; width: 40px; height: 40px; margin: auto;"> <tr><td style="text-align: center;">N</td></tr> <tr><td style="text-align: center;">W E</td></tr> <tr><td style="text-align: center;">S</td></tr> </table>	N	W E	S	♠ 2
N					
W E					
S					
♥ K 9		♥ A Q 10 8 5 3			
♦ K Q J 8		♦ 6 5 3 2			
♣ K Q 8		♣ 5 3			

E 4♥; W 3♥; EW 2N; NS 2♠; EW 1♣; Par -500: NS 4♠×-2

West	North	East	South
<i>svenja17</i>	<i>nevaio</i>	<i>HeBo</i>	<i>jec</i>
	Pass	2♦ <sup>1</sup>	2NT
3♥ <sup>2</sup>	Pass	Pass	Pass

1. Multi

2. poc

3♥ by West

Trick	Lead	2nd	3rd	4th
1. N	♠ Q	2	7	<u>A</u>
2. W	♣ 2	6	3	<u>8</u>
3. S	♦ K	10	4	2
4. S	♦ J	<u>A</u>	7	3
5. W	♣ A	9	5	Q
6. W	♠ 4	9	<u>♥ 3</u>	3
7. E	♦ 5	Q	<u>♥ 4</u>	9
8. W	♠ 5	10	<u>♥ 5</u>	6
9. E	♦ 6	8	<u>♥ J</u>	♣ J
10. W	♣ 4	♥ 6	<u>♥ 8</u>	K
11. E	♥ A	9	-	-

Made 4 — NS -170

**Board 1019**  
 East Deals  
 None Vul

	♠ A		
	♥ 7		
	♦ Q 9 8 4		
	♣ J 9 7 6 4 3 2		
♠ 9 7 5 4 2 ♥ 5 4 ♦ A J 6 3 ♣ 10 8	<div style="background-color: green; color: white; padding: 5px; display: inline-block;">           N            W     E                 S         </div>	♠ Q J 10 ♥ A K J 9 6 3 ♦ K 5 2 ♣ Q	
	♠ K 8 6 3		
	♥ Q 10 8 2		
	♦ 10 7		
	♣ A K 5		

NS 3N; NS 4♣; EW 2♠; EW 1♥; NS 1♦; Par +300; EW 4♠×-2

West	North	East	South
<i>svenja17</i>	<i>nevaio</i>	<i>HeBo</i>	<i>jec</i>
		1 ♥	Pass
1 ♠	3 ♣	Dbl	Pass
3 ♠	Pass	Pass	Pass

3 ♠ by West

<i>Trick</i>	<i>Lead</i>	<i>2nd</i>	<i>3rd</i>	<i>4th</i>
1. N	♣ 2	Q	<u>K</u>	8
2. S	♣ A	10	4	<u>♠ 10</u>
3. E	♠ J	3	2	<u>A</u>
4. N	♥ 7	<u>A</u>	2	5
5. E	♠ Q	<u>K</u>	4	♣ 3
6. S	♣ 5	<u>♠ 5</u>	7	♦ 2
7. W	♥ 4	♣ 6	<u>K</u>	8
8. E	<u>♦ K</u>	7	3	4
9. E	♦ 5	10	J	<u>Q</u>
10. N	♦ 9	♥ 3	<u>♠ 6</u>	6
11. S	♥ Q	<u>♠ 7</u>	♣ 9	6
12. W	<u>♠ 9</u>	♦ 8	♥ 9	8
13. W	<u>♦ A</u>	♣ J	♥ J	♥ 10

Down 1 — NS +50

**Board 1021**  
 West Deals  
 E-W Vul

♠ Q 7 4 ♥ K Q 5 4 ♦ A K 9 ♣ K 7 5		♠ K 10 8 ♥ 10 9 3 2 ♦ Q 2 ♣ A 10 9 6	♠ J 3 ♥ J 8 7 6 ♦ J 10 7 6 4 ♣ 8 3
♠ A 9 6 5 2 ♥ A ♦ 8 5 3 ♣ Q J 4 2			

NS 4♠; NS 4♣; EW 2♥; NS 1N; Par +420

West	North	East	South
<i>svenja17</i>	<i>nevaio</i>	<i>HeBo</i>	<i>jec</i>
1 ♣	Pass	1 ♦	1 ♠
Dbl	2 ♣	Pass	2 ♠
Pass	Pass	Pass	

2 ♠ by South

<i>Trick</i>	<i>Lead</i>	<i>2nd</i>	<i>3rd</i>	<i>4th</i>
1. W	<u>♦ A</u>	2	J	3
2. W	<u>♦ K</u>	Q	6	8
3. W	<u>♥ K</u>	2	6	<u>A</u>
4. S	<u>♦ 5</u>	9	<u>♠ 8</u>	4
5. N	<u>♠ K</u>	3	2	4
6. N	<u>♠ 10</u>	J	<u>A</u>	7
7. S	<u>♣ Q</u>	K	-	-

Made 4 — NS +170

**Board 1025**  
 West Deals  
 Both Vul

♠ K Q 3 2 ♥ J 9 8 4 ♦ A 8 7 4 ♣ 5	<div style="border: 1px solid black; width: 40px; height: 40px; margin: 0 auto; background-color: #006400; color: white; display: flex; flex-direction: column; align-items: center; justify-content: center;"> <div style="margin-bottom: 5px;">N</div> <div style="margin-bottom: 5px;">W</div> <div style="margin-bottom: 5px;">S</div> <div style="margin-bottom: 5px;">E</div> </div>	♠ 8 4 ♥ 10 5 ♦ K J 9 ♣ Q J 10 9 4 2	♠ J 10 7 5 ♥ A Q 3 2 ♦ 10 ♣ A 8 7 6
♠ A 9 6 ♥ K 7 6 ♦ Q 6 5 3 2 ♣ K 3			

E 4♠; E 4♥; W 3♠; W 3♥; NS 1♦; NS 1♣; Par -620

West	North	East	South
<i>svenja17</i>	<i>nevaio</i>	<i>HeBo</i>	<i>jec</i>
Pass	Pass	1 ♣	Dbl
1 ♥	Pass	2 ♥	Pass
Pass	3 ♣	Pass	Pass
3 ♥	Pass	Pass	Pass

3 ♥ by West

<i>Trick</i>	<i>Lead</i>	<i>2nd</i>	<i>3rd</i>	<i>4th</i>
1. N	♠ 8	5	9	<u>K</u>
2. W	♥ 4	5	<u>A</u>	7
3. E	♥ 2	<u>K</u>	8	10
4. S	♥ 6	<u>9</u>	♣ 4	3
5. W	♠ 2	4	J	<u>A</u>
6. S	♠ 6	3	♣ 2	<u>10</u>
7. E	♠ 7	♦ 2	<u>Q</u>	♦ 9
8. W	♦ <u>A</u>	J	10	3
9. W	♣ 5	9	<u>A</u>	K

Made 3 — NS -140

**Board 1026**  
 North Deals  
 N-S Vul

<p>♠ —          ♥ K Q J 9 4          ♦ K 9 6 4 3          ♣ 7 5 2</p>		<p>♠ Q J 10 8 3          ♥ 10 6 3          ♦ 10          ♣ J 9 6 3</p>	<p>♠ K 6 5 4 2          ♥ 8 2          ♦ Q 8 5          ♣ A K 8</p>
		<p>♠ A 9 7          ♥ A 7 5          ♦ A J 7 2          ♣ Q 10 4</p>	

EW 4♦; NS 2♠; EW 2♥; EW 1N; NS 1♣; Par -130

West	North	East	South
<i>svenja17</i>	<i>nevaio</i>	<i>HeBo</i>	<i>jec</i>
	Pass	1 ♠	Dbl
Pass	2 ♣	Pass	Pass
Dbl <sup>1</sup>	Pass	2 ♦	Pass
Pass	Pass		

1. to

2 ♦ by East

<i>Trick</i>	<i>Lead</i>	<i>2nd</i>	<i>3rd</i>	<i>4th</i>
1. S	♣ 4	2	J	<u>A</u>
2. E	♥ 8	5	<u>J</u>	3
3. W	♦ 3	10	Q	<u>A</u>
4. S	♣ Q	5	3	<u>K</u>
5. E	♥ 2	<u>A</u>	4	6
6. S	<u>♣ 10</u>	7	6	8
7. S	♥ 7	9	10	<u>♦ 5</u>
8. E	♦ 8	2	<u>9</u>	♠ 8
9. W	♦ K	-	-	-

Made 3 — NS -110



**Board 1027**  
 East Deals  
 E-W Vul

♠ Q 10 8 ♥ K 10 ♦ 10 6 3 ♣ 10 9 5 4 2	♠ A K 3 2 ♥ 9 5 ♦ A K 8 7 4 ♣ K 6		♠ J 5 ♥ A Q 8 7 4 3 ♦ J 9 5 ♣ 8 7
♠ 9 7 6 4 ♥ J 6 2 ♦ Q 2 ♣ A Q J 3			

NS 4♠; NS 4♦; NS 3♣; NS 1N; NS 1♥; Par +420

West	North	East	South
<i>svenja17</i>	<i>nevaio</i>	<i>HeBo</i>	<i>jec</i>
		2♦ <sup>1</sup>	Pass
2♥	Dbl	Pass	2♠
Pass	3♥ <sup>2</sup>	Pass <sup>3</sup>	4♠
Pass	Pass	Pass	

1. Multi
2. cue
3. good suit

4♠ by South

Trick	Lead	2nd	3rd	4th
1. W	♥ <u>K</u>	5	3	2
2. W	♥ 10	9	<u>A</u>	J
3. E	♥ Q	6	♦ 6	<u>♠ 2</u>
4. N	<u>♠ A</u>	5	4	8
5. N	<u>♠ K</u>	J	6	10

Made 4 — NS +420

**Board 1029**  
 West Deals  
 None Vul

♠ A 6 ♥ A Q 6 4 3 ♦ Q 10 9 ♣ 8 6 4		♠ J 8 5 ♥ 10 9 ♦ 6 4 ♣ A Q J 9 7 5	♠ Q 10 9 ♥ J 7 2 ♦ A J 8 5 2 ♣ 10 3
♠ K 7 4 3 2 ♥ K 8 5 ♦ K 7 3 ♣ K 2			

NS 2♠; EW 2♥; EW 3♦; NS 1N; NS 2♣; Par -100; NS 3♠×-1

West	North	East	South
<i>svenja17</i>	<i>nevaio</i>	<i>HeBo</i>	<i>jec</i>
1 ♥	Pass	2 ♥	2 ♠
Pass	3 ♥	Dbl <sup>1</sup>	3 ♠
Pass	Pass	Pass	

1. bad ♥

3 ♠ by South

<i>Trick</i>	<i>Lead</i>	<i>2nd</i>	<i>3rd</i>	<i>4th</i>
1. W	♣ 4	5	3	<u>K</u>
2. S	♠ 2	6	J	<u>Q</u>
3. E	♥ J	K	<u>A</u>	9
4. W	♥ <u>Q</u>	10	7	5
5. W	♣ 6	<u>A</u>	10	2
6. N	♣ <u>Q</u>	♦ 5	♦ 3	8
7. N	♦ 4	<u>A</u>	7	10
8. E	♦ 2	<u>K</u>	9	6
9. S	♥ 8	3	♠ <u>5</u>	2
10. N	♠ 8	10	3	<u>A</u>
11. W	♦ Q	-	-	-

Down 1 — NS -50

**Board 1038**  
 North Deals  
 N-S Vul

♠ K 9 8 5	♠ 10 7 6 4 3 2	♠ A J
♥ A 7 4	♥ J 6 2	♥ Q 9 3
♦ J 9 6	♦ 10	♦ 7 5 2
♣ Q 9 8	♣ 10 4 2	♣ A K J 7 3
	<div style="display: inline-block; background-color: green; color: white; padding: 5px; text-align: center; margin: 5px;">       N W     E S     </div>	
	♠ Q	
	♥ K 10 8 5	
	♦ A K Q 8 4 3	
	♣ 6 5	

EW 3♣; EW 1N; NS 2♦; Par -110

West	North	East	South
<i>lcy</i>	<i>miamiwiz</i>	<i>krobono</i>	<i>jec</i>
	Pass	1 NT <sup>1</sup>	2 NT <sup>2</sup>
3 NT	Pass	Pass	Pass

1. 15-17

2. 4h, longer minor

3 NT by East

<i>Trick</i>	<i>Lead</i>	<i>2nd</i>	<i>3rd</i>	<i>4th</i>
1. S	♦ <u>A</u>	6	10	2
2. S	♦ <u>K</u>	9	♠ 2	5
3. S	♦ <u>Q</u>	J	♣ 2	7
4. S	♦ 8	-	-	-

Down 2 — NS +100

**Board 1041**  
 West Deals  
 None Vul

♠ A Q 9 6 4 2	♠ J 8	♠ 7 3
♥ 6 3 2	♥ A Q 10 8 4	♥ J 9
♦ 9	♦ A Q 10 2	♦ J 6 4 3
♣ A 6 2	♣ J 8	♣ K Q 9 5 4
	<div style="display: inline-block; background-color: #006400; color: white; padding: 5px; text-align: center; border: 1px solid black;">             N              W     E              S           </div>	
	♠ K 10 5	
	♥ K 7 5	
	♦ K 8 7 5	
	♣ 10 7 3	

EW 3♠; NS 3♥; NS 3♦; EW 2♣; Par -100: NS 4♦×-1; NS 4♥×-1

West	North	East	South
<i>lcy</i>	<i>miamiwiz</i>	<i>krobono</i>	<i>jec</i>
1 ♠	2 ♥	Pass	2 NT
Pass	3 NT	Pass	Pass

Pass

3 NT by South

<i>Trick</i>	<i>Lead</i>	<i>2nd</i>	<i>3rd</i>	<i>4th</i>
1. W	♦ 9	10	J	<u>K</u>
2. S	♦ 5	♠ 2	<u>A</u>	3
3. N	♦ <u>Q</u>	4	7	♥ 3
4. N	♦ 2	6	<u>8</u>	♠ 4
5. S	♥ 5	2	<u>Q</u>	9
6. N	♥ 4	J	<u>K</u>	6
7. S	♥ 7	♠ 6	<u>A</u>	♣ 4

Made 3 — NS +400

**Board 1048**  
 South Deals  
 N-S Vul

♠ A Q J 6 4	♠ K 9 8	♠ 10 3
♥ 4	♥ A K 10 9 6 2	♥ J 8 7
♦ A J 9 6	♦ 8 3 2	♦ K Q 7
♣ A 10 5	♣ 8	♣ Q 6 4 3 2

♠ 7 5 2
♥ Q 5 3
♦ 10 5 4
♣ K J 9 7

E 4♠; W 3♠; E 4♦; W 3♦; EW 3♣; NS 1N; NS 1♥; Par -420

West	North	East	South
<i>lcy</i>	<i>miamiwiz</i>	<i>krobono</i>	<i>jec</i>
			Pass
1 ♠	2 ♥	Pass	3 ♥
Dbl	Pass	5 ♣	Pass
Pass	Pass		

5 ♣ by East

Trick	Lead	2nd	3rd	4th
1. S	♥ 3	4	<u>A</u>	8
2. N	♥ K	7	5	<u>♣ 5</u>
3. W	♦ 6	2	<u>K</u>	4
4. E	♠ 10	2	4	<u>K</u>
5. N	♥ 10	J	Q	<u>♣ 10</u>
6. W	<u>♣ A</u>	8	2	7
7. W	♦ 9	3	<u>Q</u>	5
8. E	♣ 3	-	-	-

Down 3 — NS +150

**Board 1051**  
 East Deals  
 N-S Vul

♠ 5 ♥ J 10 7 4 ♦ 9 4 3 2 ♣ Q 8 6 4		♠ Q J 10 9 8 ♥ K Q 9 6 ♦ 8 ♣ A K 9	♠ A 7 4 3 2 ♥ A 5 3 2 ♦ K 10 ♣ 5 3
♠ K 6 ♥ 8 ♦ A Q J 7 6 5 ♣ J 10 7 2			

NS 5N; NS 4♠; NS 2♥; NS 3♦; NS 3♣; Par +660

West	North	East	South
<i>lcy</i>	<i>miamiwiz</i>	<i>krobono</i>	<i>jec</i>
		1 ♠	Pass
Pass	1 NT	Pass	3 NT
Pass	Pass	Pass	

3 NT by North

<i>Trick</i>	<i>Lead</i>	<i>2nd</i>	<i>3rd</i>	<i>4th</i>
1. E	♠ 3	<u>K</u>	5	8
2. S	♠ 6	♣ 6	J	<u>A</u>
3. E	♥ <u>A</u>	8	7	6
4. E	♥ 2	♦ 5	10	<u>K</u>
5. N	♠ <u>Q</u>	2	♦ 6	♦ 2
6. N	♠ <u>10</u>	4	♣ 2	♦ 3
7. N	♠ 9	7	♦ 7	♦ 4
8. N	♥ <u>Q</u>	3	♣ J	4
9. N	♣ <u>A</u>	3	7	4
10. N	♣ <u>K</u>	5	10	8
11. N	♦ 8	10	<u>A</u>	9
12. S	♦ Q	♣ Q	♥ 9	<u>K</u>
13. E	♥ 5	♦ J	<u>J</u>	♣ 9

Made 3 — NS +600

**Board 1052**  
 South Deals  
 E-W Vul

♠ A K J 3	<div style="display: inline-block; background-color: green; color: white; padding: 10px; border: 1px solid black;">           N W     E S         </div>	♠ Q 10
♥ 8 3		♥ Q 9 7 5
♦ A Q J 7 6 4		♦ K 8 3
♣ 9		♣ K 4 3 2

♠ 9 8 7 5 4 2  
 ♥ A 2  
 ♦ 10 9 2  
 ♣ 10 8

E 4N; W 3N; EW 4♦; E 2♠; NS 3♣; W 1♠; NS 1♥; Par -300:  
 NS 5♣×-2

West	North	East	South
<i>lcy</i>	<i>miamiwiz</i>	<i>krobono</i>	<i>jec</i>
			Pass
1 ♦	2 NT	Dbl	Pass
Pass	3 ♣	Dbl	Pass
Pass	Pass		

3 ♣× by North

<i>Trick</i>	<i>Lead</i>	<i>2nd</i>	<i>3rd</i>	<i>4th</i>
1. E	♦ 3	2	<u>A</u>	5
2. W	♦ Q	<u>♣ 5</u>	8	9
3. N	♥ 4	5	<u>A</u>	3
4. S	♥ 2	8	<u>K</u>	7
5. N	♥ J	9	♣ 8	<u>♣ 9</u>
6. W	♠ 3	6	<u>10</u>	2
7. E	♣ 2	<u>10</u>	♦ 6	6
8. S	♠ 4	K	♣ 7	Q
9. N	♥ 10	Q	♠ 5	♦ 4
10. E	♦ K	10	7	<u>♣ J</u>
11. N	♥ 6	<u>♣ 3</u>	♠ 7	♠ J
12. E	♣ 4	♠ 8	♠ A	<u>Q</u>
13. N	♣ A	K	♠ 9	♦ J

Down 1 — NS -100

**Board 1053**

West Deals  
Both Vul

♠ A Q 2	♠ J 10 9 6 3	♠ K 4
♥ 9 8 7 2	♥ A J	♥ Q 10 6
♦ A K 10 5	♦ 7 6	♦ 9 8 4 3
♣ 7 6	♣ K Q 3 2	♣ A J 9 8

♠ 8 7 5
♥ K 5 4 3
♦ Q J 2
♣ 10 5 4

E 4N; EW 4♥; W 3N; EW 3♦; EW 3♣; EW 1♠; Par -630

West	North	East	South
<i>lcy</i>	<i>miamiwiz</i>	<i>krobono</i>	<i>jec</i>
1 ♦	1 ♠	1 NT	2 ♠
Pass	Pass	3 ♦	Pass
Pass	Pass		

3 ♦ by West

<i>Trick</i>	<i>Lead</i>	<i>2nd</i>	<i>3rd</i>	<i>4th</i>
1. N	♠ J	4	5	<u>Q</u>
2. W	<u>♦ A</u>	6	3	2
3. W	<u>♦ K</u>	7	4	J
4. W	♥ 9	<u>A</u>	6	4
5. N	♠ 6	<u>K</u>	8	2
6. E	♦ 8	<u>Q</u>	5	♠ 3
7. S	<u>♥ K</u>	2	J	10
8. S	♥ 3	7	♣ 3	<u>Q</u>

Made 3 — NS -110



**Board 1056**  
 South Deals  
 Both Vul

♠ 10 7 5 ♥ 10 7 4 ♦ J 10 9 8 ♣ A K 8		♠ Q 9 8 6 4 3 ♥ A J 8 ♦ Q ♣ J 9 2	♠ A K J ♥ K 5 2 ♦ A K 5 4 2 ♣ 7 4
♠ 2 ♥ Q 9 6 3 ♦ 7 6 3 ♣ Q 10 6 5 3			

EW 5N; EW 5♦; EW 2♥; EW 1♠; EW 1♣; Par -660

West	North	East	South
<i>lcy</i>	<i>miamiwiz</i>	<i>krobono</i>	<i>jec</i>
Pass	Pass	1♦	Pass
1 NT	2♠	3 NT	Pass
Pass	Pass		

3 NT by West

Trick	Lead	2nd	3rd	4th
1. N	♠ 6	<u>A</u>	2	5
2. E	♦ <u>A</u>	3	8	Q
3. E	♦ 2	6	<u>9</u>	♠ 9
4. W	♦ <u>10</u>	♠ 3	4	7
5. W	♦ <u>J</u>	♣ 2	5	♣ 3
6. W	♠ 7	4	<u>J</u>	♣ 5
7. E	♦ <u>K</u>	♥ 3	♥ 4	♥ 8
8. E	♠ <u>K</u>	♥ 6	10	Q
9. E	♣ 4	6	<u>A</u>	9
10. W	♥ 7	<u>A</u>	2	9
11. N	♠ 8	♥ 5	♥ Q	♣ 8
12. N	♣ J	-	-	-

Made 5 — NS -660

**Board 1057**  
 West Deals  
 None Vul

♠ J 10 7 4 3	♠ A Q	♠ K 6 2
♥ A Q 10 5	♥ K 9 7 3	♥ 8 6
♦ Q 5	♦ J 10 4 2	♦ 8 7 3
♣ Q 4	♣ K J 9	♣ 8 7 6 3 2

♠ 9 8 5
♥ J 4 2
♦ A K 9 6
♣ A 10 5

N 3N; NS 3♥; NS 4♦; S 2N; NS 2♣; NS 1♠; Par +400

West	North	East	South
<i>lcy</i>	<i>miamiwiz</i>	<i>krobono</i>	<i>jec</i>
1 ♠	Dbl	Pass	2 ♠
Pass	2 NT	Pass	3 NT
Pass	Pass	Pass	

3 NT by North

<i>Trick</i>	<i>Lead</i>	<i>2nd</i>	<i>3rd</i>	<i>4th</i>
1. E	♠ 2	5	10	<u>Q</u>
2. N	♦ 2	8	<u>A</u>	5
3. S	♥ 2	10	<u>K</u>	6
4. N	♦ J	3	6	<u>Q</u>
5. W	♠ 3	<u>A</u>	K	8
6. N	♦ 4	7	<u>K</u>	♥ 5
7. S	♦ 9	♥ Q	<u>10</u>	♣ 6
8. N	♣ <u>K</u>	2	10	4
9. N	♣ J	3	5	<u>Q</u>

Down 2 — NS -100

**Board 1058**  
 North Deals  
 E-W Vul

♠ K J 10 7 4	♠ 9 8 5 3	♠ 6
♥ 4	♥ Q 9 5 3	♥ A J 10 8 7 2
♦ Q J 10 9 4	♦ A 5 2	♦ K 6 3
♣ K J	♣ 7 5	♣ 6 4 3

N	
W	E
S	

♠ A Q 2
♥ K 6
♦ 8 7
♣ A Q 10 9 8 2

EW 3♦; NS 1N; NS 2♣; EW 1♠; EW 1♥; Par -110

West	North	East	South
<i>lcy</i>	<i>miamiwiz</i>	<i>krobono</i>	<i>jec</i>
	Pass	2♥	2NT
Pass	Pass	Pass	

2 NT by South

Trick	Lead	2nd	3rd	4th
1. W	♦ Q	2	3	7
2. W	♦ J	5	<u>K</u>	8
3. E	♦ 6	♠ 2	4	<u>A</u>
4. N	♣ 5	6	8	<u>J</u>
5. W	♦ 10	♠ 3	♥ 2	♥ 6
6. W	♦ 9	♠ 5	♥ 8	♣ 2
7. W	♥ 4	3	<u>A</u>	K
8. E	♠ 6	<u>A</u>	4	8
9. S	♣ A	K	7	4
10. S	♣ Q	♠ 7	♥ 5	3

Down 2 — NS -100

**Board 1060**  
 South Deals  
 None Vul

♠ A 5	♠ K 10 9 8	♠ 7 6 4
♥ A K Q J 8 7 3	♥ 10 4	♥ 9 6 5 2
♦ J 9 8	♦ A K 3	♦ Q 6 5 2
♣ 4	♣ A 10 9 2	♣ J 7

N	
W	E
S	

♠ Q J 3 2
♥ —
♦ 10 7 4
♣ K Q 8 6 5 3

NS 6♠; NS 5♣; EW 3♥; NS 1♦; Par +800; EW 7♥×-4

West	North	East	South
<i>lcy</i>	<i>miamiwiz</i>	<i>krobono</i>	<i>jec</i>
			Pass
4♥	Dbl	5♥	6♣
Pass	Pass	Pass	

6♣ by South

<i>Trick</i>	<i>Lead</i>	<i>2nd</i>	<i>3rd</i>	<i>4th</i>
1. W	♥ A	4	2	<u>♣ 3</u>
2. S	♣ K	4	2	7
3. S	♣ 5	♥ 7	<u>A</u>	J
4. N	♥ 10	5	<u>♣ 6</u>	J
5. S	♠ J	<u>A</u>	8	4
6. W	♠ 5	<u>9</u>	6	2
7. N	♦ A	2	4	8
8. N	♦ K	5	7	9

Down 1 — NS -50

**Board 1061**  
 West Deals  
 N-S Vul

♠ J 10 8 7 4 3	<div style="display: inline-block; background-color: green; color: white; padding: 10px; border: 1px solid black;">           N W     E S         </div>	♠ A K 9
♥ J 10		♥ 9 3
♦ K 6 2		♦ Q 10 9 3
♣ K 4		♣ A Q 10 2

♠ 2  
 ♥ K Q 7  
 ♦ A J 7 5 4  
 ♣ J 9 7 6

NS 2♥; N 1N; EW 2♦; EW 1♠; Par +100: EW 2♠×-1; EW 3♦×-1

West	North	East	South
<i>lcy</i>	<i>miamiwiz</i>	<i>krobono</i>	<i>jec</i>
Pass	Pass	1 NT	Pass
2♥	Dbl	2♠	3♥
3♠	Pass	Pass	Pass

3♠ by East

<i>Trick</i>	<i>Lead</i>	<i>2nd</i>	<i>3rd</i>	<i>4th</i>
1. S	♥ K	10	<u>A</u>	3
2. N	♦ 8	10	<u>A</u>	2
3. S	♦ J	6	<u>♠ 6</u>	3
4. N	♥ 6	9	<u>Q</u>	J
5. S	♦ 5	K	<u>♠ 5</u>	9
6. N	♣ 8	-	-	-

Down 1 — NS +50

**Board 1063**

East Deals  
N-S Vul

<p>♠ Q 9 7 ♥ 9 7 ♦ Q 9 7 4 ♣ 10 6 4 2</p>		<p>♠ 10 6 5 3 ♥ A Q ♦ A K 8 ♣ A K Q J</p>	<p>♠ K ♥ 8 5 4 3 2 ♦ J 6 5 3 2 ♣ 8 7</p>
		<p>♠ A J 8 4 2 ♥ K J 10 6 ♦ 10 ♣ 9 5 3</p>	

NS 6N; NS 6♠; NS 6♣; NS 4♥; NS 2♦; Par +1440

West	North	East	South
<i>susan_2</i>	<i>smispi</i>	<i>batman98</i>	<i>jec</i>
		Pass	Pass
1 ♦ <sup>1</sup>	Dbl	1 ♥	1 ♠
Pass	2 ♦	Dbl	2 ♥
Pass	6 NT	Pass	Pass
Pass			

1. 0-6 or 12+

6 NT by North

<i>Trick</i>	<i>Lead</i>	<i>2nd</i>	<i>3rd</i>	<i>4th</i>
1. E	♦ 2	10	Q	<u>A</u>
2. N	♠ 3	K	<u>A</u>	7
3. S	♠ 2	Q	-	-

Made 6 — NS +1440

**Board 1067**  
 East Deals  
 E-W Vul

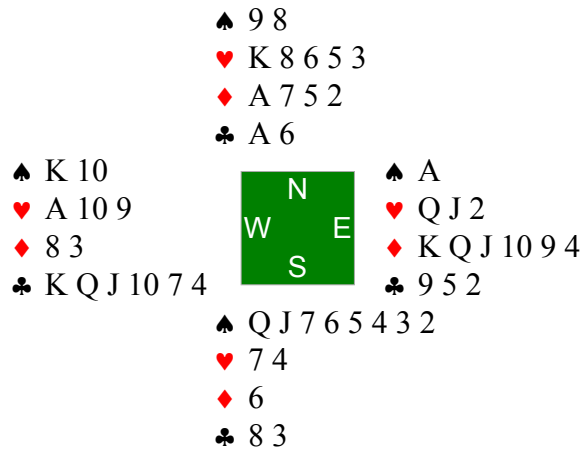

W 5N; E 3N; W 5♦; NS 3♠; E 4♦; EW 3♣; EW 1♥; Par -500:  
 NS 6♠×-3

West	North	East	South
<i>susan_2</i>	<i>smispi</i>	<i>batman98</i>	<i>jec</i>
		1 ♦	3 ♠
3 NT	4 ♥	Dbl	Pass
Pass	4 ♠	Dbl	Pass
Pass	Pass		

4 ♠× by South

<i>Trick</i>	<i>Lead</i>	<i>2nd</i>	<i>3rd</i>	<i>4th</i>
1. W	♣ K	<u>A</u>	2	8
2. N	♠ 8	<u>A</u>	2	10
3. E	♣ 9	3	<u>J</u>	6
4. W	<u>♠ K</u>	9	♦ K	3
5. W	♦ 8	<u>A</u>	4	6
6. N	♦ 2	9	<u>♠ 4</u>	3
7. S	<u>♠ Q</u>	♣ 4	♥ 3	♣ 5
8. S	♥ 4	<u>A</u>	5	2
9. W	♣ Q	-	-	-

Down 1 — NS -100

**Board 1069**

West Deals  
None Vul

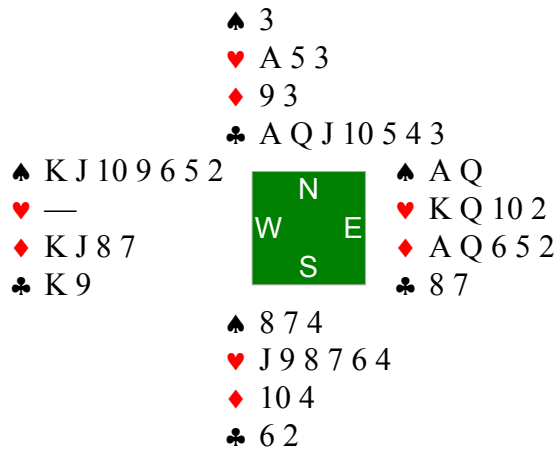

W 6♠; W 6♦; W 5N; E 5♠; E 5♦; NS 2♣; W 1♥; Par -980

West	North	East	South
<i>susan_2</i>	<i>smispi</i>	<i>batman98</i>	<i>jec</i>
1 ♠	2 ♣	2 ♦	Pass
2 ♠	4 ♣	5 ♠	Pass
6 ♠	Pass	Pass	Pass

6 ♠ by West

<i>Trick</i>	<i>Lead</i>	<i>2nd</i>	<i>3rd</i>	<i>4th</i>
1. N	♥ A	2	4	<u>♠ 2</u>

Made 7 — NS -1010



**Board 1073**  
 West Deals  
 N-S Vul

♠ A Q 7 6	♠ K J 9 3 2	♠ 10 4
♥ A 2	♥ Q J 9 7 4	♥ 10 6 3
♦ Q J 10 8 3	♦ 7	♦ 9 6 5 4
♣ 5 4	♣ Q 7	♣ A 9 8 2

♠ 8 5
♥ K 8 5
♦ A K 2
♣ K J 10 6 3

NS 4♥; NS 3♠; NS 3♣; NS 1N; EW 1♦; Par +620

West	North	East	South
<i>susan_2</i>	<i>smispi</i>	<i>batman98</i>	<i>jec</i>
1♦	2♦	Pass	4♥
Pass	Pass	Pass	

4♥ by South

<i>Trick</i>	<i>Lead</i>	<i>2nd</i>	<i>3rd</i>	<i>4th</i>
1. W	♦ Q	7	6	<u>A</u>
2. S	♣ 3	5	Q	<u>A</u>
3. E	♠ 4	5	<u>A</u>	2
4. W	♠ 6	<u>K</u>	10	8
5. N	♥ J	3	5	<u>A</u>
6. W	♠ 7	9	♥ 10	<u>♥ K</u>
7. S	♥ 8	2	Q	6
8. N	<u>♥ 9</u>	♦ 4	♦ 2	♦ 3
9. N	<u>♥ 7</u>	♦ 5	♣ 6	♦ 8

Made 4 — NS +620

**Board 1075**  
 East Deals  
 None Vul

♠ 4 3 2		♠ A K Q 8 7
♥ A K 8 7 4 2		♥ J
♦ 6 5		♦ A Q 8 3
♣ 8 7		♣ A 10 3
	<div style="display: inline-block; background-color: #008000; color: white; padding: 5px; border: 1px solid black;">           N            W     E            S         </div>	
		♠ 9 6 5
		♥ 10 5
		♦ K J 4 2
		♣ 9 6 4 2
		♠ J 10
		♥ Q 9 6 3
		♦ 10 9 7
		♣ K Q J 5

NS 5♠; NS 4N; N 5♣; NS 4♦; S 4♣; NS 2♥; Par +450

West	North	East	South
<i>susan_2</i>	<i>smispi</i>	<i>batman98</i>	<i>jec</i>
		Pass	Pass
2♥	Dbl	Pass	3♣
Pass	3♠	Pass	4♠
Pass	Pass	Pass	

4♠ by North

<i>Trick</i>	<i>Lead</i>	<i>2nd</i>	<i>3rd</i>	<i>4th</i>
1. E	♥ 10	3	<u>K</u>	J
2. W	♦ 6	3	<u>J</u>	7
3. E	♥ 5	9	A	<u>♠ 7</u>
4. N	♠ 8	5	<u>10</u>	3
5. S	♠ J	4	<u>A</u>	6

Made 5 — NS +450

**Board 1078**  
 North Deals  
 None Vul

♠ 10 6 ♥ A 6 5 4 ♦ Q J 5 2 ♣ J 5 3		♠ K 8 7 4 ♥ K 10 8 ♦ 8 6 ♣ K 10 8 6	♠ A 5 3 ♥ Q J 9 7 3 2 ♦ K 7 ♣ A 9
		♠ Q J 9 2 ♥ — ♦ A 10 9 4 3 ♣ Q 7 4 2	

NS 3♠; EW 3♥; NS 3♣; EW 1N; NS 1♦; Par +100: EW 4♥×-1

West	North	East	South
<i>susan_2</i>	<i>smispi</i>	<i>batman98</i>	<i>jec</i>
	Pass	1♥	Dbl
3♣	3♠	Pass	4♠
Pass	Pass	Pass	

4♠ by North

<i>Trick</i>	<i>Lead</i>	<i>2nd</i>	<i>3rd</i>	<i>4th</i>
1. E	♥ Q	♠ 2	5	10
2. S	♣ 2	3	10	<u>A</u>
3. E	♠ A	9	6	4
4. E	♠ 3	J	10	<u>K</u>
5. N	♦ 8	7	3	<u>Q</u>
6. W	♥ 4	<u>K</u>	2	♦ 4
7. N	♥ 8	9	♠ Q	6
8. S	♣ 4	5	<u>K</u>	9
9. N	♠ 8	5	-	-

Made 4 — NS +420

**Board 1089**

West Deals  
None Vul

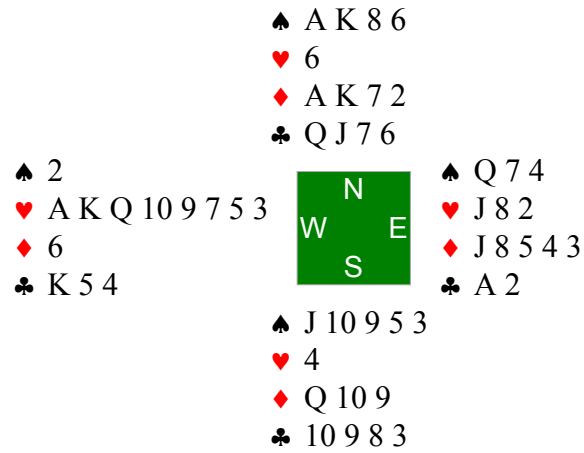

EW 5♥; NS 3♠; EW 1N; NS 2♣; NS 1♦; Par -300: NS 5♠×-2

West	North	East	South
<i>abc36</i>	<i>smispi</i>	<i>stewball</i>	<i>jec</i>
4♥	Dbl	Pass	4♠
5♥	5♠	6♥	Pass
Pass	Dbl	Pass	Pass

Pass

6♥× by West

<i>Trick</i>	<i>Lead</i>	<i>2nd</i>	<i>3rd</i>	<i>4th</i>
1. N	<u>♦ A</u>	3	9	6
2. N	<u>♠ A</u>	4	3	2
3. N	♦ K	-	-	-

Down 1 — NS +100

**Board 1093**  
 West Deals  
 N-S Vul

♠ —	♠ Q 9 7 5 4 3	♠ K J 10 8 2
♥ K J 9 6 4 2	♥ 8	♥ A 7 3
♦ K 9 4	♦ J 10	♦ Q 7 3
♣ Q J 9 4	♣ A K 5 2	♣ 7 6
	<div style="display: inline-block; background-color: green; color: white; padding: 5px; text-align: center; margin: 5px;">             N              W     E              S           </div>	
	♠ A 6	
	♥ Q 10 5	
	♦ A 8 6 5 2	
	♣ 10 8 3	

EW 4♥; EW 2N; EW 2♣; NS 1♠; NS 1♦; Par -420

West	North	East	South
<i>abc36</i>	<i>smispi</i>	<i>stewball</i>	<i>jec</i>
2♥	2♠	3♥	3♠
4♥	Pass	Pass	Pass

4♥ by West

<i>Trick</i>	<i>Lead</i>	<i>2nd</i>	<i>3rd</i>	<i>4th</i>
1. N	<u>♣A</u>	6	3	4
2. N	<u>♦J</u>	Q	<u>A</u>	4
3. S	<u>♣10</u>	Q	<u>K</u>	7
4. N	<u>♣5</u>	♦3	8	<u>J</u>
5. W	<u>♥K</u>	8	3	5
6. W	<u>♥J</u>	♠7	<u>A</u>	10
7. E	<u>♦7</u>	2	<u>K</u>	10
8. W	<u>♦9</u>	♠3	<u>♥7</u>	5
9. E	<u>♠K</u>	A	<u>♥2</u>	4
10. W	<u>♣9</u>	2	<u>♠2</u>	<u>♥Q</u>
11. S	<u>♠6</u>	-	-	-

Down 1 — NS +50

**Board 1097**  
 West Deals  
 Both Vul

<p>♠ J 10 9          ♥ A Q 4          ♦ 6 5 3 2          ♣ A 6 2</p>		<p>♠ Q 7          ♥ 5 3          ♦ A Q 10 9          ♣ K 10 8 5 4</p>	<p>♠ A 8 6 4 3 2          ♥ 6          ♦ J 8          ♣ Q J 7 3</p>
<p>♠ K 5          ♥ K J 10 9 8 7 2          ♦ K 7 4          ♣ 9</p>			

EW 3♠; NS 3♥; NS 1♦; Par -140

West	North	East	South
<i>bitran</i>	<i>BridgeGoth</i>	<i>abc36</i>	<i>jec</i>
Pass	Pass	2 ♠	3 ♥
3 ♠	Dbl	Pass	4 ♥
Dbl	Pass	Pass	Pass

4 ♥× by South

<i>Trick</i>	<i>Lead</i>	<i>2nd</i>	<i>3rd</i>	<i>4th</i>
1. W	♠ J	Q	<u>A</u>	5
2. E	♥ 6	J	<u>Q</u>	3
3. W	<u>♣ A</u>	4	7	9
4. W	♦ 6	<u>A</u>	8	7
5. N	♥ 5	♠ 2	K	<u>A</u>
6. W	♦ 5	-	-	-

Down 1 — NS -200

**Board 1107**  
 East Deals  
 None Vul

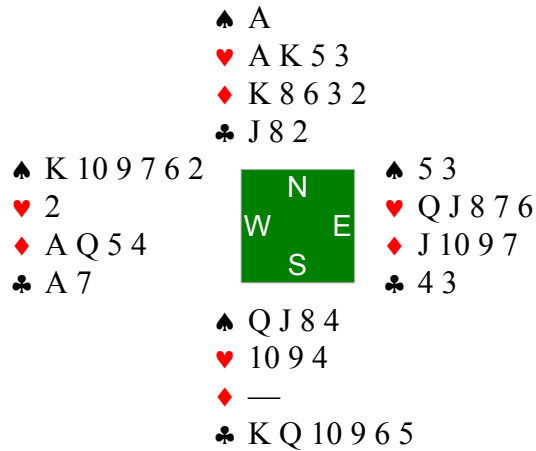

NS 3N; NS 5♣; EW 1♠; NS 1♥; EW 1♦; Par +400

West	North	East	South
<i>bitran</i>	<i>BridgeGoth</i>	<i>abc36</i>	<i>jec</i>
		Pass	Pass
1 ♠	Dbl	Pass	3 ♣
3 ♦	Dbl	Pass	4 ♣
Pass	5 ♣	Pass	Pass
Pass			

5 ♣ by South

Trick	Lead	2nd	3rd	4th
1. W	♥ 2	<u>K</u>	6	4
2. N	♠ A	3	4	2
3. N	♣ 2	3	9	<u>A</u>
4. W	♣ 7	8	4	<u>10</u>
5. S	♠ Q	K	♣ J	5
6. N	♦ 2	J	♣ 5	4
7. S	♥ 9	♠ 6	<u>A</u>	7
8. N	♦ 3	7	♣ 6	5
9. S	♣ K	♦ Q	♥ 3	♦ 9
10. S	♣ Q	♠ 7	♦ 6	♦ 10
11. S	♠ J	10	♦ 8	♥ 8

Down 1 — NS -50

**Board 1109**  
 West Deals  
 E-W Vul

♠ 10 7		♠ K 9 3
♥ K 5 3 2		♥ Q J
♦ Q J 10 5 4		♦ A 8 6 2
♣ Q J		♣ K 9 7 5
♠ A J 6 5		♥ 7 6 4
♥ A 10 9 8	♦ K 7 3	♣ A 10 8 6
♦ 9		
♣ A 10 8 6		

NS 2♠; EW 1N; EW 2♦; NS 1♥; EW 1♣; Par +110

West	North	East	South
<i>bitran</i>	<i>BridgeGoth</i>	<i>abc36</i>	<i>jec</i>
Pass	Pass	1♦	Pass
1♥	Dbl	Pass	1♠
1NT	Pass	Pass	2♠
3♦	Pass	Pass	Pass

3♦ by East

<i>Trick</i>	<i>Lead</i>	<i>2nd</i>	<i>3rd</i>	<i>4th</i>
1. S	♣ 2	J	<u>A</u>	5
2. N	♠ 4	K	<u>A</u>	7
3. S	♠ J	10	8	3
4. S	♠ 5	<u>♦ 4</u>	2	9
5. W	♦ Q	9	2	<u>K</u>
6. S	♣ 4	<u>Q</u>	6	7
7. W	<u>♦ J</u>	♠ Q	6	3
8. W	<u>♦ 10</u>	♥ 8	8	7
9. W	♥ 2	<u>A</u>	Q	4
10. N	♥ 10	-	-	-

Down 1 — NS +100



**Board 1117**  
 West Deals  
 None Vul

♠ A 3 ♥ 7 4 2 ♦ A K 6 4 3 ♣ Q 10 5		♠ K 10 9 6 5 4 ♥ Q 9 5 3 ♦ 10 ♣ A 4	♠ Q J 8 7 2 ♥ 10 8 ♦ Q J 9 ♣ 9 8 6
♠ — ♥ A K J 6 ♦ 8 7 5 2 ♣ K J 7 3 2			

NS 4♥; NS 2♠; S 3♣; N 2♣; Par +420

West	North	East	South
<i>bitran</i>	<i>BridgeGoth</i>	<i>abc36</i>	<i>jec</i>
1 ♦	Pass	1 ♠	Dbl
2 ♦	2 ♥	3 ♦	4 ♥
Pass	Pass	Pass	

4 ♥ by North

<i>Trick</i>	<i>Lead</i>	<i>2nd</i>	<i>3rd</i>	<i>4th</i>
1. E	♦ Q	2	6	10
2. E	♦ J	5	4	<u>♥ 3</u>
3. N	♣ A	6	2	5
4. N	♣ 4	9	J	<u>Q</u>
5. W	♣ 10	♠ 4	8	<u>K</u>
6. S	♦ 7	K	<u>♥ 9</u>	9
7. N	<u>♥ Q</u>	8	6	2
8. N	♥ 5	-	-	-

Made 4 — NS +420

**Board 1121**  
 West Deals  
 N-S Vul

♠ A 10 4 3	♠ K 9	♠ Q J 6 5 2
♥ J 8 7 4	♥ 9 6 2	♥ 5
♦ A 5 3	♦ 7 6	♦ Q 9 2
♣ K 10	♣ A J 7 4 3 2	♣ 9 8 6 5

♠ 8 7
♥ A K Q 10 3
♦ K J 10 8 4
♣ Q

NS 4♥; E 2♠; NS 3♦; NS 3♣; NS 1N; W 1♠; Par +300; E 4♠×-2

West	North	East	South
<i>bitran</i>	<i>BridgeGoth</i>	<i>abc36</i>	<i>jec</i>
1 ♦ <sup>1</sup>	Pass	1 ♠	2 ♥
2 ♠	3 ♥	Pass	Pass
3 ♠	Pass	Pass	Pass

1. best min

3 ♠ by East

<i>Trick</i>	<i>Lead</i>	<i>2nd</i>	<i>3rd</i>	<i>4th</i>
1. S	♥ A	4	2	5
2. S	♣ Q	K	A	5
3. N	♦ 7	9	J	3
4. S	♥ K	7	6	♠ 2
5. E	♣ 6	♠ 7	10	4
6. S	♠ 8	A	9	5
7. W	♥ 8	9	♠ 6	3
8. E	♣ 9	♦ 4	♠ 3	3
9. W	♥ J	♣ 2	♠ J	Q
10. E	♣ 8	♦ 8	♠ 4	7
11. W	♦ A	6	2	10
12. W	♦ 5	♣ J	Q	K
13. S	♥ 10	♠ 10	♠ K	♠ Q

Down 2 — NS +100

**Board 1127**  
 East Deals  
 E-W Vul

♠ A 8 7		♠ Q 6 5 4 2
♥ A Q J 3		♥ 10 8 6
♦ A J 4 2		♦ 9 8 7 6
♣ 9 2		♣ 4
♠ K J 10 3		♥ 9 2
		♦ 3
		♣ K Q J 10 6 3

NS 4♣; NS 2N; NS 1♠; NS 1♥; W 1♦; Par +130

West	North	East	South
<i>langya</i>	<i>BridgeGoth</i>	<i>antech</i>	<i>jec</i>
		Pass	Pass
1 NT	Pass	2♥ <sup>1</sup>	3♣
Pass	Pass	Pass	

1. =2S

3♣ by South

<i>Trick</i>	<i>Lead</i>	<i>2nd</i>	<i>3rd</i>	<i>4th</i>
1. W	♣ 2	5	4	<u>6</u>
2. S	♦ 3	<u>A</u>	5	7
3. W	♥ A	4	6	2
4. W	♥ Q	<u>K</u>	8	9
5. N	♣ 7	♠ 4	<u>K</u>	9
6. S	♣ 3	♠ 7	<u>A</u>	♠ 2
7. N	♦ K	6	♠ 3	2
8. N	♦ Q	8	♠ J	4
9. N	♠ 9	Q	K	<u>A</u>
10. W	♦ J	-	-	-

Made 4 — NS +130

**Board 1131**  
 East Deals  
 Both Vul

♠ J 5 ♥ 9 2 ♦ J 10 9 3 2 ♣ J 10 4 2		♠ 9 7 6 4 ♥ Q J 4 ♦ 7 6 4 ♣ Q 9 6	♠ K Q 10 8 2 ♥ 10 6 5 3 ♦ A K ♣ 7 3
♠ A 3 ♥ A K 8 7 ♦ Q 8 5 ♣ A K 8 5			

NS 2N; NS 2♥; NS 2♣; NS 1♠; NS 1♦; Par +120

West	North	East	South
<i>langya</i>	<i>BridgeGoth</i>	<i>antech</i>	<i>jec</i>
		1 ♠	Dbl
Pass	2 ♥	Pass	2 ♠
Pass	3 ♠	Pass	4 ♥
Pass	Pass	Pass	

4 ♥ by North

<i>Trick</i>	<i>Lead</i>	<i>2nd</i>	<i>3rd</i>	<i>4th</i>
1. E	♠ K	<u>A</u>	5	4
2. S	♣ 5	4	<u>Q</u>	3
3. N	♦ 4	<u>K</u>	5	2
4. E	♣ 7	<u>A</u>	2	6
5. S	♥ 7	2	<u>J</u>	3
6. N	♣ 9	<u>♥ 5</u>	8	J
7. E	♠ <u>Q</u>	3	J	6
8. E	♦ <u>A</u>	8	3	6
9. E	♠ 10	<u>♥ A</u>	♦ 9	7
10. S	<u>♥ K</u>	9	4	6
11. S	♥ 8	♣ 10	<u>Q</u>	10
12. N	♠ <u>9</u>	2	♣ K	♦ 10
13. N	♦ 7	♠ 8	<u>Q</u>	J

Down 1 — NS -100

**Board 1135**  
 East Deals  
 None Vul

♠ J 6 4	♠ A Q 8 5 2	♠ K
♥ 7	♥ 6 4 2	♥ A K Q 10 9 3
♦ K J 8 7 4	♦ 6 3 2	♦ Q 5
♣ 8 5 4 3	♣ Q 2	♣ J 10 9 6

♠ 10 9 7 3
♥ J 8 5
♦ A 10 9
♣ A K 7

NS 3♠; EW 2♥; NS 1N; EW 2♣; EW 1♦; Par +140

West	North	East	South
<i>langya</i>	<i>BridgeGoth</i>	<i>antech</i>	<i>jec</i>
		1 ♥	Pass
Pass	1 ♠	2 ♥	3 ♥
Pass	3 ♠	Pass	Pass

Pass

3 ♠ by North

<i>Trick</i>	<i>Lead</i>	<i>2nd</i>	<i>3rd</i>	<i>4th</i>
1. E	<u>♥ A</u>	5	7	2
2. E	<u>♥ K</u>	8	♦ 7	4
3. E	<u>♥ Q</u>	J	♦ 4	6
4. E	<u>♦ Q</u>	9	8	2
5. E	♦ 5	<u>A</u>	J	3
6. S	♠ 3	6	<u>A</u>	K
7. N	<u>♣ Q</u>	6	7	5
8. N	♣ 2	9	<u>A</u>	4
9. S	♠ 10	-	-	-

Made 3 — NS +140

**Board 1137**  
 West Deals  
 E-W Vul

♠ A 10 3	♠ K 4	♠ Q 9 8 7
♥ Q 2	♥ J 8 4	♥ A 10 7 5
♦ J 10 6 4 2	♦ Q 5	♦ A K 7 3
♣ Q 10 6	♣ A 8 7 5 3 2	♣ 9

♠ J 6 5 2
♥ K 9 6 3
♦ 9 8
♣ K J 4

W 5♦; EW 3♠; E 4♦; EW 2N; EW 2♥; NS 1♣; Par -600

West	North	East	South
<i>langya</i>	<i>BridgeGoth</i>	<i>antech</i>	<i>jec</i>
Pass	Pass	1♦	Pass
1 NT	2♣	Pass	3♣
3♦	Pass	Pass	Pass

3♦ by East

<i>Trick</i>	<i>Lead</i>	<i>2nd</i>	<i>3rd</i>	<i>4th</i>
1. S	♣ 4	6	<u>A</u>	9
2. N	♣ 5	<u>♦ 3</u>	J	10
3. E	♥ 5	<u>K</u>	2	4
4. S	♣ K	Q	2	<u>♦ 7</u>
5. E	<u>♦ A</u>	8	2	5
6. E	♥ 7	3	<u>Q</u>	8
7. W	♦ 4	Q	<u>K</u>	9
8. E	<u>♥ A</u>	6	♠ 3	J
9. E	♥ 10	9	-	-

Made 5 — NS -150

**Board 1139**

East Deals  
N-S Vul

♠ K 6 3 2 ♥ K Q 8 2 ♦ K ♣ K 9 8 5		♠ A J 9 8 7 ♥ A 6 4 ♦ Q 2 ♣ Q 10 3	♠ Q 5 4 ♥ J 10 5 3 ♦ A J 6 ♣ A 7 2
♠ 10 ♥ 9 7 ♦ 10 9 8 7 5 4 3 ♣ J 6 4			

EW 4N; EW 4♥; EW 3♠; EW 2♣; NS 1♦; Par -430

West	North	East	South
<i>langya</i>	<i>BridgeGoth</i>	<i>antech</i>	<i>jec</i>
		1 ♣	Pass
1 ♥	1 ♠	2 ♥	Pass
4 ♥	Pass	Pass	Pass

4 ♥ by West

<i>Trick</i>	<i>Lead</i>	<i>2nd</i>	<i>3rd</i>	<i>4th</i>
1. N	♣ 3	2	J	<u>K</u>
2. W	♥ <u>Q</u>	4	3	7
3. W	♥ 2	<u>A</u>	5	9
4. N	♥ 6	<u>10</u>	♦ 5	8
5. E	♣ <u>A</u>	6	8	10
6. E	♣ 7	4	5	<u>Q</u>
7. N	♦ 2	6	10	<u>K</u>
8. W	♣ <u>9</u>	♠ 8	♠ 4	♦ 3
9. W	♠ 3	<u>A</u>	5	10
10. N	♠ 7	Q	♦ 9	-

Made 4 — NS -420

**Board 1141**  
 West Deals  
 Both Vul

♠ A K Q 4 2	♠ J 8 6 3	♠ 9 5
♥ 10 8	♥ K Q 7 4 2	♥ 6 5 3
♦ K Q 8	♦ A 9 6 5	♦ J 10 7 4
♣ A 9 4	♣ —	♣ K 10 8 5

♠ 10 7
♥ A J 9
♦ 3 2
♣ Q J 7 6 3 2

W 2♠; NS 2♥; EW 1N; W 2♦; E 1♠; E 1♦; EW 1♣; Par -110

West	North	East	South
<i>langya</i>	<i>BridgeGoth</i>	<i>antech</i>	<i>jec</i>
1 ♠	Pass	Pass	2 ♣
Dbl	2 ♥	Pass	Pass

Pass

2 ♥ by North

<i>Trick</i>	<i>Lead</i>	<i>2nd</i>	<i>3rd</i>	<i>4th</i>
1. E	♠ 9	10	<u>Q</u>	3
2. W	♥ 10	2	3	<u>J</u>
3. S	♠ 7	<u>A</u>	6	5
4. W	♥ 8	4	5	<u>9</u>
5. S	♦ 2	K	<u>A</u>	7
6. N	♠ J	♣ 5	♦ 3	<u>K</u>
7. W	♣ 4	<u>♥ 7</u>	8	2
8. N	♦ 5	4	<u>♥ A</u>	8
9. S	♣ 3	9	<u>♥ Q</u>	10
10. N	♥ K	6	-	-

Made 2 — NS +110



**Board 1155**  
 East Deals  
 E-W Vul

♠ Q 10 7	♠ A 9 5 3 2	♠ J 8
♥ J 9 7 3	♥ K Q	♥ 5 4
♦ Q J 5	♦ 7 2	♦ K 10 8 4 3
♣ A K 8	♣ 10 7 5 2	♣ Q J 9 3
	<div style="display: inline-block; background-color: green; color: white; padding: 5px; text-align: center; margin: 5px;">             N              W     E              S           </div>	
	♠ K 6 4	
	♥ A 10 8 6 2	
	♦ A 9 6	
	♣ 6 4	

NS 3♠; NS 2♥; EW 2♦; EW 1♣; Par +140

West	North	East	South
<i>STRIK3R</i>	<i>smispi</i>	<i>stewball</i>	<i>jec</i>
		Pass	Pass
1 ♣	1 ♠	2 ♣	3 ♣
Pass	3 ♠	Pass	Pass
Pass			

3 ♠ by North

<i>Trick</i>	<i>Lead</i>	<i>2nd</i>	<i>3rd</i>	<i>4th</i>
1. E	♣ Q	4	<u>K</u>	5
2. W	♣ A	7	3	6
3. W	♦ Q	2	8	6
4. W	♦ J	7	K	<u>A</u>
5. S	♥ 2	7	<u>K</u>	4
6. N	♥ Q	5	6	3
7. N	♠ A	8	4	7
8. N	♠ 2	J	<u>K</u>	Q
9. S	♥ A	9	♣ 2	♦ 3

Made 3 — NS +140

**Board 1162**  
 North Deals  
 Both Vul

♠ 9 7 5 4 ♥ K J 10 ♦ J 3 ♣ 9 7 6 2	♠ 10 8 ♥ 9 8 7 6 4 3 ♦ 8 7 ♣ K 10 4		♠ K 6 3 ♥ 5 2 ♦ A Q 6 2 ♣ A J 5 3
♠ A Q J 2 ♥ A Q ♦ K 10 9 5 4 ♣ Q 8			

S 3♥; S 2♠; N 2♥; S 1N; E 1N; S 2♦; N 1♠; N 1♦; E 1♣; Par +140

West	North	East	South
<i>STRIK3R</i>	<i>smispi</i>	<i>stewball</i>	<i>jec</i>
	Pass	1♦	1NT
Pass	2♦	Pass	2♥
Pass	Pass	Pass	

2♥ by South

<i>Trick</i>	<i>Lead</i>	<i>2nd</i>	<i>3rd</i>	<i>4th</i>
1. W	♦ J	7	6	<u>K</u>
2. S	♦ 4	3	8	<u>Q</u>
3. E	♥ 2	Q	<u>K</u>	3
4. W	♥ J	4	5	<u>A</u>
5. S	♦ 10	♣ 2	♠ 8	<u>A</u>
6. E	♠ 3	<u>A</u>	4	10
7. S	♦ 9	<u>♥ 10</u>	♣ 4	2
8. W	♣ 6	-	-	-

Made 2 — NS +110

**Board 1165**  
 West Deals  
 E-W Vul

♠ A 10 6 5		♠ K 9 7
♥ K 3		♥ 7 2
♦ 6 4 3		♦ Q 10 9 2
♣ K Q 5 3		♣ J 8 7 4
		♠ Q 8
		♥ A Q 9 6 5
		♦ A K 8 7 5
		♣ 9

NS 4♥; NS 1N; NS 1♦; EW 1♣; Par +420

West	North	East	South
<i>STRIK3R</i>	<i>smispi</i>	<i>stewball</i>	<i>jec</i>
1 ♣	Pass	1 ♦	1 ♥
Pass	2 ♦	Pass	4 ♥
Pass	Pass	Pass	

4 ♥ by South

<i>Trick</i>	<i>Lead</i>	<i>2nd</i>	<i>3rd</i>	<i>4th</i>
1. W	♣ K	<u>A</u>	7	9
2. N	♦ J	Q	<u>K</u>	3
3. S	<u>♦ A</u>	6	♠ 2	2
4. S	♦ 5	4	<u>♥ 4</u>	9
5. N	♣ 2	4	<u>♥ 5</u>	3
6. S	♦ 7	♠ 5	<u>♥ 8</u>	10
7. N	♥ J	2	6	<u>K</u>
8. W	♥ 3	10	7	<u>A</u>
9. S	<u>♥ Q</u>	♣ 5	♣ 6	♣ 8
10. S	<u>♥ 9</u>	♠ 6	♣ 10	♠ 7
11. S	<u>♦ 8</u>	♠ 10	♠ 3	♣ J

Made 4 — NS +420

**Board 1181**  
 West Deals  
 N-S Vul

♠ K J 2 ♥ K 5 ♦ A 10 8 7 6 ♣ A 9 8		♠ A Q 9 8 ♥ A 10 9 6 3 2 ♦ J 5 ♣ K	♠ 10 7 3 ♥ J 8 7 4 ♦ 3 2 ♣ J 10 6 4
♠ 6 5 4 ♥ Q ♦ K Q 9 4 ♣ Q 7 5 3 2			

NS 2♠; NS 2♥; NS 1N; NS 1♦; NS 1♣; Par +110

West	North	East	South
<i>jauken</i>	<i>smispi</i>	<i>stewball</i>	<i>jec</i>
1 NT	2 ♣ <sup>1</sup>	Pass	2 ♠
Pass	Pass	Pass	

1. maj

2 ♠ by South

<i>Trick</i>	<i>Lead</i>	<i>2nd</i>	<i>3rd</i>	<i>4th</i>
1. W	♣ 8	<u>K</u>	6	2
2. N	<u>♦ J</u>	3	4	6
3. N	♦ 5	2	Q	<u>A</u>
4. W	♦ 7	♥ 2	<u>♠ 3</u>	9
5. E	♣ J	3	9	<u>♠ 8</u>
6. N	<u>♥ A</u>	4	Q	5
7. N	♥ 3	7	<u>♠ 4</u>	K
8. S	♠ 5	2	Q	7
9. N	♥ 9	8	♦ K	<u>♠ K</u>
10. W	♠ J	<u>A</u>	10	6
11. N	♥ 6	<u>J</u>	♣ 5	♦ 8
12. E	♣ 4	7	A	<u>♠ 9</u>
13. N	<u>♥ 10</u>	♣ 10	♣ Q	♦ 10

Made 3 — NS +140

**Board 1184**  
 South Deals  
 E-W Vul

♠ K Q 9 7 6	♠ 4	♠ A J 10
♥ A J 5 3	♥ 2	♥ K 9 8 6 4
♦ 3	♦ J 10 5	♦ 8 6 4
♣ J 10 4	♣ A K Q 9 8 7 5 2	♣ 6 3

N
W    E
S

♠ 8 5 3 2
♥ Q 10 7
♦ A K Q 9 7 2
♣ —

EW 4♠; NS 5♦; NS 5♣; EW 3♥; Par +200; EW 5♠×-1

West	North	East	South
<i>ghionis</i>	<i>llorenzo</i>	<i>alati</i>	<i>jec</i>
			Pass
1 ♠	5 ♣	Dbl	Pass
5 ♥	Pass	Pass	Pass

5 ♥ by West

<i>Trick</i>	<i>Lead</i>	<i>2nd</i>	<i>3rd</i>	<i>4th</i>
1. N	<u>♣ A</u>	3	♦ 9	10
2. N	<u>♣ K</u>	6	♦ 2	4
3. N	♣ 2	<u>♥ K</u>	♠ 3	J
4. E	♥ 4	7	<u>J</u>	2
5. W	♠ 6	4	<u>10</u>	2
6. E	♥ 9	10	<u>A</u>	♣ 5
7. W	♠ 7	♣ 7	<u>A</u>	8
8. E	♠ J	5	<u>K</u>	♣ 8
9. W	♠ Q	♣ 9	♦ 4	<u>♥ Q</u>
10. S	<u>♦ A</u>	3	5	6
11. S	♦ K	-	-	-

Down 2 — NS +200

**Board 1187**  
 East Deals  
 E-W Vul

♠ 5 3 2 ♥ A K J 9 2 ♦ 6 4 3 ♣ 10 4		♠ K 9 8 6 ♥ 10 8 ♦ 10 9 8 5 ♣ J 7 2	♠ Q J 10 4 ♥ 3 ♦ K Q J 2 ♣ A 6 5 3
♠ A 7 ♥ Q 7 6 5 4 ♦ A 7 ♣ K Q 9 8			

EW 1N; EW 1♠; EW 1♥; EW 1♦; NS 1♣; Par -90

West	North	East	South
<i>ghionis</i>	<i>llorenzo</i>	<i>alati</i>	<i>jec</i>
		1♦	1♥
1NT	Pass	Pass	2♣
Pass	2♥	Pass	Pass
Dbl	Pass	Pass	Pass

2♥× by South

<i>Trick</i>	<i>Lead</i>	<i>2nd</i>	<i>3rd</i>	<i>4th</i>
1. W	♦ 4	5	<u>J</u>	7
2. E	♦ Q	<u>A</u>	6	8
3. S	♣ 8	4	J	<u>A</u>
4. E	♠ Q	<u>A</u>	5	6
5. S	♠ 7	3	<u>K</u>	4
6. N	♠ 8	10	<u>♥ 4</u>	2
7. S	<u>♣ K</u>	10	2	3
8. S	<u>♣ Q</u>	<u>♥ 2</u>	7	5
9. W	♦ 3	9	K	<u>♥ 5</u>
10. S	♣ 9	<u>♥ J</u>	♠ 9	6
11. W	<u>♥ A</u>	8	3	6
12. W	<u>♥ K</u>	10	♦ 2	7
13. W	♥ 9	♦ 10	♠ J	<u>Q</u>

Down 1 — NS -100

**Board 1188**  
 South Deals  
 Both Vul

<p>♠ 9 7 2          ♥ A K 10          ♦ Q 6          ♣ J 10 9 6 2</p>		<p>♠ A 10 6 4          ♥ J          ♦ A 10 9 8 7          ♣ 8 5 3</p>	<p>♠ K Q J 8 5 3          ♥ Q 3 2          ♦ 4          ♣ Q 7 4</p>
<p>♠ —          ♥ 9 8 7 6 5 4          ♦ K J 5 3 2          ♣ A K</p>			

NS 6♦; NS 3♥; NS 2N; EW 1♠; EW 1♣; Par +1370

West	North	East	South
<i>ghionis</i>	<i>llorenzo</i>	<i>alati</i>	<i>jec</i>
			Pass
Pass	Pass	1 ♠	2 ♠
3 ♠	4 ♠	Pass	5 ♥
Dbl	6 ♦	Pass	Pass
Dbl	Pass	Pass	Pass

6♦× by North

<i>Trick</i>	<i>Lead</i>	<i>2nd</i>	<i>3rd</i>	<i>4th</i>
1. E	♠ K	♥ 4	9	<u>A</u>
2. N	♦ A	4	2	6
3. N	♦ 7	♠ 8	<u>K</u>	Q
4. S	♥ 5	<u>K</u>	J	3
5. W	♣ 2	3	4	<u>K</u>
6. S	♥ 6	A	♦ 8	2
7. N	♣ 5	7	<u>A</u>	6
8. S	♥ 7	10	♦ 9	-

Made 6 — NS +1540

**Board 1192**  
 South Deals  
 None Vul

♠ K 7 6 4 2		♠ 9 8
♥ A K Q 8 5 4 3		♥ 10 9 2
♦ —		♦ A K 9 8 6
♣ 8		♣ A 7 3
♠ Q J 10	<div style="display: inline-block; background-color: green; color: white; padding: 5px; border: 1px solid black;">           N            W     E            S         </div>	♠ A 5 3
♥ J 7 6		♥ —
♦ Q 10 7		♦ J 5 4 3 2
♣ K Q J 10		♣ 9 6 5 4 2

NS 5♠; NS 5♥; EW 1♦; Par +450

West <i>ghionis</i>	North <i>llorenzo</i>	East <i>alati</i>	South <i>jec</i>
		Dbl	
1 ♣	4 ♥		Pass
Pass	Pass		Pass

4♥× by North

<i>Trick</i>	<i>Lead</i>	<i>2nd</i>	<i>3rd</i>	<i>4th</i>
1. E	♦ A	2	7	♥ 3
2. N	♥ A	2	♣ 2	6
3. N	♥ K	9	♣ 4	7
4. N	♥ Q	10	♦ 3	J
5. N	♠ 2	8	♠ A	10
6. S	♠ 3	J	♠ K	9
7. N	♠ 7	♦ 6	5	Q
8. W	♣ K	-	-	-

Made 5 — NS +690



**Board 1193**  
 West Deals  
 N-S Vul

♠ 10 9 3 ♥ A Q 10 9 3 ♦ A ♣ Q J 10 5		♠ Q 7 6 4 ♥ J 5 ♦ 9 5 3 2 ♣ A 8 4	♠ J 8 5 2 ♥ 8 7 6 ♦ 10 8 6 4 ♣ 6 2
♠ A K ♥ K 4 2 ♦ K Q J 7 ♣ K 9 7 3			

S 3♠; NS 2N; N 2♠; NS 3♦; S 3♣; N 2♣; Par +140

West	North	East	South
<i>ghionis</i>	<i>llorenzo</i>	<i>alati</i>	<i>jec</i>
1 ♥	Pass	Pass	Dbl
2 ♣	Pass	2 ♥	2 NT
Pass	3 ♥	Pass	3 ♠
Pass	4 ♠	Pass	Pass
Pass			

4 ♠ by South

Trick	Lead	2nd	3rd	4th
1. W	♣ Q	<u>A</u>	2	3
2. N	♠ 4	2	<u>K</u>	3
3. S	<u>♠ A</u>	9	6	5
4. S	♦ K	<u>A</u>	2	4
5. W	♣ 10	4	6	<u>K</u>
6. S	♦ Q	<u>♠ 10</u>	3	6
7. W	♣ J	8	♥ 8	7
8. W	♣ 5	♥ 5	<u>♠ 8</u>	9
9. E	♥ 7	2	<u>Q</u>	J
10. W	♥ A	<u>♠ 7</u>	6	4
11. N	<u>♠ Q</u>	J	♦ 7	♥ 3
12. N	♦ 5	8	<u>J</u>	♥ 9
13. S	♥ K	10	♦ 9	♦ 10

Down 2 — NS -200

**Board 1195**  
 East Deals  
 None Vul

♠ Q J 5 ♥ A K J 9 2 ♦ 5 ♣ 7 6 5 3		♠ 10 4 ♥ Q 8 7 5 3 ♦ J 10 8 7 6 ♣ 2	♠ K 8 7 6 3 2 ♥ 10 ♦ A K 4 2 ♣ A 4
♠ A 9 ♥ 6 4 ♦ Q 9 3 ♣ K Q J 10 9 8			

EW 6♠; EW 3♥; EW 1N; EW 1♣; Par -980

West	North	East	South
<i>ghionis</i>	<i>llorenzo</i>	<i>alati</i>	<i>jec</i>
		1 ♠	2 ♣
2 ♥	Pass	2 ♠	Pass
3 ♠	Pass	4 ♠	Pass
Pass	Pass		

4 ♠ by East

Trick	Lead	2nd	3rd	4th
1. S	♣ K	3	2	<u>A</u>
2. E	♥ 10	4	<u>K</u>	3
3. W	♥ A	5	♣ 4	6
4. W	♦ 5	6	<u>A</u>	3
5. E	♦ K	9	♥ 2	7
6. E	♦ 2	Q	♠ 5	8
7. W	♣ 5	♦ 10	♠ 2	8
8. E	♦ 4	♣ 9	♠ J	J
9. W	♠ Q	4	3	<u>A</u>
10. S	♣ Q	6	♠ 10	<u>♠ K</u>
11. E	♠ 6	<u>9</u>	♣ 7	♥ 7
12. S	♣ J	-	-	-

Made 5 — NS -450

**Board 1196**  
 South Deals  
 N-S Vul

♠ Q 9 ♥ A J 10 9 7 4 ♦ — ♣ A 10 7 6 3		<div style="background-color: green; color: white; padding: 5px; display: inline-block;">           N            W     E                 S         </div>	♠ A 10 6 ♥ Q 8 3 ♦ K Q 9 7 4 ♣ 8 4  ♠ 8 7 5 2 ♥ — ♦ A 8 6 5 3 ♣ K J 5 2  ♠ K J 4 3 ♥ K 6 5 2 ♦ J 10 2 ♣ Q 9
--	--	---	--

EW 5♣; EW 3♥; EW 1N; NS 1♦; Par -400

West	North	East	South
<i>ghionis</i>	<i>llorenzo</i>	<i>alati</i>	<i>jec</i>
			Pass
1 ♥	Pass	1 ♠	Pass
2 ♣	Pass	3 ♣	Pass
3 ♦	Dbl	Rdbl	Pass
4 ♦	Pass	5 ♣	Pass
Pass	Pass		

5 ♣ by West

<i>Trick</i>	<i>Lead</i>	<i>2nd</i>	<i>3rd</i>	<i>4th</i>
1. N	♣ 4	2	Q	<u>A</u>
2. W	<u>♥ A</u>	3	♠ 2	2
3. W	♥ 4	8	<u>♣ 5</u>	5
4. E	<u>♦ A</u>	2	♠ 9	4
5. E	♦ 3	10	<u>♣ 3</u>	7
6. W	♥ 7	Q	<u>♣ J</u>	6
7. E	♦ 5	J	<u>♣ 6</u>	9
8. W	♥ 9	♠ 6	<u>♣ K</u>	K
9. E	♦ 6	<u>♣ 9</u>	♠ Q	Q
10. S	♠ 3	<u>♣ 7</u>	10	5
11. W	<u>♣ 10</u>	8	♠ 7	♠ 4

Made 6 — NS -420

**Board 1198**  
 North Deals  
 None Vul

♠ A 10 9 5 4		♠ J 6 2
♥ A 10 7 2		♥ Q 8
♦ 10 9 6		♦ A Q 7 4
♣ 10		♣ K 9 3 2
♠ K Q 8 7	<div style="display: inline-block; background-color: green; color: white; padding: 5px; border: 1px solid black;">           N            W     E            S         </div>	♠ 3
♥ J 3		♥ K 9 6 5 4
♦ J 2		♦ K 8 5 3
♣ A Q 8 6 5		♣ J 7 4

NS 4♥; EW 1♠; NS 1♦; EW 1♣; Par +420

West	North	East	South
<i>ghionis</i>	<i>llorenzo</i>	<i>alati</i>	<i>jec</i>
	Pass	Pass	Pass
1♣	1♠	2♠	Pass
2NT	Pass	Pass	Pass

2NT by West

<i>Trick</i>	<i>Lead</i>	<i>2nd</i>	<i>3rd</i>	<i>4th</i>
1. N	♥ 2	8	<u>K</u>	3
2. S	♥ 5	J	<u>A</u>	Q
3. N	<u>♥ 10</u>	♦ 4	4	♠ 7
4. N	♥ 7	♠ 2	<u>9</u>	♦ 2
5. S	<u>♥ 6</u>	♠ 8	♠ 9	♠ 6
6. S	♠ 3	Q	<u>A</u>	J
7. N	♠ 4	♦ 7	♦ 8	<u>K</u>
8. W	♣ 5	10	<u>K</u>	4

Down 1 — NS +50

**Board 1199**

East Deals  
N-S Vul

♠ J 9 6 3	♠ A K 5 2	♠ 7
♥ 7 4	♥ Q J 2	♥ A K 3
♦ 9 6	♦ A 10 7 4	♦ K Q J 3 2
♣ K J 9 6 5	♣ A 7	♣ 10 8 4 2

♠ Q 10 8 4
♥ 10 9 8 6 5
♦ 8 5
♣ Q 3

EW 4♣; NS 2♠; NS 2♥; EW 2♦; Par -130

West	North	East	South
<i>ghionis</i>	<i>llorenzo</i>	<i>alati</i>	<i>jec</i>
		1 ♦	Pass
1 ♠	1 NT <sup>1</sup>	2 ♣	2 ♥
3 ♣	3 ♥	Pass	Pass
4 ♣	Pass	Pass	Pass

1. nat

4 ♣ by East

<i>Trick</i>	<i>Lead</i>	<i>2nd</i>	<i>3rd</i>	<i>4th</i>
1. S	♥ 10	4	2	<u>K</u>
2. E	♠ 7	4	3	<u>K</u>
3. N	♦ 4	<u>K</u>	5	6
4. E	♥ <u>A</u>	6	7	J
5. E	♥ 3	5	<u>♣ 9</u>	Q
6. W	♦ 9	<u>A</u>	2	8
7. N	♠ A	<u>♣ 2</u>	8	6
8. E	♦ J	♥ 8	♠ 9	7
9. E	♦ <u>Q</u>	♠ 10	♠ J	10
10. E	♣ 8	3	5	<u>A</u>
11. N	♠ 2	<u>♣ 10</u>	Q	♣ 6
12. E	♣ 4	Q	-	-

Made 4 — NS -130

**Board 1211**  
 East Deals  
 N-S Vul

♠ A 9 8 5	<div style="display: inline-block; background-color: green; color: white; padding: 10px; border: 1px solid black;">           N W     E S         </div>	♠ K Q 7
♥ 2		♥ A K Q 10 9 6 4
♦ Q J 6 5 3		♦ 9
♣ 8 7 2		♣ Q 9
	♠ 10 6 4	
	♥ J 8 3	
	♦ 10 4	
	♣ 10 6 5 4 3	

EW 4♥; EW 2N; EW 2♠; W 1♦; NS 1♣; Par -420

West	North	East	South
<i>wy7199</i>	<i>miamiwiz</i>	<i>precisebri</i>	<i>jec</i>
		1 ♥	Pass
1 ♠	Dbl	Rdbl <sup>1</sup>	2 ♣
Pass	Pass	4 ♥	Pass
Pass	Pass		

1. 3S

4 ♥ by East

<i>Trick</i>	<i>Lead</i>	<i>2nd</i>	<i>3rd</i>	<i>4th</i>
1. S	♦ 10	Q	<u>K</u>	9
2. N	<u>♣ K</u>	9	3	2
3. N	<u>♣ A</u>	Q	4	7
4. N	♦ A	<u>♥ 4</u>	4	3
5. E	<u>♥ A</u>	3	2	5
6. E	<u>♥ K</u>	8	♠ 5	7

Made 4 — NS -420

**Board 1213**  
West Deals  
Both Vul

	♠ A K 9 8 5		
	♥ 6 3		
	♦ K 9 3		
	♣ Q 9 5		
♠ 10 4 ♥ A J 5 ♦ A J 8 7 6 4 ♣ 8 7	<div style="display: inline-block; background-color: green; color: white; padding: 5px; text-align: center;">             N W     E S           </div>	♠ Q 6 2 ♥ Q 9 8 7 ♦ Q 10 5 ♣ A 10 6	
	♠ J 7 3		
	♥ K 10 4 2		
	♦ 2		
	♣ K J 4 3 2		

NS 2♠; EW 3♦; NS 2♣; EW 1♥; Par -110

West	North	East	South
<i>wy7199</i>	<i>miamiwiz</i>	<i>precisebri</i>	<i>jec</i>
1 ♦	1 ♠	Dbl	2 ♠
2 NT <sup>1</sup>	Pass	3 ♣ <sup>2</sup>	Pass
3 ♦ <sup>3</sup>	Pass	Pass	Pass

1. relay 3c
2. relayed
3. weak'

3 ♦ by West

<i>Trick</i>	<i>Lead</i>	<i>2nd</i>	<i>3rd</i>	<i>4th</i>
1. N	♠ <u>A</u>	2	3	4
2. N	♣ 5	6	<u>K</u>	8
3. S	♣ 3	7	Q	<u>A</u>
4. E	♦ <u>Q</u>	2	6	3
5. E	♣ 10	J	♦ <u>8</u>	9
6. W	♠ 10	<u>K</u>	6	7
7. N	♠ 9	<u>Q</u>	J	♥ 5
8. E	♦ 5	♣ 4	J	<u>K</u>
9. N	♦ 9	<u>10</u>	♥ 2	7
10. E	♥ 7	4	<u>J</u>	6

Made 3 — NS -110

**Board 1214**  
 North Deals  
 N-S Vul

♠ K Q 9 5	♠ A 3 2	♠ J 10 8 7 6 4
♥ Q 8 6 4	♥ 7	♥ A 5
♦ J 10 6 4	♦ K 8	♦ Q 9 5
♣ 8	♣ Q J 9 7 5 4 2	♣ K 10
	<div style="display: inline-block; background-color: green; color: white; padding: 5px; text-align: center;">             N              W     E              S           </div>	
	♠ —	
	♥ K J 10 9 3 2	
	♦ A 7 3 2	
	♣ A 6 3	

NS 6♣; NS 4N; NS 4♥; EW 1♠; NS 1♦; Par +1100: EW 6♠×-5

West	North	East	South
<i>wy7199</i>	<i>miamiwiz</i>	<i>precisebri</i>	<i>jec</i>
	Pass	1 ♠	2 ♥
2 ♠	3 ♣	3 ♠	4 ♣
4 ♠	5 ♣	Pass	Pass

Pass

5 ♣ by North

Trick	Lead	2nd	3rd	4th
1. E	♦ 5	2	10	<u>K</u>
2. N	♥ 7	5	<u>K</u>	4
3. S	♥ 2	6	<u>♣ 2</u>	A
4. N	♣ J	K	<u>A</u>	8
5. S	♣ 3	♠ 5	<u>Q</u>	10
6. N	♦ 8	9	<u>A</u>	4
7. S	♥ J	Q	-	-

Made 7 — NS +640



**Board 1216**  
 South Deals  
 Both Vul

♠ 9 8 5 3 ♥ Q 4 2 ♦ K Q 2 ♣ A K J	♠ A K 6 4 ♥ A K 8 ♦ A 9 ♣ 9 7 3 2		♠ 10 2 ♥ 10 7 6 5 3 ♦ J 8 6 3 ♣ 5 4
♠ Q J 7 ♥ J 9 ♦ 10 7 5 4 ♣ Q 10 8 6			

NS 2N; NS 2♠; NS 3♣; EW 1♥; NS 1♦; Par +120

West	North	East	South
<i>wy7199</i>	<i>miamiwiz</i>	<i>precisebri</i>	<i>jec</i>
			Pass
1 NT	Dbl <sup>1</sup>	2♦ <sup>2</sup>	Pass
2♥	Pass	Pass	Pass

- 1. good hand
- 2. D+higher

2♥ by West

<i>Trick</i>	<i>Lead</i>	<i>2nd</i>	<i>3rd</i>	<i>4th</i>
1. N	<u>♠ A</u>	2	Q	5
2. N	<u>♦ A</u>	3	5	2
3. N	♦ 9	6	4	<u>K</u>
4. W	♥ 2	<u>K</u>	3	9
5. N	♠ 6	10	<u>J</u>	3
6. S	♦ 7	Q	<u>♥ 8</u>	8
7. N	♠ K	<u>♥ 5</u>	7	8
8. E	♥ 6	J	Q	<u>A</u>

Down 1 — NS +100

**Board 1219**  
 East Deals  
 Both Vul

♠ K Q 3	♠ 9 8 7 5 4	♠ A J 6
♥ A 10 5 4	♥ Q 2	♥ 6
♦ Q 9 3	♦ 10 8 6 5	♦ K J 7 4 2
♣ 8 6 3	♣ Q 9	♣ K 10 7 4

♠ 10 2
♥ K J 9 8 7 3
♦ A
♣ A J 5 2

E 2♠; NS 2♥; EW 3♦; W 1N; W 1♠; EW 1♣; Par -110

West	North	East	South
<i>wy7199</i>	<i>miamiwiz</i>	<i>precisebri</i>	<i>jec</i>
		1 ♦	1 ♥
2 NT	Pass	3 NT	Pass
Pass	Pass		

3 NT by West

<i>Trick</i>	<i>Lead</i>	<i>2nd</i>	<i>3rd</i>	<i>4th</i>
1. N	<u>♥ Q</u>	6	9	4
2. N	♥ 2	♣ 4	J	<u>A</u>
3. W	♠ K	4	<u>A</u>	2
4. E	♦ 2	<u>A</u>	9	5
5. S	<u>♥ K</u>	5	♠ 5	♣ 7
6. S	♥ 3	10	♠ 7	-

Made 3 — NS -600

**Board 1221**  
 West Deals  
 N-S Vul

♠ J 8 7 4 3 ♥ — ♦ Q 7 6 5 ♣ K Q J 5		♠ 10 6 ♥ A Q 8 3 2 ♦ J 8 4 ♣ 8 7 4	♠ Q 5 ♥ K 7 6 4 ♦ K 9 2 ♣ A 10 3 2
♠ A K 9 2 ♥ J 10 9 5 ♦ A 10 3 ♣ 9 6			

EW 2♠; NS 2♥; EW 3♣; NS 1N; EW 2♦; Par -110

West	North	East	South
<i>wy7199</i>	<i>miamiwiz</i>	<i>precisebri</i>	<i>jec</i>
Pass	Pass	1 ♣	Dbl
1 ♠	2 ♥	Pass	Pass
3 ♣	3 ♥	Pass	Pass

Pass

3 ♥ by North

<i>Trick</i>	<i>Lead</i>	<i>2nd</i>	<i>3rd</i>	<i>4th</i>
1. E	♥ 4	J	♠ 8	2
2. S	♣ 9	J	4	2
3. W	♣ 5	8	<u>10</u>	6
4. E	♥ 6	5	♦ 7	<u>8</u>
5. N	♣ 7	A	♥ <u>10</u>	Q
6. S	♥ 9	♦ 5	<u>A</u>	7
7. N	♦ J	K	<u>A</u>	6
8. S	♠ <u>A</u>	4	6	5
9. S	♠ <u>K</u>	3	10	Q
10. S	♠ 2	7	♥ 3	♥ <u>K</u>
11. E	♣ 3	♠ 9	K	♥ <u>Q</u>
12. N	♦ 4	2	10	<u>Q</u>
13. W	♠ <u>J</u>	♦ 8	♦ 9	♦ 3

Down 1 — NS -100

**Board 1222**  
 North Deals  
 Both Vul

♠ A 9 5	<div style="display: inline-block; background-color: green; color: white; padding: 10px; border: 1px solid black;">           N W     E S         </div>	♠ 10 3 2
♥ Q 8 7 5		♥ K J 10 3 2
♦ 5		♦ K 9 8
♣ 10 8 7 5 4		♣ A J

♠ K Q 8 7 6 4  
 ♥ A  
 ♦ A 10 7 3  
 ♣ 6 3

NS 4♠; NS 5♦; EW 2♥; NS 1N; Par +620

West	North	East	South
<i>wy7199</i>	<i>miamiwiz</i>	<i>precisebri</i>	<i>jec</i>
	Pass	1 ♥	1 ♠
2 ♥	Dbl	Pass	3 ♥
Dbl	4 ♦	Pass	5 ♦
Pass	Pass	Pass	

5 ♦ by North

<i>Trick</i>	<i>Lead</i>	<i>2nd</i>	<i>3rd</i>	<i>4th</i>
1. E	♥ J	<u>A</u>	8	6
2. S	♠ 4	<u>A</u>	J	10
3. W	♣ 8	K	<u>A</u>	3
4. E	♣ J	6	5	<u>Q</u>
5. N	♦ 2	8	<u>10</u>	5
6. S	♠ 6	9	<u>♦ 6</u>	3
7. N	♦ Q	K	<u>A</u>	♥ 5

Made 5 — NS +600

**Board 1223**

East Deals  
None Vul

♠ K 10 6 ♥ Q 10 8 2 ♦ A 4 3 2 ♣ K 6		♠ A 8 7 ♥ J 6 5 3 ♦ J ♣ A 10 9 5 4	♠ Q 9 5 2 ♥ A 4 ♦ K 10 9 6 5 ♣ J 3
		♠ J 4 3 ♥ K 9 7 ♦ Q 8 7 ♣ Q 8 7 2	

EW 4♠; EW 4♦; EW 2N; EW 2♥; NS 1♣; Par -420

West	North	East	South
wy7199	miamiwiz	precisebri	jec
		Pass	Pass
1 ♦	Pass	1 ♠	Pass
Pass	Dbl	3 ♦	Pass
Pass	Pass		

3 ♦ by West

Trick	Lead	2nd	3rd	4th
1. N	♥ 5	4	<u>K</u>	8
2. S	♥ 9	2	3	<u>A</u>
3. E	♦ <u>K</u>	7	3	J
4. E	♦ <u>10</u>	8	4	♣ 5
5. E	♦ 5	Q	<u>A</u>	♣ 4
6. W	♥ <u>Q</u>	6	♣ 3	7
7. W	♥ 10	J	♦ <u>6</u>	♣ 7
8. E	♠ 2	3	10	<u>A</u>
9. N	♣ A	J	2	-

Made 4 — NS -130

**Board 1226**  
 North Deals  
 None Vul

	♠ 9 8											
	♥ J 10 8 5											
	♦ 9 8 7 6 5 2											
	♣ J											
♠ A 10 3 2 ♥ 7 4 3 ♦ A J ♣ K 10 7 6	<div style="background-color: green; color: white; padding: 10px; display: inline-block;"> <table style="border: none; text-align: center; width: 60px; height: 60px;"> <tr><td></td><td>N</td><td></td></tr> <tr><td>W</td><td></td><td>E</td></tr> <tr><td></td><td>S</td><td></td></tr> </table> </div>		N		W		E		S		♠ K J 6 5 4 ♥ A 9 6 ♦ 10 3 ♣ A 4 3	
	N											
W		E										
	S											
	♠ Q 7											
	♥ K Q 2											
	♦ K Q 4											
	♣ Q 9 8 5 2											

EW 4N; EW 4♠; NS 2♦; EW 2♣; EW 1♥; Par -430

West	North	East	South
<i>wy7199</i>	<i>miamiwiz</i>	<i>precisebri</i>	<i>jec</i>
	Pass	1 ♠	Dbl
2 NT <sup>1</sup>	Pass	3 ♠	Pass
4 ♠	Pass	Pass	Pass

1. fit inv

4 ♠ by East

<i>Trick</i>	<i>Lead</i>	<i>2nd</i>	<i>3rd</i>	<i>4th</i>
1. S	♣ 2	6	J	<u>A</u>
2. E	♠ 4	7	<u>A</u>	8
3. W	♠ 2	9	J	<u>Q</u>
4. S	♥ K	3	8	<u>A</u>
5. E	♣ 4	8	<u>10</u>	♦ 2
6. W	♥ 4	5	9	<u>Q</u>
7. S	♥ 2	7	<u>10</u>	6
8. N	♦ 9	10	K	<u>A</u>
9. W	♠ 10	♦ 5	<u>K</u>	♣ 5
10. E	<u>♠ 6</u>	♦ 4	3	♥ J
11. E	<u>♠ 5</u>	♦ Q	♣ 7	♦ 6
12. E	♦ 3	♣ Q	J	7
13. W	<u>♣ K</u>	♦ 8	3	9

Made 4 — NS -420

**Board 1229**  
 West Deals  
 Both Vul

♠ 8 7 3 ♥ 3 ♦ K Q J 9 6 5 ♣ 9 5 4		♠ J 10 ♥ 9 6 2 ♦ A 8 3 ♣ A K 10 8 3	♠ Q 5 4 ♥ K Q J 8 7 5 ♦ 7 ♣ Q 7 6
♠ A K 9 6 2 ♥ A 10 4 ♦ 10 4 2 ♣ J 2			

NS 5♠; NS 4N; NS 3♥; NS 4♣; NS 2♦; Par +650

West	North	East	South
<i>wy7199</i>	<i>miamiwiz</i>	<i>precisebri</i>	<i>jec</i>
2♦ <sup>1</sup>	Pass	Pass	2♠
Pass	2NT	Pass	Pass
Pass			

1. w2

2 NT by North

<i>Trick</i>	<i>Lead</i>	<i>2nd</i>	<i>3rd</i>	<i>4th</i>
1. E	♥K	4	3	2
2. E	♥Q	<u>A</u>	♠3	6
3. S	♣J	9	<u>A</u>	6
4. N	♠J	Q	<u>A</u>	8
5. S	♠K	7	10	4
6. S	♠9	♦5	♦3	5
7. S	♠6	♦6	♦8	♥5
8. S	♠2	♣5	♣3	♥7
9. S	♦2	9	<u>A</u>	7
10. N	♥9	<u>J</u>	10	♦J
11. E	♥8	♦4	♦Q	♣10
12. E	♣7	2	4	<u>8</u>
13. N	♣K	Q	♦10	♦K

Made 4 — NS +180

**Board 1233**  
 West Deals  
 None Vul

♠ A 8		♠ 10 3
♥ A K Q 7 2		♥ J 9 5 4 3
♦ 9 3		♦ J 10 6 2
♣ K 10 6 4		♣ 5 2
♠ K Q 9 7 6 5 4	<div style="display: inline-block; background-color: green; color: white; padding: 5px; border: 1px solid black;">           N            W      E            S         </div>	♠ J 2
♥ 10 8		♥ 6
♦ Q 7		♦ A K 8 5 4
♣ 9 8		♣ A Q J 7 3

NS 7♣; NS 6N; NS 4♥; NS 5♦; NS 1♠; Par +1440

West	North	East	South
wy7199	miamiwiz	precisebri	jec
3 ♠	4 ♥	Pass	Pass
Pass			

4 ♥ by North

Trick	Lead	2nd	3rd	4th
1. E	♠ 10	2	<u>Q</u>	8
2. W	♠ K	<u>A</u>	3	J
3. N	<u>♥ A</u>	3	6	8
4. N	<u>♥ K</u>	4	♦ 4	10
5. N	<u>♥ Q</u>	5	♦ 5	♠ 6
6. N	<u>♣ 10</u>	2	3	8
7. N	♣ 4	5	<u>A</u>	9
8. S	♣ Q	♠ 5	<u>K</u>	♦ 2
9. N	♣ 6	<u>♥ 9</u>	7	♠ 7
10. E	♥ J	-	-	-

Made 4 — NS +420



**Board 1243**  
 East Deals  
 E-W Vul

	♠ Q 2		
	♥ K J 5 3		
	♦ K Q J 5		
	♣ A K 7		
♠ 6 4 3 ♥ Q 10 8 ♦ A 10 8 7 6 4 ♣ 2	<div style="display: inline-block; background-color: green; color: white; padding: 5px; text-align: center;">       N W     E S     </div>	♠ A K 10 8 7 5 ♥ 9 6 ♦ 9 2 ♣ Q 5 3	
	♠ J 9		
	♥ A 7 4 2		
	♦ 3		
	♣ J 10 9 8 6 4		

NS 3♥; EW 2♠; NS 3♣; EW 1♦; Par +140

West	North	East	South
<i>vikordani</i>	<i>smispi</i>	<i>beccamin</i>	<i>jec</i>
		2 ♠	Pass
3 ♠	Dbl	Pass	4 ♥
Pass	Pass	Pass	

4 ♥ by South

<i>Trick</i>	<i>Lead</i>	<i>2nd</i>	<i>3rd</i>	<i>4th</i>
1. W	♠ 4	2	<u>K</u>	9
2. E	♠ <u>A</u>	J	6	Q
3. E	♦ 9	3	<u>A</u>	5
4. W	♦ 7	<u>J</u>	2	♣ 4
5. N	♥ 3	6	<u>A</u>	8
6. S	♥ 2	10	<u>J</u>	9
7. N	♥ <u>K</u>	♠ 5	4	Q
8. N	♦ <u>K</u>	♠ 7	♣ 6	4
9. N	♦ <u>Q</u>	♠ 8	♣ 8	6
10. N	♣ <u>A</u>	5	9	2
11. N	♥ 5	♠ 10	<u>7</u>	♠ 3
12. S	♣ J	♦ 8	<u>K</u>	3
13. N	♣ 7	<u>Q</u>	10	♦ 10

Down 1 — NS -50

**Board 1245**  
 West Deals  
 None Vul

♠ A J 6 2	♠ K 10	♠ Q 7 4 3
♥ K Q 10	♥ J 9 8	♥ A 7 6
♦ K 4 3	♦ Q 8 6 5 2	♦ A J 10 9
♣ A 4 2	♣ 9 8 6	♣ 10 5

♠ 9 8 5
♥ 5 4 3 2
♦ 7
♣ K Q J 7 3

EW 4N; EW 4♠; EW 4♥; EW 3♦; EW 1♣; Par -430

West	North	East	South
<i>vikordani</i>	<i>smispi</i>	<i>beccamin</i>	<i>jec</i>
1 NT	Pass	2 ♣	Dbl
2 ♠	Pass	4 ♠	Pass
Pass	Pass		

4 ♠ by West

<i>Trick</i>	<i>Lead</i>	<i>2nd</i>	<i>3rd</i>	<i>4th</i>
1. N	♣ 6	5	<u>Q</u>	2
2. S	♣ J	<u>A</u>	8	10
3. W	♥ 10	J	<u>A</u>	3
4. E	♠ 3	5	J	<u>K</u>
5. N	♥ 9	6	4	<u>K</u>
6. W	♠ 2	10	<u>Q</u>	8
7. E	♠ 4	9	<u>A</u>	♥ 8
8. W	♦ <u>K</u>	2	9	7
9. W	♦ 3	5	<u>10</u>	♣ 3

Made 5 — NS -450

**Board 1251**  
 East Deals  
 None Vul

♠ 10 8 3 ♥ 9 7 2 ♦ J 9 4 ♣ Q 6 5 3	♠ K J 4 2 ♥ K 3 ♦ A Q 7 3 ♣ J 4 2	♠ A 9 5 ♥ J 10 6 5 4 ♦ 10 2 ♣ A K 10	
	♠ Q 7 6 ♥ A Q 8 ♦ K 8 6 5 ♣ 9 8 7		

NS 3♠; NS 2N; NS 3♦; NS 2♣; NS 1♥; Par +140

West	North	East	South
<i>vikordani</i>	<i>smispi</i>	<i>beccamin</i>	<i>jec</i>
		1♥	Pass
Pass	1 NT	Pass	Pass

Pass

1 NT by North

<i>Trick</i>	<i>Lead</i>	<i>2nd</i>	<i>3rd</i>	<i>4th</i>
1. E	♥ 5	8	9	<u>K</u>
2. N	♠ 4	5	<u>Q</u>	3
3. S	♠ 6	8	<u>K</u>	9
4. N	♦ A	2	5	4
5. N	♦ Q	10	6	J
6. N	♦ 7	♣ 10	<u>K</u>	9
7. S	♦ 8	♣ 3	3	♥ 4

Made 3 — NS +150

**Board 1253**  
 West Deals  
 E-W Vul

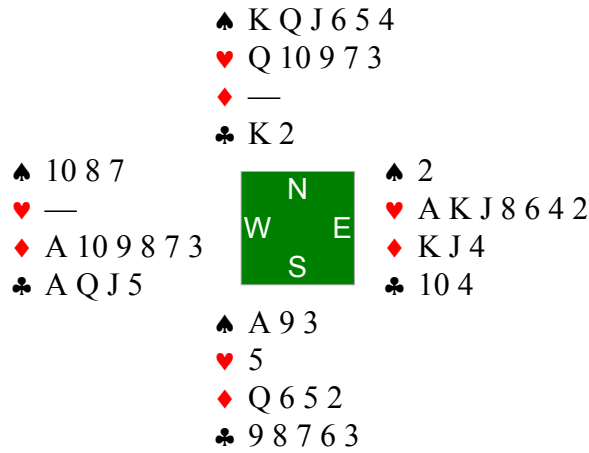

EW 5♦; NS 2♠; EW 2♥; W 3♣; EW 1N; E 2♣; Par -500:  
 NS 5♠×-3

West	North	East	South
<i>vikordani</i>	<i>smispi</i>	<i>beccamin</i>	<i>jec</i>
1 ♦	1 ♠	2 ♥	2 ♠
3 ♣	4 ♠	5 ♦	Pass
Pass	Pass		

5 ♦ by West

<i>Trick</i>	<i>Lead</i>	<i>2nd</i>	<i>3rd</i>	<i>4th</i>
1. N	♠ K	2	<u>A</u>	8
2. S	♠ 9	10	J	<u>♦ 4</u>
3. E	<u>♥ A</u>	5	♠ 7	3
4. E	♣ 10	3	5	<u>K</u>
5. N	♣ 2	4	6	<u>J</u>
6. W	♦ 3	♠ 4	<u>K</u>	2
7. E	<u>♦ J</u>	5	7	♥ 7

Down 1 — NS +100

**Board 1255**  
 East Deals  
 N-S Vul

♠ 9 8 2	♠ K 10 7 4	♠ 6
♥ A Q 8 3 2	♥ 6	♥ 10 9
♦ Q 9 3	♦ A K 6 4 2	♦ 8 7
♣ 8 3	♣ A 9 2	♣ K Q J 10 7 6 5 4
	<div style="display: inline-block; background-color: green; color: white; padding: 5px; text-align: center; margin: 5px;">             N              W     E              S           </div>	
	♠ A Q J 5 3	
	♥ K J 7 5 4	
	♦ J 10 5	
	♣ —	

NS 6♠; NS 6♦; NS 5N; NS 3♥; EW 2♣; Par +1100; EW 7♣×-5

West	North	East	South
<i>vikordani</i>	<i>smispi</i>	<i>beccamin</i>	<i>jec</i>
		5 ♣	Dbl
Pass	6 ♣	Pass	6 ♥
Pass	6 ♠	Pass	Pass
Dbl	Pass	Pass	Pass

6 ♠× by North

Trick	Lead	2nd	3rd	4th
1. E	♣ K	♠ J	3	2
2. S	♠ A	2	4	6
3. S	♦ 5	3	A	7
4. N	♠ 7	♣ 4	Q	8
5. S	♦ J	9	2	8
6. S	♠ 3	9	K	♣ 5

Made 6 — NS +1660

**Board 1257**  
 West Deals  
 Both Vul

♠ J 9 4 2 ♥ A Q 6 ♦ A K 2 ♣ A 9 4	<div style="background-color: green; color: white; padding: 5px; display: inline-block;">           N            W     E            S         </div>	♠ Q 10 5 ♥ 7 3 ♦ 10 6 4 ♣ K J 8 6 2	♠ 8 ♥ K 10 8 5 4 2 ♦ 9 8 7 3 ♣ 5 3
♠ A K 7 6 3 ♥ J 9 ♦ Q J 5 ♣ Q 10 7			

EW 4♥; W 3N; EW 4♦; E 2N; NS 2♠; NS 1♣; Par -500: NS 4♠×-2

West	North	East	South
<i>vikordani</i>	<i>smispi</i>	<i>beccamin</i>	<i>jec</i>
1 ♣	Pass	2 ♥ <sup>1</sup>	2 ♠
4 ♥	Pass	Pass	Pass

1. Weak:)

4 ♥ by East

<i>Trick</i>	<i>Lead</i>	<i>2nd</i>	<i>3rd</i>	<i>4th</i>
1. S	♠ <u>A</u>	2	5	8
2. S	♠ 3	4	10	<u>♥ 2</u>
3. E	♦ 3	5	<u>A</u>	4
4. W	♠ 9	Q	<u>♥ 4</u>	6
5. E	♦ 8	J	<u>K</u>	6
6. W	♦ 2	10	9	<u>Q</u>
7. S	♠ <u>K</u>	J	♣ 6	♣ 3
8. S	♥ 9	<u>A</u>	3	5

Made 4 — NS -620

**Board 1263**  
 East Deals  
 E-W Vul

♠ Q 6 2 ♥ 10 9 8 5 3 ♦ Q 4 2 ♣ 6 4	<div style="background-color: green; color: white; padding: 5px; width: 40px; height: 40px; margin: 0 auto; display: flex; flex-direction: column; align-items: center; justify-content: center;"> <span>N</span> <span>W</span> <span>E</span> <span>S</span> </div>	♠ 8 7 ♥ K ♦ K J 10 8 7 3 ♣ 8 7 3 2	♠ A K J 10 ♥ 7 4 2 ♦ 9 6 ♣ K Q J 9
		♠ 9 5 4 3 ♥ A Q J 6 ♦ A 5 ♣ A 10 5	

NS 3N; NS 5♦; NS 2♥; NS 3♣; NS 1♠; Par +400

West	North	East	South
<i>faramarz</i>	<i>smispi</i>	<i>abc36</i>	<i>jec</i>
		1 ♣	1 NT
Pass	3 ♣ <sup>1</sup>	Dbl	3 ♦
Pass	Pass	Pass	

1. D

3 ♦ by South

<i>Trick</i>	<i>Lead</i>	<i>2nd</i>	<i>3rd</i>	<i>4th</i>
1. W	♣ 6	2	J	<u>A</u>
2. S	♥ <u>A</u>	3	K	2
3. S	♥ <u>Q</u>	5	♠ 7	7
4. S	♥ <u>J</u>	8	♠ 8	4
5. S	♣ 10	4	3	<u>Q</u>
6. E	♣ <u>K</u>	5	♥ 10	7
7. E	♣ 9	♦ <u>A</u>	♥ 9	8
8. S	♦ 5	2	<u>10</u>	6
9. N	♦ <u>K</u>	9	♠ 3	4
10. N	♦ J	♠ A	♠ 4	<u>Q</u>
11. W	♠ 2	♦ <u>3</u>	10	5
12. N	♦ <u>8</u>	♠ J	♠ 9	♠ 6
13. N	♦ <u>7</u>	♠ K	♥ 6	♠ Q

Made 4 — NS +130

**Board 1265**  
 West Deals  
 None Vul

♠ 9 8 5 ♥ 10 6 2 ♦ A Q J 3 ♣ Q 7 6		♠ 7 6 2 ♥ 7 3 ♦ K 9 4 ♣ A J 4 3 2	♠ Q 3 ♥ A K J 5 4 ♦ 8 7 5 ♣ K 8 5
♠ A K J 10 4 ♥ Q 9 8 ♦ 10 6 2 ♣ 10 9			

NS 2♠; NS 1N; EW 1♥; W 1♦; NS 1♣; Par +110

West	North	East	South
<i>faramarz</i>	<i>smispi</i>	<i>abc36</i>	<i>jec</i>
Pass	Pass	1♥	1♠
2♥	2♠	Pass	Pass
3♥	Pass	Pass	Pass

3♥ by East

<i>Trick</i>	<i>Lead</i>	<i>2nd</i>	<i>3rd</i>	<i>4th</i>
1. S	<u>♠ A</u>	5	2	3
2. S	<u>♠ K</u>	8	6	Q
3. S	<u>♣ 10</u>	6	4	<u>K</u>
4. E	<u>♥ A</u>	9	2	3
5. E	<u>♦ 5</u>	2	<u>Q</u>	4
6. W	<u>♠ 9</u>	7	<u>♥ 4</u>	J
7. E	<u>♦ 7</u>	6	J	<u>K</u>
8. N	<u>♦ 9</u>	8	10	<u>A</u>
9. W	<u>♥ 6</u>	7	<u>K</u>	8
10. E	<u>♥ 5</u>	<u>Q</u>	10	♣ 2
11. S	<u>♣ 9</u>	7	<u>J</u>	5
12. N	<u>♣ A</u>	8	♠ 4	Q
13. N	<u>♣ 3</u>	<u>♥ J</u>	♠ 10	♦ 3

Down 2 — NS +100



**Board 1271**  
 East Deals  
 N-S Vul

♠ A Q ♥ 6 4 2 ♦ 10 8 7 5 ♣ A 5 4 3		♠ K 5 ♥ A 7 5 3 ♦ Q 9 4 3 ♣ 10 9 6	♠ J 9 8 7 6 3 2 ♥ 8 ♦ A J ♣ J 8 2
♠ 10 4 ♥ K Q J 10 9 ♦ K 6 2 ♣ K Q 7			

NS 4♥; EW 2♠; NS 3♦; NS 1♣; Par +300; EW 4♠×-2

West	North	East	South
<i>faramarz</i>	<i>BridgeGoth</i>	<i>PhilippeIV</i>	<i>jec</i>
		3 ♠	Dbl
4 ♠	Dbl	Pass	5 ♥
Pass	Pass	Pass	

5 ♥ by South

<i>Trick</i>	<i>Lead</i>	<i>2nd</i>	<i>3rd</i>	<i>4th</i>
1. W	♠ <u>A</u>	5	9	10
2. W	♠ <u>Q</u>	<u>K</u>	8	4
3. N	♣ 6	2	K	<u>A</u>
4. W	♣ 3	9	J	<u>Q</u>
5. S	♥ <u>Q</u>	2	3	8
6. S	♥ <u>K</u>	4	5	♠ 3
7. S	♥ 9	6	<u>A</u>	♠ 6
8. N	♦ 3	<u>A</u>	2	7
9. E	♣ 8	-	-	-

Down 1 — NS -100

**Board 1272**  
 South Deals  
 E-W Vul

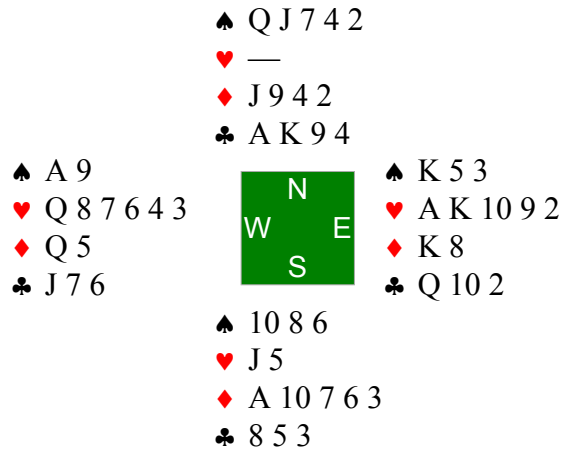

EW 4♥; EW 3N; NS 2♠; NS 3♦; Par -300; NS 4♠×-2; NS 5♦×-2

West	North	East	South
<i>faramarz</i>	<i>BridgeGoth</i>	<i>PhilippeIV</i>	<i>jec</i>
			Pass
2♦ <sup>1</sup>	2♥ <sup>2</sup>	2NT	Pass
3♦ <sup>3</sup>	Pass	4♥	Pass
Pass	Pass		

1. Wk ♥ or SF ♣/♦/♠
2. ♥ takeout
3. Wk ♥ 9-10

4♥ by East

Trick	Lead	2nd	3rd	4th
1. S	♠ 6	9	J	<u>K</u>
2. E	<u>♥ A</u>	5	3	♠ 2
3. E	<u>♥ K</u>	J	4	♠ 4

Made 4 — NS -620

**Board 1281**  
 West Deals  
 N-S Vul

♠ 10 9 3 2 ♥ 5 2 ♦ Q J 9 4 ♣ 8 5 4	♠ J 7 6 5 ♥ Q 8 7 4 3 ♦ 7 6 ♣ A J		♠ K Q 8 ♥ A 9 6 ♦ 10 3 ♣ K 10 7 6 3
♠ A 4 ♥ K J 10 ♦ A K 8 5 2 ♣ Q 9 2			

NS 4♥; N 3N; N 3♦; S 1N; S 2♦; NS 1♠; NS 1♣; Par +620

West	North	East	South
<i>faramarz</i>	<i>BridgeGoth</i>	<i>PhilippeIV</i>	<i>jec</i>
Pass	Pass	1 ♣	1 NT
Pass	2 ♦	Pass	2 ♥
Pass	2 ♠ <sup>1</sup>	Pass	4 ♥
Pass	Pass	Pass	

1. inv 5♥4♠

4♥ by South

<i>Trick</i>	<i>Lead</i>	<i>2nd</i>	<i>3rd</i>	<i>4th</i>
1. W	♣ 4	<u>A</u>	3	2
2. N	♣ J	<u>K</u>	9	8
3. E	♦ 3	<u>A</u>	4	6
4. S	♣ Q	5	♠ 5	6
5. S	♠ A	3	6	8
6. S	♠ 4	2	J	<u>K</u>
7. E	♦ 10	<u>K</u>	Q	7
8. S	♥ K	2	3	6
9. S	♦ 2	9	♥ 7	<u>♥ 9</u>
10. E	♣ 7	<u>♥ 10</u>	♠ 10	♠ 7
11. S	♥ J	5	4	<u>A</u>

Down 1 — NS -100

**Board 1283**  
 East Deals  
 None Vul

♠ Q J 7	♠ 6 5	♠ A K 9
♥ A 10 7	♥ K Q 6 2	♥ 9 8 5
♦ A 10 7 4 3 2	♦ K Q 8	♦ J 9 6 5
♣ J	♣ 9 7 6 5	♣ Q 4 2

N	
W	E
S	

♠ 10 8 4 3 2
♥ J 4 3
♦ —
♣ A K 10 8 3

S 4♣; NS 2N; S 2♠; NS 2♥; N 3♣; EW 2♦; N 1♠; Par +130

West	North	East	South
<i>faramarz</i>	<i>BridgeGoth</i>	<i>PhilippeIV</i>	<i>jec</i>
		Pass	Pass
1 ♦	Pass	2 ♣ <sup>1</sup>	Dbl
Pass	4 ♣	Pass	Pass
4 ♦	Dbl	Pass	4 ♠
Pass	5 ♣	Pass	Pass
Pass			

1. drury

5 ♣ by North

Trick	Lead	2nd	3rd	4th
1. E	♠ <u>K</u>	2	7	5
2. E	♣ 2	<u>A</u>	J	5
3. S	♥ 3	7	<u>Q</u>	5
4. N	♣ 6	4	<u>10</u>	♦ 3
5. S	♣ <u>K</u>	♦ 2	7	Q
6. S	♠ 3	<u>Q</u>	6	9
7. W	♥ <u>A</u>	2	9	4

Down 1 — NS -50

**Board 1285**  
 West Deals  
 E-W Vul

♠ 10 6 4 2		
♥ Q 9 7 5		
♦ 7		
♣ 9 7 5 2		
♠ Q 9 8 5 3	<div style="display: inline-block; background-color: green; color: white; padding: 5px; border: 1px solid black;">           N            W     E            S         </div>	♠ J 7
♥ 4 2		♥ J 6
♦ 5 3		♦ A K Q J 8 4
♣ K Q 6 3		♣ J 10 4
		♠ A K
		♥ A K 10 8 3
		♦ 10 9 6 2
		♣ A 8

NS 4♥; NS 1N; NS 1♠; EW 1♦; NS 1♣; Par +420

West	North	East	South
<i>faramarz</i>	<i>BridgeGoth</i>	<i>PhilippeIV</i>	<i>jec</i>
Pass	Pass	1♦	1♥
1♠	3♥	Pass	4♥
Pass	Pass	Pass	

4♥ by South

<i>Trick</i>	<i>Lead</i>	<i>2nd</i>	<i>3rd</i>	<i>4th</i>
1. W	♦ 5	7	<u>J</u>	10
2. E	♠ J	<u>A</u>	3	2
3. S	♦ 2	3	<u>♥ 5</u>	4
4. N	♠ 4	7	<u>K</u>	5
5. S	♦ 6	♠ 8	<u>♥ 7</u>	8
6. N	♠ 6	♦ Q	<u>♥ 3</u>	9
7. S	♦ 9	♣ 3	<u>♥ 9</u>	K
8. N	♠ 10	♥ J	<u>♥ K</u>	Q

Made 5 — NS +450

**Board 1288**  
 South Deals  
 E-W Vul

♠ 10 6	♠ Q J 8 7 5	♠ 3 2
♥ Q 3	♥ K 9 6 5	♥ A
♦ A 10 9 6 4 3	♦ 7 2	♦ K Q J 8
♣ Q 9 6	♣ K 3	♣ A J 10 7 5 2

♠ A K 9 4
♥ J 10 8 7 4 2
♦ 5
♣ 8 4

EW 5♦; EW 5♣; NS 3♥; EW 2N; NS 2♠; Par -300; NS 5♥×-2

West	North	East	South
<i>faramarz</i>	<i>BridgeGoth</i>	<i>PhilippeIV</i>	<i>jec</i>
			Pass
2♣ <sup>1</sup>	Pass	2♦	2♥
Pass	Pass	5♦	Pass
Pass	5♥	Dbl	Pass
Pass	Pass		

1. Wk ♦ or GF

5♥× by South

<i>Trick</i>	<i>Lead</i>	<i>2nd</i>	<i>3rd</i>	<i>4th</i>
1. W	♦ <u>A</u>	2	8	5
2. W	♦ 3	7	J	♥ <u>2</u>
3. S	♥ 7	3	5	<u>A</u>
4. E	♠ 3	<u>A</u>	6	5
5. S	♥ 4	Q	<u>K</u>	♣ 5

Down 1 — NS -100

**Board 1293**  
 West Deals  
 None Vul

♠ K Q 10 5 3 ♥ Q 10 8 4 ♦ 10 ♣ 7 3 2		♠ J 8 6 ♥ 9 7 ♦ 9 5 4 ♣ A 9 8 6 4	♠ A 7 ♥ J 5 3 2 ♦ J 7 6 2 ♣ K Q J
		♠ 9 4 2 ♥ A K 6 ♦ A K Q 8 3 ♣ 10 5	

EW 2♥; NS 3♦; EW 1♠; NS 1♣; Par +100: EW 3♥×-1

West	North	East	South
<i>faramarz</i>	<i>BridgeGoth</i>	<i>PhilippeIV</i>	<i>jec</i>
Pass	Pass	1 ♣	1 ♦
1 ♠	Pass	1 NT	Pass
2 ♥	Pass	Pass	Pass

2 ♥ by West

<i>Trick</i>	<i>Lead</i>	<i>2nd</i>	<i>3rd</i>	<i>4th</i>
1. N	♦ 4	2	<u>A</u>	10
2. S	♦ 8	<u>♥ 4</u>	5	6
3. W	♥ 10	7	2	<u>K</u>
4. S	♦ Q	<u>♥ 8</u>	9	7
5. W	♠ 3	6	<u>A</u>	2
6. E	♠ 7	9	<u>K</u>	8
7. W	<u>♠ Q</u>	J	♦ J	4
8. W	♣ 2	<u>A</u>	J	10
9. N	♣ 6	<u>K</u>	5	3
10. E	♥ 3	<u>A</u>	Q	9
11. S	♦ K	♣ 7	♣ 4	<u>♥ 5</u>
12. E	♥ J	6	-	-

Made 3 — NS -140

**Board 1295**

East Deals  
Both Vul

♠ 8	♠ 9 7 6 5 4 3	♠ A K 10
♥ Q 6 5 2	♥ A 9	♥ J 10 8 3
♦ Q 10 6 4	♦ A K J	♦ 5 3 2
♣ A K J 6	♣ 10 3	♣ 9 8 4

♠ Q J 2
♥ K 7 4
♦ 9 8 7
♣ Q 7 5 2

NS 3♠; EW 2♥; EW 1♦; W 1♣; Par +140

West	North	East	South
<i>faramarz</i>	<i>BridgeGoth</i>	<i>PhilippeIV</i>	<i>jec</i>
		Pass	Pass
1♦	1♠	1NT	2♠
Pass	Pass	Pass	

2♠ by North

<i>Trick</i>	<i>Lead</i>	<i>2nd</i>	<i>3rd</i>	<i>4th</i>
1. E	♦ 2	7	Q	<u>A</u>
2. N	♠ 4	<u>K</u>	2	8
3. E	♥ J	4	5	<u>A</u>
4. N	♠ 5	<u>A</u>	J	♦ 4
5. E	♣ 4	2	<u>J</u>	3
6. W	♦ 6	<u>K</u>	5	8
7. N	♠ 3	10	<u>Q</u>	♥ 2

Made 3 — NS +140



**Board 1298**  
 North Deals  
 None Vul

♠ Q	♠ K 10 5 4 3	♠ J 9 2
♥ K 7 6	♥ 10 9 8 5	♥ 4 3
♦ A Q 6 4 2	♦ 10 5	♦ K 3
♣ A J 8 7	♣ 9 3	♣ K Q 10 6 4 2

♠ A 8 7 6
♥ A Q J 2
♦ J 9 8 7
♣ 5

EW 4N; EW 5♣; NS 2♥; EW 3♦; NS 1♠; Par -430

West	North	East	South
<i>carlosp</i>	<i>nevaio</i>	<i>hectorc</i>	<i>jec</i>
	Pass	3 ♣	Dbl
5 ♣	Pass	Pass	Pass

5 ♣ by East

<i>Trick</i>	<i>Lead</i>	<i>2nd</i>	<i>3rd</i>	<i>4th</i>
1. S	♥ <u>A</u>	6	10	4
2. S	♠ <u>A</u>	Q	5	9
3. S	♥ <u>Q</u>	<u>K</u>	5	3
4. W	♣ 7	3	-	-

Made 5 — NS -400

**Board 1300**  
 South Deals  
 E-W Vul

♠ A J 9 4	♠ K 7 6 5 2	♠ —
♥ K Q 3 2	♥ 6	♥ A J 9 8 4
♦ K 10 7	♦ A J 2	♦ Q 9 8 5 4
♣ 8 2	♣ A 6 5 3	♣ Q 10 7

♠ Q 10 8 3
♥ 10 7 5
♦ 6 3
♣ K J 9 4

EW 4♥; NS 2♠; EW 1N; EW 2♦; NS 2♣; Par -300; NS 4♠×-2

West	North	East	South
<i>carlosp</i>	<i>nevaio</i>	<i>hectorc</i>	<i>jec</i>
			Pass
1 ♣ <sup>1</sup>	1 ♠	Dbl	3 ♠
Pass	Pass	Dbl	Pass
4 ♥	Dbl	Pass	Pass
Pass			

1. 2+

4 ♥× by West

Trick	Lead	2nd	3rd	4th
1. N	♠ 2	♣ 7	Q	<u>A</u>
2. W	♥ 3	6	<u>J</u>	5
3. E	♥ 4	7	<u>K</u>	♠ 5
4. W	♥ 2	♣ 5	<u>A</u>	10
5. E	♦ 4	3	K	<u>A</u>
6. N	♣ <u>A</u>	10	9	2
7. N	♣ 3	Q	<u>K</u>	8
8. S	♠ 3	9	K	♥ 8
9. E	♥ 9	♠ 8	<u>Q</u>	♣ 6
10. W	♦ <u>10</u>	2	5	6
11. W	♦ 7	J	-	-

Made 4 — NS -790

**Board 1307**  
 East Deals  
 Both Vul

♠ A 8 ♥ A 4 ♦ Q 9 4 3 ♣ A 9 8 5 3	♠ K 5 ♥ K Q J 9 7 3 ♦ 7 6 ♣ K J 7	<div style="text-align: center; border: 1px solid black; width: 40px; height: 40px; margin: 0 auto; background-color: #006400; color: white; display: flex; flex-direction: column; align-items: center; justify-content: center;"> <span>N</span> <span>W</span> <span>S</span> <span>E</span> </div>	♠ 10 9 6 3 ♥ 10 8 6 5 ♦ A 10 2 ♣ 10 4
♠ Q J 7 4 2 ♥ 2 ♦ K J 8 5 ♣ Q 6 2			

NS 2♥; NS 1N; NS 1♠; EW 1♦; EW 1♣; Par +110

West	North	East	South
<i>carlosp</i>	<i>nevaio</i>	<i>hectorc</i>	<i>jec</i>
		Pass	Pass
1 ♣	1 ♥	Pass	1 ♠
Pass	2 ♥	Pass	Pass

Pass

2 ♥ by North

<i>Trick</i>	<i>Lead</i>	<i>2nd</i>	<i>3rd</i>	<i>4th</i>
1. E	♣ 10	2	<u>A</u>	7
2. W	♣ 9	J	4	<u>Q</u>
3. S	♥ 2	4	<u>K</u>	5
4. N	♥ J	6	♦ 5	<u>A</u>
5. W	♣ 8	K	<u>♥ 8</u>	6
6. E	♠ 6	2	<u>A</u>	K
7. W	♣ 3	♥ 9	<u>♥ 10</u>	♠ 4
8. E	♦ A	-	-	-

Down 1 — NS -100

**Board 1310**  
 North Deals  
 Both Vul

♠ A K 10	♠ Q J 7 5	♠ —
♥ K 8 5 4	♥ 10 9	♥ J 7 3 2
♦ 7 2	♦ Q 8 4	♦ K 10 9 6 3
♣ K J 9 8	♣ 6 5 4 2	♣ A Q 7 3

♠ 9 8 6 4 3 2
♥ A Q 6
♦ A J 5
♣ 10

EW 3♥; EW 4♦; EW 4♣; NS 2♠; EW 1N; Par -140

West	North	East	South
<i>carlosp</i>	<i>nevaio</i>	<i>hectorc</i>	<i>jec</i>
	Pass	1♦	1♠
Dbl	3♠	Pass	Pass
3NT	Pass	4♥	Pass
Pass	Pass		

4♥ by East

Trick	Lead	2nd	3rd	4th
1. S	♣ 10	8	6	<u>A</u>
2. E	♥ 2	6	<u>K</u>	9
3. W	♥ 4	10	J	<u>Q</u>
4. S	♥ <u>A</u>	5	♠ Q	3
5. S	♠ 2	<u>A</u>	5	♦ 3
6. W	♦ 2	4	K	<u>A</u>

Down 1 — NS +100

**Board 1311**  
 East Deals  
 None Vul

♠ 6 4 2	♠ 10 7 3	♠ A Q J 5
♥ 7 5	♥ K J 8 2	♥ 10 9 6
♦ 7	♦ J 10 8	♦ A 9 6 5 2
♣ K Q 10 9 8 5 2	♣ A 7 4	♣ J

N
W      E
S

♠ K 9 8
♥ A Q 4 3
♦ K Q 4 3
♣ 6 3

NS 3N; NS 2♥; EW 3♣; NS 2♦; Par +100; EW 4♣×-1

West	North	East	South
<i>carlosp</i>	<i>nevaio</i>	<i>hectorc</i>	<i>jec</i>
		1 ♦	Pass
1 NT	Pass	Pass	Dbl
2 ♣	2 ♥	Pass	Pass
3 ♣	Pass	Pass	3 ♥
Pass	Pass	Pass	

3 ♥ by North

Trick	Lead	2nd	3rd	4th
1. E	♣ J	3	Q	<u>A</u>
2. N	♥ J	6	3	5
3. N	♥ 2	9	<u>A</u>	7
4. S	♥ 4	♣ 2	<u>K</u>	10
5. N	♦ J	<u>A</u>	3	7
6. E	♦ 2	4	♣ 5	<u>8</u>
7. N	♠ 3	5	<u>K</u>	6
8. S	♦ Q	♣ 8	-	-

Made 4 — NS +170

**Board 1313**  
West Deals  
E-W Vul

	♠ 8 6 4 3		
	♥ 8 5 2		
	♦ 9 8 6 4		
	♣ 6 4		
♠ 9 5 ♥ A 9 7 6 4 ♦ K 3 ♣ J 8 7 3	<div style="border: 2px solid green; padding: 5px; display: inline-block;">           N W     E S         </div>	♠ K J 10 7 ♥ Q J ♦ 7 ♣ A K 10 9 5 2	
	♠ A Q 2		
	♥ K 10 3		
	♦ A Q J 10 5 2		
	♣ Q		

E 4♥; EW 3N; E 5♣; W 3♥; W 4♣; NS 2♦; EW 1♠; Par -500:  
NS 5♦×-3

West	North	East	South
<i>carlosp</i>	<i>nevaio</i>	<i>hectorc</i>	<i>jec</i>
Pass	Pass	1 ♣	1 ♦
Dbl <sup>1</sup>	3 ♦	Pass	Pass

Pass  
1. ♥ 4+

3 ♦ by South

<i>Trick</i>	<i>Lead</i>	<i>2nd</i>	<i>3rd</i>	<i>4th</i>
1. W	♣ 7	4	<u>K</u>	Q
2. E	♥ Q	K	<u>A</u>	2
3. W	♥ 6	5	<u>J</u>	3
4. E	♣ A	<u>♦ 2</u>	3	6
5. S	<u>♦ A</u>	3	4	7
6. S	<u>♥ 10</u>	7	8	♣ 2
7. S	<u>♦ 10</u>	<u>K</u>	6	♣ 5
8. W	♠ 9	3	7	<u>Q</u>

Down 1 — NS -50

**Board 1315**  
 East Deals  
 N-S Vul

♠ J 10 8 4 ♥ K 7 5 4 ♦ 6 ♣ 10 8 4 3	<div style="background-color: green; color: white; padding: 5px; display: inline-block;">           N W     E S         </div>	♠ A K Q 6 ♥ A 2 ♦ 9 8 3 ♣ K J 7 6	♠ 5 ♥ Q J 10 9 3 ♦ A K J 7 5 ♣ 9 5
		♠ 9 7 3 2 ♥ 8 6 ♦ Q 10 4 2 ♣ A Q 2	

NS 4♠; EW 3♥; NS 2N; NS 2♦; NS 2♣; Par +300; EW 5♥×-2

West	North	East	South
<i>carlosp</i>	<i>nevaio</i>	<i>hectorc</i>	<i>jec</i>
		1 ♥	Pass
3 ♥ <sup>1</sup>	Dbl	4 ♥	4 ♠
Pass	Pass	5 ♦	Dbl
5 ♥	Dbl	Pass	Pass
Pass			

1. weak

5 ♥× by East

Trick	Lead	2nd	3rd	4th
1. S	♠ 3	4	<u>A</u>	5
2. N	♣ 6	5	<u>Q</u>	3
3. S	<u>♣ A</u>	4	7	9
4. S	♣ 2	8	K	<u>♥ 3</u>
5. E	♥ Q	6	4	<u>A</u>
6. N	♣ J	<u>♥ 9</u>	♠ 2	10
7. E	<u>♦ A</u>	2	6	3
8. E	<u>♦ K</u>	4	♠ 8	8
9. E	♦ 5	10	<u>♥ 5</u>	9
10. W	♠ 10	Q	<u>♥ 10</u>	9
11. E	♦ 7	Q	<u>♥ K</u>	♠ 6
12. W	♥ 7	2	<u>J</u>	8
13. E	<u>♦ J</u>	♠ 7	♠ J	♠ K

Down 2 — NS +300

**Board 1321**  
 West Deals  
 None Vul

♠ A K J 6 ♥ A 9 6 ♦ Q 9 6 2 ♣ 5 2		♠ Q 7 2 ♥ 8 5 4 ♦ J 4 3 ♣ J 10 4 3	♠ 10 9 8 5 4 ♥ Q J 3 ♦ K 8 5 ♣ A 8
♠ 3 ♥ K 10 7 2 ♦ A 10 7 ♣ K Q 9 7 6			

EW 3♠; EW 1N; EW 2♦; E 1♥; NS 1♣; Par -140

West	North	East	South
<i>carlosp</i>	<i>nevaio</i>	<i>hectorc</i>	<i>jec</i>
1 ♦	Pass	1 ♠	Dbl
2 ♠	Pass	4 ♠	Pass
Pass	Pass		

4 ♠ by East

<i>Trick</i>	<i>Lead</i>	<i>2nd</i>	<i>3rd</i>	<i>4th</i>
1. S	♣ K	2	4	<u>A</u>
2. E	♠ 4	3	<u>A</u>	2
3. W	<u>♠ K</u>	7	10	♥ 2
4. W	♣ 5	<u>J</u>	8	7
5. N	<u>♠ Q</u>	8	♣ 6	J
6. N	♥ 5	Q	K	<u>A</u>
7. W	♦ 2	3	K	<u>A</u>
8. S	♦ 10	<u>Q</u>	4	5
9. W	♦ 6	<u>J</u>	8	7
10. N	♥ 4	-	-	-

Down 1 — NS +50



**Board 1327**  
 East Deals  
 N-S Vul

♠ 9 3 2 ♥ J 10 8 ♦ 9 5 4 2 ♣ Q 10 2	♠ J 10 8 6 ♥ A Q 9 ♦ 3 ♣ A K 8 5 4		♠ K 7 ♥ 7 3 2 ♦ A K Q 10 8 7 ♣ 7 6
	♠ A Q 5 4 ♥ K 6 5 4 ♦ J 6 ♣ J 9 3		

NS 6♠; NS 6♥; NS 6♣; NS 1N; NS 1♦; Par +1430

West	North	East	South
<i>beccamin</i>	<i>smispi</i>	<i>Harmon</i>	<i>jec</i>
		1♦	Pass
Pass	Dbl	2♦	3♦
Pass	4♠	Pass	Pass

Pass

4♠ by North

<i>Trick</i>	<i>Lead</i>	<i>2nd</i>	<i>3rd</i>	<i>4th</i>
1. E	♦ <u>A</u>	6	5	3
2. E	♦ K	J	2	♠ <u>6</u>
3. N	♠ 8	7	Q	2
4. S	♥ 4	10	<u>A</u>	2
5. N	♠ 10	K	<u>A</u>	3
6. S	♣ J	Q	<u>A</u>	6
7. N	♠ <u>J</u>	♦ 7	4	9
8. N	♥ 9	3	<u>K</u>	J
9. S	♣ 9	2	4	7

Made 6 — NS +680

**Board 1331**  
 East Deals  
 E-W Vul

♠ K 7 6	♠ Q 4	♠ A 10 9 5 2
♥ 9 4	♥ A Q 6 5	♥ J 10 8 7 2
♦ Q J 10 9 6 5 3	♦ K 7 4	♦ A
♣ 2	♣ K Q 5 4	♣ 9 6

N
W      E
S

♠ J 8 3
♥ K 3
♦ 8 2
♣ A J 10 8 7 3

NS 4N; EW 2♠; NS 3♣; EW 2♦; NS 1♥; Par +430

West	North	East	South
<i>beccamin</i>	<i>smispi</i>	<i>Harmon</i>	<i>jec</i>
		Pass	Pass
2♦ <sup>1</sup>	2NT	Pass	3NT
Pass	Pass	Pass	

1. Weak with diamonds.

3NT by North

Trick	Lead	2nd	3rd	4th
1. E	♥ 7	<u>K</u>	9	6
2. S	♣ 3	2	<u>K</u>	9
3. N	♣ Q	6	7	♦ 3
4. N	♣ 5	♠ 2	<u>A</u>	♥ 4
5. S	♣ J	♦ 5	4	♠ 5
6. S	♣ 10	♦ 6	♦ 4	♠ 9
7. S	♣ 8	♦ 9	♠ 4	♠ 10
8. S	♥ 3	♠ 6	<u>A</u>	2
9. N	♥ Q	-	-	-

Made 3 — NS +400

**Board 1332**  
 South Deals  
 Both Vul

♠ J 4 3 ♥ 9 6 3 ♦ A 9 7 ♣ A J 9 4	♠ 10 9 6 2 ♥ K 4 2 ♦ J 8 5 ♣ Q 6 5	<div style="text-align: center; border: 1px solid black; width: 40px; height: 40px; margin: 0 auto; background-color: #006400; color: white; display: flex; flex-direction: column; align-items: center; justify-content: center;"> <span>N</span> <span>W</span> <span>E</span> <span>S</span> </div>	♠ K 8 7 ♥ A Q J 5 ♦ 10 4 ♣ K 10 7 3
	♠ A Q 5 ♥ 10 8 7 ♦ K Q 6 3 2 ♣ 8 2		

EW 3N; EW 3♥; EW 4♣; EW 2♠; EW 1♦; Par -600

West	North	East	South
<i>beccamin</i>	<i>smispi</i>	<i>Harmon</i>	<i>jec</i>
			Pass
Pass	Pass	1 ♣	1 ♦
1 NT	Pass	Pass	Pass

1 NT by West

<i>Trick</i>	<i>Lead</i>	<i>2nd</i>	<i>3rd</i>	<i>4th</i>
1. N	♦ 5	4	<u>Q</u>	7
2. S	♦ 3	9	<u>J</u>	10
3. N	♦ 8	♠ 7	K	<u>A</u>
4. W	♣ A	5	3	2
5. W	♣ 9	Q	<u>K</u>	8
6. E	♣ 10	♥ 7	4	6
7. E	♣ 7	♥ 8	<u>J</u>	♠ 9
8. W	♥ 3	2	<u>Q</u>	10
9. E	♥ A	♠ 5	6	4
10. E	♥ 5	♠ Q	9	<u>K</u>
11. N	♠ 2	K	-	-

Made 1 — NS -90

**Board 1333**  
 West Deals  
 None Vul

♠ K	<div style="background-color: green; color: white; padding: 10px; display: inline-block;">           N W     E S         </div>	♠ 8 7 2
♥ Q 9 8 7		♥ A J 10 4 2
♦ Q 4		♦ J 5
♣ A Q J 9 8 2		♣ 10 5 3
♠ A J 10 6 5 3		♠ —
♥ —		♥ A K 8 3
♦ A K 8 3		♦ K 7 4
♣ K 7 4		

NS 6♠; NS 6♦; EW 4♥; E 3♣; W 2♣; Par +500: EW 7♥×-3

West	North	East	South
<i>beccamin</i>	<i>smispi</i>	<i>Harmon</i>	<i>jec</i>
1 ♣	Pass	1 ♥	Dbl
3 ♥	4 ♦	Pass	4 ♠
Pass	Pass	Pass	

4 ♠ by South

<i>Trick</i>	<i>Lead</i>	<i>2nd</i>	<i>3rd</i>	<i>4th</i>
1. W	♥ 7	3	10	<u>♠ 3</u>
2. S	♠ 5	<u>K</u>	4	2
3. W	♥ 8	5	2	<u>♠ 10</u>
4. S	<u>♦ A</u>	4	2	5
5. S	♠ 6	♣ 2	<u>9</u>	7
6. N	♦ 10	J	<u>K</u>	Q
7. S	♠ J	♣ 8	Q	8
8. N	♦ 6	♣ 3	<u>8</u>	♣ 9

Made 4 — NS +420

**Board 1343**

East Deals  
N-S Vul

♠ A Q 6 3	<div style="display: inline-block; background-color: #008000; color: white; padding: 10px; border: 1px solid black;">             N W     E S           </div>	♠ K J 9 8 7 5
♥ 10 9 3 2		♥ —
♦ K 5 4		♦ A J
♣ J 7		♣ A 10 6 3 2
	♠ 10 4 2	
	♥ Q J 8 7 5	
	♦ Q 8 7 2	
	♣ 8	

W 6♠; E 5♠; NS 3♥; EW 2N; NS 3♦; EW 3♣; Par -980

West	North	East	South
<i>beccamin</i>	<i>smispi</i>	<i>Harmon</i>	<i>jec</i>
		1 ♠	Pass
3 ♠	Dbl	4 ♦	4 ♥
4 ♠	Pass	6 ♠	Pass
Pass	Pass		

6 ♠ by East

<i>Trick</i>	<i>Lead</i>	<i>2nd</i>	<i>3rd</i>	<i>4th</i>
1. S	♣ 8	7	Q	<u>A</u>

Made 6 — NS -980

**Board 1344**  
 South Deals  
 E-W Vul

♠ A Q J 4 ♥ Q J 8 7 5 ♦ K 8 ♣ 4 3		♠ 10 7 3 ♥ A 10 ♦ A Q J 10 ♣ A 9 8 5	♠ 9 6 5 ♥ K 2 ♦ 9 7 6 3 ♣ Q J 10 6
		♠ K 8 2 ♥ 9 6 4 3 ♦ 5 4 2 ♣ K 7 2	

NS 1N; NS 1♦; NS 1♣; Par +90

West	North	East	South
<i>beccamin</i>	<i>smispi</i>	<i>Harmon</i>	<i>jec</i>
			Pass
1 ♥	1 NT	Pass	Pass

Pass

1 NT by North

<i>Trick</i>	<i>Lead</i>	<i>2nd</i>	<i>3rd</i>	<i>4th</i>
1. E	♣ Q	2	4	<u>A</u>
2. N	♣ 5	10	<u>K</u>	3
3. S	♦ 2	K	<u>A</u>	7
4. N	♣ 8	<u>J</u>	7	♥ 8
5. E	♥ K	3	5	<u>A</u>
6. N	♦ Q	3	4	8
7. N	♦ J	6	5	♠ 4
8. N	♦ 10	9	♠ 2	♠ J
9. N	♣ 9	6	♥ 4	♥ J
10. N	♥ 10	2	6	<u>Q</u>
11. W	♥ 7	♠ 3	♠ 5	<u>9</u>
12. S	♠ 8	<u>Q</u>	7	6
13. W	♠ A	10	9	K

Made 3 — NS +150

**Board 1345**  
 West Deals  
 Both Vul

♠ 6 5 ♥ A K Q J 3 ♦ 8 2 ♣ J 8 7 5	<div style="border: 1px solid black; width: 40px; height: 40px; margin: 0 auto; background-color: #006400; color: white; display: flex; flex-direction: column; align-items: center; justify-content: center;"> <span style="margin-bottom: 5px;">N</span> <span style="margin-bottom: 5px;">W</span> <span style="margin-bottom: 5px;">E</span> <span>S</span> </div>	♠ K 8 2 ♥ 10 9 8 4 ♦ K 5 ♣ 10 9 6 2	♠ Q J 9 ♥ 6 5 ♦ Q J 10 9 ♣ K Q 4 3
♠ A 10 7 4 3 ♥ 7 2 ♦ A 7 6 4 3 ♣ A			

NS 4♠; NS 2♦; EW 1♣; Par +620

West	North	East	South
<i>beccamin</i>	<i>smispi</i>	<i>Harmon</i>	<i>jec</i>
1 ♥	Pass	1 NT	2 ♦ <sup>1</sup>
Pass	2 ♠	Dbl <sup>2</sup>	Pass
3 ♣	Pass	Pass	Dbl
Pass	3 ♦	Pass	Pass
Pass			

1. d+s

2. cards I didnt bid 1s

3 ♦ by South

Trick	Lead	2nd	3rd	4th
1. W	<u>♥ A</u>	4	5	2
2. W	<u>♥ K</u>	8	6	7
3. W	<u>♥ Q</u>	9	♣ 3	<u>♦ 3</u>
4. S	♠ 3	6	<u>K</u>	9
5. N	♠ 2	J	<u>A</u>	5
6. S	♠ 4	<u>♦ 2</u>	8	Q
7. W	<u>♥ J</u>	10	♣ 4	<u>♦ 4</u>
8. S	♦ 6	8	<u>K</u>	9
9. N	♦ 5	10	<u>A</u>	♥ 3
10. S	♠ 10	♣ 5	♣ 2	<u>♦ J</u>
11. E	<u>♦ Q</u>	7	♣ 7	♣ 6
12. E	♣ K	<u>A</u>	8	9
13. S	<u>♠ 7</u>	♣ J	♣ 10	♣ Q

Down 1 — NS -100

**Board 1346**  
 North Deals  
 None Vul

♠ 6 5 2 ♥ K 9 6 3 ♦ 5 3 ♣ 9 8 3 2	♠ A Q 10 7 3 ♥ 10 8 7 2 ♦ K J 7 ♣ 10		♠ J 4 ♥ J 5 ♦ A 6 ♣ A K Q J 6 5 4
	♠ K 9 8 ♥ A Q 4 ♦ Q 10 9 8 4 2 ♣ 7		

NS 4♠; NS 4♦; NS 2♥; EW 3♣; EW 1N; Par +300; EW 5♣×-2

West	North	East	South
<i>canalla</i>	<i>smispi</i>	<i>karuna</i>	<i>jec</i>
	Pass	1 ♣	1 ♦
Pass	1 ♠	3 ♣	Dbl
Pass	4 ♠	Pass	Pass

Pass

4 ♠ by North

<i>Trick</i>	<i>Lead</i>	<i>2nd</i>	<i>3rd</i>	<i>4th</i>
1. E	<u>♣ A</u>	7	9	10
2. E	<u>♥ J</u>	<u>A</u>	6	2
3. S	<u>♠ 8</u>	2	<u>Q</u>	4
4. N	<u>♠ 3</u>	J	<u>K</u>	5
5. S	<u>♠ 9</u>	6	7	♣ 4
6. S	<u>♦ 2</u>	5	K	<u>A</u>
7. E	<u>♥ 5</u>	4	K	-

Made 4 — NS +420



**Board 1348**  
 South Deals  
 E-W Vul

♠ K 9 ♥ Q 10 3 2 ♦ 7 6 3 2 ♣ J 10 5	♠ A 7 6 4 ♥ A 5 ♦ 10 9 5 ♣ 7 6 4 3		♠ Q J 10 8 2 ♥ K 4 ♦ A 8 ♣ K Q 9 2
♠ 5 3 ♥ J 9 8 7 6 ♦ K Q J 4 ♣ A 8			

EW 2♠; EW 1N; EW 2♣; NS 1♥; NS 1♦; Par -110

West	North	East	South	
<i>canalla</i>	<i>smispi</i>	<i>karuna</i>	<i>jec</i>	
			Pass	
Pass	Pass	1 ♠	Pass	
1 NT	Pass	2 ♣	Dbl	
2 ♠	Pass	Pass	Pass	
2 ♠ by East				
<i>Trick</i>	<i>Lead</i>	<i>2nd</i>	<i>3rd</i>	<i>4th</i>
1. S	♦ K	2	5	<u>A</u>
2. E	♥ 4	6	Q	<u>A</u>
3. N	♦ 10	8	4	3
4. N	♦ 9	<u>♠ 2</u>	J	6
5. E	<u>♣ K</u>	8	5	6
6. E	<u>♥ K</u>	7	2	5
7. E	♣ 2	<u>A</u>	J	3
8. S	♦ Q	7	♣ 4	<u>♠ 8</u>
9. E	♣ 9	<u>♠ 3</u>	10	7
10. S	♥ J	-	-	-
Made 2 — NS -110				

**Board 1350**  
 North Deals  
 N-S Vul

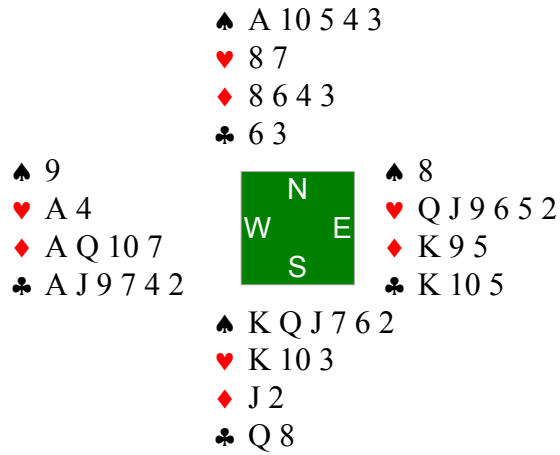

EW 6♦; EW 6♣; EW 5♥; EW 1N; NS 1♠; Par -920

West	North	East	South
<i>canalla</i>	<i>smispi</i>	<i>karuna</i>	<i>jec</i>
	Pass	2♥	2♠
4♥	4♠	Pass	Pass
Dbl	Pass	Pass	Pass

4♠× by South

<i>Trick</i>	<i>Lead</i>	<i>2nd</i>	<i>3rd</i>	<i>4th</i>
1. W	♥ A	7	Q	3
2. W	♥ 4	8	J	<u>K</u>
3. S	♠ K	9	3	8
4. S	♥ 10	♣ 4	♣ 3	2

Down 1 — NS -200

**Board 1353**

West Deals  
None Vul

	♠ 5 2		
	♥ Q 6		
	♦ J 6 5		
	♣ K 9 7 5 3 2		
♠ J 10		♠ A Q 8 6 4 3	
♥ K J		♥ 10 8 3	
♦ K Q 7 2		♦ A 10 4	
♣ A J 10 6 4		♣ Q	
	♠ K 9 7		
	♥ A 9 7 5 4 2		
	♦ 9 8 3		
	♣ 8		

EW 5N; EW 5♠; EW 5♦; EW 2♣; EW 1♥; Par -460

West	North	East	South
<i>canalla</i>	<i>smispi</i>	<i>karuna</i>	<i>jec</i>
1 NT	Pass	2 ♥	Dbl
Pass	Pass	4 ♥	Pass
4 ♠	Pass	Pass	Pass

4 ♠ by West

Trick	Lead	2nd	3rd	4th
1. N	♥ Q	3	<u>A</u>	J
2. S	♥ 2	<u>K</u>	6	8
3. W	♠ J	2	3	<u>K</u>
4. S	♥ 4	<u>♠ 10</u>	♣ 3	10
5. W	♦ 2	5	<u>A</u>	3
6. E	<u>♠ A</u>	7	♣ 4	5
7. E	<u>♠ Q</u>	9	♣ 6	♣ 2

Made 5 — NS -450

**Board 1359**  
 East Deals  
 N-S Vul

♠ A K Q 2	♠ 8	♠ 9 7 5
♥ 8 6 4 2	♥ A 10 7 5	♥ K Q
♦ 8	♦ A Q 7 4 3	♦ 10 9 6 5 2
♣ K Q 5 4	♣ 8 6 2	♣ A J 9

♠ J 10 6 4 3
♥ J 9 3
♦ K J
♣ 10 7 3

EW 2N; EW 2♠; EW 2♣; EW 1♥; EW 1♦; Par -120

West	North	East	South
<i>nathan2008</i>	<i>BridgeGoth</i>	<i>wellmax</i>	<i>jec</i>
		Pass	Pass
1 ♣	1 ♦	1 NT	Pass
Pass	Pass		

1 NT by East

<i>Trick</i>	<i>Lead</i>	<i>2nd</i>	<i>3rd</i>	<i>4th</i>
1. S	♠ 4	<u>A</u>	8	5
2. W	♥ 2	5	<u>Q</u>	3
3. E	<u>♣ A</u>	3	4	2
4. E	<u>♣ J</u>	7	5	6
5. E	♣ 9	10	<u>K</u>	8
6. W	<u>♣ Q</u>	♦ 3	♠ 7	♥ 9
7. W	<u>♠ K</u>	♦ 4	9	6
8. W	<u>♠ Q</u>	♥ 7	♦ 2	3
9. W	♦ 8	7	5	<u>J</u>
10. S	♠ J	2	♥ 10	♦ 6
11. S	<u>♠ 10</u>	♥ 4	♦ Q	♦ 9
12. S	♥ J	6	-	-

Made 2 — NS -120

**Board 1361**  
 West Deals  
 Both Vul

♠ K 6 2		♠ Q J 10 5 4
♥ A J 6		♥ Q 10 8 4 2
♦ A J 10 8		♦ 4
♣ J 9 8		♣ 6 2
♠ 9 3	<div style="display: inline-block; background-color: green; color: white; padding: 5px; border: 1px solid black;">           N            W     E            S         </div>	♠ A 8 7
♥ K 7		♥ 9 5 3
♦ K 6 2		♦ Q 9 7 5 3
♣ A K 10 7 4 3		♣ Q 5

NS 3N; W 2♠; NS 3♦; E 1♠; EW 1♥; W 1♣; Par +500: W 4♠×-2

West	North	East	South
<i>nathan2008</i>	<i>BridgeGoth</i>	<i>wellmax</i>	<i>jec</i>
1 ♣	Dbl	1 ♥	2 ♦
3 ♣	Pass	Pass	Pass

3 ♣ by West

<i>Trick</i>	<i>Lead</i>	<i>2nd</i>	<i>3rd</i>	<i>4th</i>
1. N	♦ <u>A</u>	4	3	2
2. N	♣ 8	2	Q	<u>A</u>
3. W	♦ 6	8	<u>♣ 6</u>	5
4. E	♥ 2	3	<u>K</u>	<u>A</u>
5. N	♠ 2	4	<u>A</u>	9
6. S	♠ 8	3	<u>K</u>	5
7. N	♦ J	♥ 4	9	<u>K</u>
8. W	<u>♣ K</u>	9	♥ 8	5
9. W	♣ 7	<u>J</u>	♠ 10	♠ 7

Down 1 — NS +100

**Board 1369**

West Deals  
N-S Vul

♠ J 7 6	♠ K Q 8 4 2	♠ 10 9 5
♥ A 8	♥ Q J 3	♥ K 10 9 7 6 5
♦ A J 5 4	♦ Q 2	♦ 3
♣ A 7 5 4	♣ 10 9 2	♣ K 8 3

N	
W	E
S	

♠ A 3
♥ 4 2
♦ K 10 9 8 7 6
♣ Q J 6

EW 2♥; NS 1♦; EW 1♣; Par -110

West	North	East	South
<i>nathan2008</i>	<i>BridgeGoth</i>	<i>wellmax</i>	<i>jec</i>
1 NT	Pass	4♦ <sup>1</sup>	Dbl
4♥	Pass	Pass	Pass

1. to h

4♥ by West

<i>Trick</i>	<i>Lead</i>	<i>2nd</i>	<i>3rd</i>	<i>4th</i>
1. N	♦ Q	3	10	<u>A</u>
2. W	♥ <u>A</u>	3	5	2
3. W	♥ 8	J	<u>K</u>	4
4. E	♣ 8	<u>Q</u>	4	2
5. S	♠ <u>A</u>	6	8	5
6. S	♠ 3	J	<u>Q</u>	9
7. N	♠ <u>K</u>	10	♦ 6	7
8. N	♣ 10	-	-	-

Down 2 — NS +100

**Board 1384**  
 South Deals  
 None Vul

♠ 10 4 3 ♥ A 9 2 ♦ A K J 6 3 ♣ J 6		♠ K 6 ♥ K Q 10 4 3 ♦ 8 7 4 ♣ Q 10 8	♠ A 8 7 2 ♥ 6 5 ♦ Q 9 5 2 ♣ K 5 2
		♠ Q J 9 5 ♥ J 8 7 ♦ 10 ♣ A 9 7 4 3	

NS 3♥; EW 1N; EW 2♦; NS 2♣; EW 1♠; Par +140

West	North	East	South
<i>nathan2008</i>	<i>BridgeGoth</i>	<i>wellmax</i>	<i>jec</i>
			Pass
1♦	1♥	Dbl	2♥
Pass	Pass	3♦	3♥
Pass	Pass	Pass	

3♥ by North

Trick	Lead	2nd	3rd	4th
1. E	♥ 6	<u>7</u>	2	3
2. S	♠ 5	3	K	<u>A</u>
3. E	♣ 2	3	J	<u>Q</u>
4. N	♥ Q	5	8	<u>A</u>
5. W	♦ <u>K</u>	4	5	10
6. W	♦ A	7	2	<u>♥ J</u>
7. S	♠ <u>Q</u>	4	6	2
8. S	♠ <u>J</u>	10	♦ 8	7
9. S	♠ 9	♥ 9	<u>♥ 10</u>	8
10. N	♣ <u>10</u>	5	4	6

Made 4 — NS +170

**Board 1387**  
 East Deals  
 N-S Vul

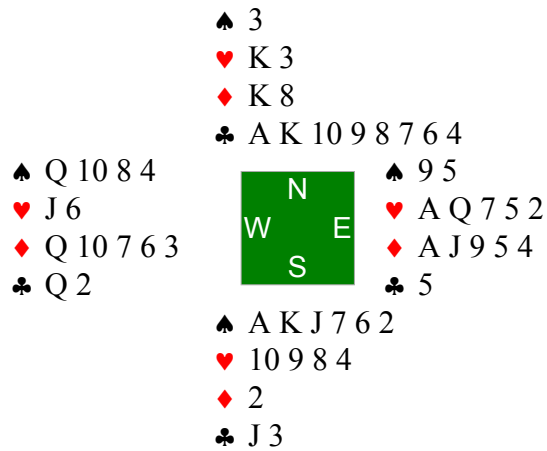

N 4N; N 5♣; S 4♣; NS 2♠; EW 3♦; EW 1♥; Par +300; EW 5♦×-2

West	North	East	South
<i>ckv</i>	<i>miamiwiz</i>	<i>george mat</i>	<i>jec</i>
		1 ♥	2 ♠
Pass	3 ♣	3 ♦	Pass
5 ♦	Dbl	Pass	Pass

Pass

5 ♦× by East

Trick	Lead	2nd	3rd	4th
1. S	♠ <u>K</u>	4	3	5
2. S	♠ <u>A</u>	8	♣ 10	9
3. S	♣ <u>J</u>	2	<u>K</u>	5
4. N	♣ <u>A</u>	♦ <u>4</u>	3	Q
5. E	♦ <u>A</u>	2	3	8
6. E	♦ 9	♠ 2	6	<u>K</u>
7. N	♥ 3	2	8	<u>J</u>

Down 2 — NS +300



**Board 1395**  
 East Deals  
 Both Vul

♠ 10 8 7 5 2	♠ K 6 3	♠ A J 9
♥ Q 8	♥ 4	♥ J 9 7 6 5
♦ K J 5	♦ A Q 9 7 6 3	♦ 10 8
♣ Q 5 3	♣ J 8 4	♣ A K 9

N	
W	E
S	

♠ Q 4
♥ A K 10 3 2
♦ 4 2
♣ 10 7 6 2

NS 2♦; NS 2♣; EW 1♠; NS 1♥; Par +90

West	North	East	South
<i>ckv</i>	<i>miamiwiz</i>	<i>george mat</i>	<i>jec</i>
		1♥	Pass
1♠	2♦	Dbl <sup>1</sup>	Pass
2♠	Pass	Pass	Pass

1. 3 sp

2♠ by West

<i>Trick</i>	<i>Lead</i>	<i>2nd</i>	<i>3rd</i>	<i>4th</i>
1. N	♥ 4	5	<u>K</u>	8
2. S	♥ <u>A</u>	Q	♦ 7	6
3. S	♦ 4	5	<u>Q</u>	8
4. N	♦ <u>A</u>	10	2	K
5. N	♦ 9	♠ 9	♠ <u>Q</u>	J
6. S	♥ 2	♠ 7	♠ <u>K</u>	7
7. N	♠ 3	<u>J</u>	4	2
8. E	♠ <u>A</u>	♣ 2	5	6
9. E	♣ 9	10	<u>Q</u>	4
10. W	♠ <u>10</u>	♦ 3	♥ 9	♥ 3

Down 1 — NS +100

**Board 1399**

East Deals  
None Vul

♠ Q 9 7 ♥ K 10 9 2 ♦ A 10 8 6 2 ♣ 2		♠ A 8 6 4 2 ♥ Q 5 ♦ K 7 ♣ A 9 5 4	♠ K 3 ♥ 8 7 6 ♦ J 9 5 3 ♣ K J 7 3
♠ J 10 5 ♥ A J 4 3 ♦ Q 4 ♣ Q 10 8 6			

NS 2♠; NS 1N; EW 2♦; NS 2♣; Par +100; EW 3♦×-1

West	North	East	South
<i>ckv</i>	<i>miamiwiz</i>	<i>george mat</i>	<i>jec</i>
		Pass	Pass
1♦	1♠	2♦	2♠
Pass	Pass	Pass	

2♠ by North

<i>Trick</i>	<i>Lead</i>	<i>2nd</i>	<i>3rd</i>	<i>4th</i>
1. E	♦ 3	4	<u>A</u>	K
2. W	♣ 2	5	<u>K</u>	6
3. E	♣ 3	8	<u>♠ 7</u>	4
4. W	♦ 8	7	5	<u>Q</u>
5. S	♠ 5	9	<u>A</u>	3
6. N	♠ 2	<u>K</u>	10	Q
7. E	♥ 7	3	<u>K</u>	5

Made 2 — NS +110

**Board 1401**  
 West Deals  
 E-W Vul

♠ 8 2	♠ A 7 5 3	♠ Q 10 9 6
♥ A K 7 2	♥ J 4	♥ Q 6
♦ J 10 5 4	♦ A Q 3	♦ K 9 8 2
♣ K J 4	♣ A Q 10 3	♣ 8 7 5

♠ K J 4
♥ 10 9 8 5 3
♦ 7 6
♣ 9 6 2

NS 3♠; N 3♥; NS 2N; S 2♥; NS 3♣; EW 1♦; Par +140

West	North	East	South
<i>ckv</i>	<i>miamiwiz</i>	<i>george mat</i>	<i>jec</i>
1 ♦	1 NT	Pass	2 ♦
Pass	2 ♥	Pass	Pass
Pass			

2 ♥ by North

<i>Trick</i>	<i>Lead</i>	<i>2nd</i>	<i>3rd</i>	<i>4th</i>
1. E	♠ 10	4	2	<u>A</u>
2. N	♥ 4	<u>Q</u>	3	2
3. E	♠ 6	<u>J</u>	8	5
4. S	♥ 5	<u>K</u>	J	6
5. W	♣ 4	3	7	<u>9</u>
6. S	♣ 2	J	<u>Q</u>	5
7. N	♣ <u>A</u>	8	6	K
8. N	♣ 10	♦ 9	♦ 6	<u>♥ 7</u>

Made 3 — NS +140

**Board 1416**  
 South Deals  
 E-W Vul

♠ Q J 10 8 5 ♥ A 8 3 ♦ K J ♣ Q 6 3		♠ A 7 6 ♥ K 5 ♦ A 10 6 5 ♣ 9 8 7 2	♠ 4 3 2 ♥ Q 6 4 2 ♦ Q 9 8 ♣ J 10 5
♠ K 9 ♥ J 10 9 7 ♦ 7 4 3 2 ♣ A K 4			

NS 3♦; NS 1N; NS 2♣; NS 1♠; NS 1♥; Par +110

West	North	East	South
<i>aggietmrop</i>	<i>ironwoman</i>	<i>zilladog</i>	<i>jec</i>

1 ♠	Pass	Pass	Pass
Pass	Pass	Pass	1 NT

1 NT by South

<i>Trick</i>	<i>Lead</i>	<i>2nd</i>	<i>3rd</i>	<i>4th</i>
1. W	♠ Q	6	2	9
2. W	♠ J	7	3	<u>K</u>
3. S	♦ 2	J	<u>A</u>	8
4. N	♦ 5	9	3	<u>K</u>
5. W	♠ 5	<u>A</u>	4	♣ 4
6. N	♦ 10	Q	4	♥ 8
7. E	♣ 5	<u>A</u>	3	2
8. S	♦ 7	♥ 3	6	♥ 2
9. S	♥ 7	<u>A</u>	5	4
10. W	♠ 10	♣ 7	♣ 10	♥ 9
11. W	♠ 8	♣ 8	♥ 6	♥ 10
12. W	♣ 6	-	-	-

Made 1 — NS +90

**Board 1435**  
 West Deals  
 N-S Vul

♠ A 3	♠ K Q 10 2	♠ J 6
♥ A 3	♥ Q J 10 7 5 4	♥ K 9 8 2
♦ A Q 10 9 8 3	♦ K 5	♦ 7 6
♣ J 9 6	♣ K	♣ 10 8 7 5 2

♠ 9 8 7 5 4
♥ 6
♦ J 4 2
♣ A Q 4 3

NS 3♠; NS 2♥; EW 1♦; EW 1♣; Par +140

West	North	East	South
<i>Dejavu35</i>	<i>smispi</i>	<i>delican</i>	<i>jec</i>
1 ♦	1 ♥	Pass	1 ♠
2 ♦	2 ♠	Pass	Pass
3 ♦	3 ♠	Pass	Pass

Pass

3 ♠ by South

<i>Trick</i>	<i>Lead</i>	<i>2nd</i>	<i>3rd</i>	<i>4th</i>
1. W	♥ <u>A</u>	4	8	6
2. W	♥ 3	<u>Q</u>	2	♦ 2
3. N	♣ <u>K</u>	2	3	6
4. N	♠ <u>Q</u>	6	4	<u>A</u>
5. W	♦ <u>A</u>	5	7	J
6. W	♣ 9	♠ <u>2</u>	5	4
7. N	♠ <u>K</u>	J	5	3

Made 4 — NS +170

**Board 1437**  
 East Deals  
 None Vul

♠ A Q 8 7 6 4 ♥ A 9 3 ♦ Q 6 ♣ 10 4		♠ J 9 5 ♥ 8 7 4 ♦ A K 9 2 ♣ A Q 8	♠ K 3 ♥ Q J 5 2 ♦ 8 7 4 3 ♣ J 7 2
		♠ 10 2 ♥ K 10 6 ♦ J 10 5 ♣ K 9 6 5 3	

EW 2♠; NS 3♦; NS 3♣; EW 1♥; Par +100; EW 3♠×-1

West	North	East	South
<i>Dejavu35</i>	<i>smispi</i>	<i>delican</i>	<i>jec</i>
		Pass	Pass
1 ♠	Dbl	Pass	2 ♣
Pass	Pass	2 ♠	Dbl
Pass	3 ♣	Pass	Pass
Pass			

3 ♣ by South

Trick	Lead	2nd	3rd	4th
1. W	<u>♠ A</u>	5	3	2
2. W	<u>♠ 4</u>	9	<u>K</u>	10
3. E	<u>♥ 2</u>	10	<u>A</u>	4
4. W	<u>♠ Q</u>	J	<u>♥ 5</u>	<u>♣ 3</u>
5. S	<u>♣ 5</u>	4	<u>Q</u>	2
6. N	<u>♣ A</u>	7	6	10
7. N	<u>♣ 8</u>	J	<u>K</u>	<u>♠ 6</u>
8. S	<u>♦ J</u>	6	2	4
9. S	<u>♦ 10</u>	Q	<u>K</u>	3
10. N	<u>♦ A</u>	7	5	<u>♠ 7</u>
11. N	<u>♦ 9</u>	8	<u>♥ 6</u>	<u>♥ 3</u>
12. N	<u>♥ 7</u>	J	<u>K</u>	9
13. S	<u>♣ 9</u>	<u>♠ 8</u>	<u>♥ 8</u>	<u>♥ Q</u>

Made 4 — NS +130

**Board 1440**  
 North Deals  
 None Vul

♠ K 8	♠ —	♠ Q J 4
♥ 7 6 2	♥ K Q 4	♥ 9 8 3
♦ A K J 10 4	♦ 8 7 3 2	♦ Q 6 5
♣ K 6 4	♣ 10 9 8 7 3 2	♣ A Q J 5

N	
W	E
S	

♠ A 10 9 7 6 5 3 2
♥ A J 10 5
♦ 9
♣ —

NS 4♠; EW 2N; NS 2♥; EW 1♦; EW 1♣; Par +300; EW 4N×-2

West	North	East	South
<i>Dejavu35</i>	<i>smispi</i>	<i>delican</i>	<i>jec</i>
	Pass	1 ♣	1 ♠
Dbl	Pass	1 NT	4 ♠
Dbl	Pass	Pass	Pass

4 ♠× by South

<i>Trick</i>	<i>Lead</i>	<i>2nd</i>	<i>3rd</i>	<i>4th</i>
1. W	♦ A	2	5	9
2. W	♦ K	3	6	♠ 2
3. S	♠ A	8	♣ 2	4
4. S	♠ 10	♠ K	♣ 3	J
5. W	♦ J	7	Q	♠ 3

Made 4 — NS +590

**Board 1443**  
 West Deals  
 Both Vul

♠ 10 4 ♥ 6 5 3 ♦ 8 7 6 5 3 ♣ A Q 5	♠ A J 7 5 ♥ 9 8 ♦ Q 10 4 ♣ J 10 7 3		♠ K Q 8 ♥ A J ♦ A J 9 ♣ K 9 8 6 2
♠ 9 6 3 2 ♥ K Q 10 7 4 2 ♦ K 2 ♣ 4			

NS 2♠; NS 2♥; EW 3♦; EW 3♣; EW 1N; Par -110

West	North	East	South
<i>Dejavu35</i>	<i>smispi</i>	<i>delican</i>	<i>jec</i>
Pass	Pass	1 ♣	2 ♥
Pass	Pass	Dbl	Pass
3 ♦	Pass	3 NT	Pass
Pass	Pass		

3 NT by East

<i>Trick</i>	<i>Lead</i>	<i>2nd</i>	<i>3rd</i>	<i>4th</i>
1. S	♥ Q	3	9	J
2. S	♥ 2	5	8	<u>A</u>
3. E	♣ 2	4	<u>Q</u>	7
4. W	♠ 4	<u>A</u>	8	2
5. N	♦ 4	<u>A</u>	2	3
6. E	♣ 9	♥ 4	<u>A</u>	3
7. W	♣ 5	10	<u>K</u>	♠ 3
8. E	♠ K	6	10	5
9. E	♣ 6	♠ 9	♥ 6	<u>J</u>
10. N	♦ 10	J	-	-

Down 3 — NS +300



**Board 1444**  
 North Deals  
 None Vul

♠ A 10 7 5 4 ♥ K J 10 ♦ 6 ♣ 8 7 6 2	♠ K J 6 2 ♥ A 5 3 ♦ Q J 8 4 ♣ 9 3		♠ 9 8 ♥ Q 8 6 2 ♦ K 10 ♣ A Q J 10 5
♠ Q 3 ♥ 9 7 4 ♦ A 9 7 5 3 2 ♣ K 4			

NS 2N; NS 3♦; EW 3♣; EW 1♥; Par +100; EW 4♣×-1

West	North	East	South
<i>faramarz</i>	<i>smispi</i>	<i>edowell</i>	<i>jec</i>
	Pass	1 ♣	2 ♦
Dbl	Rdbl	2 ♥	Pass
2 ♠	3 ♦	Pass	Pass
4 ♣	Pass	Pass	Pass

4 ♣ by East

<i>Trick</i>	<i>Lead</i>	<i>2nd</i>	<i>3rd</i>	<i>4th</i>
1. S	<u>♦ A</u>	6	Q	10
2. S	♦ 3	<u>♣ 2</u>	J	K
3. W	♣ 6	9	Q	<u>K</u>
4. S	♣ 4	7	3	-

Down 1 — NS +50

**Board 1447**  
 West Deals  
 Both Vul

♠ 7 3	♠ K J 9 4	♠ Q 8 6
♥ K Q J 7	♥ 10 6 4	♥ A 2
♦ Q	♦ A K J 10	♦ 8 7 6 4
♣ K Q 10 8 6 4	♣ J 5	♣ A 9 3 2

♠ A 10 5 2
♥ 9 8 5 3
♦ 9 5 3 2
♣ 7

NS 3♠; EW 4♣; NS 2♦; Par -130

West	North	East	South
<i>faramarz</i>	<i>smispi</i>	<i>edowell</i>	<i>jec</i>
1 ♣	Dbl	Rdbl	Pass
Pass	1 ♦	2 ♣	3 ♦
3 ♥	Pass	5 ♣	Pass
Pass	Pass		

5 ♣ by West

<i>Trick</i>	<i>Lead</i>	<i>2nd</i>	<i>3rd</i>	<i>4th</i>
1. N	<u>♦ K</u>	4	9	Q
2. N	<u>♠ K</u>	6	5	7
3. N	<u>♠ J</u>	8	2	3

Down 1 — NS +100

**Board 1453**

East Deals  
Both Vul

♠ A 7		♠ 10 9 8 6 4
♥ K J 8 5 4		♥ 9
♦ 5		♦ K J 8 2
♣ A Q J 7 6		♣ 9 3 2
♠ Q 5 3	<div style="display: inline-block; background-color: green; color: white; padding: 5px; border: 1px solid black;">             N W     E S           </div>	♠ K J 2
♥ 3 2		♥ A Q 10 7 6
♦ A Q 10 9 7 3		♦ 6 4
♣ K 4		♣ 10 8 5

NS 6♥; NS 6♣; NS 1N; EW 1♦; Par +1430

West	North	East	South
<i>faramarz</i>	<i>smispi</i>	<i>edowell</i>	<i>jec</i>
		Pass	Pass
1♦	2NT <sup>1</sup>	Pass	4♥
Pass	Pass	Pass	

1. H+C

4♥ by South

<i>Trick</i>	<i>Lead</i>	<i>2nd</i>	<i>3rd</i>	<i>4th</i>
1. W	♠ 5	7	8	<u>J</u>
2. S	♥ 6	2	<u>J</u>	9
3. N	♥ <u>K</u>	♦ 8	7	3
4. N	♠ <u>A</u>	4	2	3
5. N	♥ 4	♠ 10	<u>A</u>	♦ 3
6. S	♠ <u>K</u>	Q	♦ 5	6
7. S	♣ 10	K	-	-

Made 7 — NS +710

**Board 1455**  
 West Deals  
 N-S Vul

♠ K Q 8 2	<div style="display: inline-block; background-color: green; color: white; padding: 10px; border: 1px solid black;">           N            W     E            S         </div>	♠ 7
♥ A Q		♥ J 8 2
♦ J 10 5 2		♦ A Q 8 7 4
♣ 4 3 2		♣ A 9 6 5
♠ J 4 3		♥ K 10 6 5 3
	♦ 6	
	♣ J 10 8 7	
	♠ A 10 9 6 5	
	♥ 9 7 4	
	♦ K 9 3	
	♣ K Q	

EW 3♦; EW 1N; NS 1♠; NS 1♥; EW 1♣; Par -110

West	North	East	South
<i>faramarz</i>	<i>smispi</i>	<i>edowell</i>	<i>jec</i>
1♦	Pass	2♦	2♠
Pass	Pass	Dbl	Pass
Pass	Pass		

2♠× by South

<i>Trick</i>	<i>Lead</i>	<i>2nd</i>	<i>3rd</i>	<i>4th</i>
1. W	♦ J	6	<u>A</u>	3
2. E	♠ 7	5	<u>Q</u>	3
3. W	♥ <u>A</u>	3	8	9
4. W	♥ <u>Q</u>	<u>K</u>	2	4
5. N	♣ 7	6	<u>K</u>	4
6. S	♦ 9	10	<u>♠ 4</u>	4
7. N	♠ J	♦ 7	6	<u>K</u>
8. W	♣ 3	8	<u>A</u>	Q
9. E	♥ <u>J</u>	7	♣ 2	5
10. E	♣ 5	♦ K	<u>♠ 2</u>	10
11. W	♦ 2	-	-	-

Down 2 — NS -500

**Board 1457**  
 East Deals  
 N-S Vul

♠ Q 5 4	♠ 10 7 3 2	♠ J
♥ A 4 2	♥ 7 6	♥ K Q J 10 9 5 3
♦ 9 4 3 2	♦ A K J 6	♦ 8 7
♣ A 6 3	♣ 9 8 4	♣ Q 7 5

N	
W	E
S	

♠ A K 9 8 6
♥ 8
♦ Q 10 5
♣ K J 10 2

NS 4♠; EW 2♥; NS 3♦; NS 3♣; EW 1N; Par +500; EW 4N×-3;  
 EW 5♥×-3

West	North	East	South
<i>lengy</i>	<i>llorenzo</i>	<i>bareket</i>	<i>jec</i>
		3♥	Dbl
Pass	4♥	Pass	4♠
Pass	Pass	Pass	

4♠ by South

Trick	Lead	2nd	3rd	4th
1. W	♥ <u>A</u>	6	K	8
2. W	♥ 2	7	Q	♠ <u>6</u>
3. S	♠ <u>A</u>	4	2	J
4. S	♦ 5	2	<u>K</u>	8
5. N	♣ 9	5	2	<u>A</u>
6. W	♦ 3	<u>J</u>	7	10
7. N	♣ 8	Q	<u>K</u>	6
8. S	♠ <u>K</u>	5	3	♥ 3

Made 4 — NS +620

**Board 1463**  
 West Deals  
 None Vul

♠ A Q 3	<div style="display: inline-block; background-color: green; color: white; padding: 10px; border: 1px solid black;">           N W     E S         </div>	♠ 7 6
♥ J 10 7 3		♥ Q 8 2
♦ 7 3		♦ A Q J 9 6 4
♣ J 10 4 3		♣ 6 2
		♠ K J 9 8 5 4
		♥ 5
		♦ K 2
		♣ A K 9 8

NS 4♠; NS 3♣; EW 1N; NS 1♥; EW 1♦; Par +420

West	North	East	South
<i>lengy</i>	<i>llorenzo</i>	<i>bareket</i>	<i>jec</i>
Pass	Pass	3 ♦	3 ♠
Pass	4 ♠	Pass	Pass
Pass			

4 ♠ by South

<i>Trick</i>	<i>Lead</i>	<i>2nd</i>	<i>3rd</i>	<i>4th</i>
1. W	♦ 7	5	<u>A</u>	2
2. E	♦ Q	<u>K</u>	3	8
3. S	♥ 5	3	<u>K</u>	2
4. N	♠ 10	6	4	<u>Q</u>
5. W	♥ 7	4	Q	<u>♠ 5</u>
6. S	♠ K	<u>A</u>	2	7

Made 4 — NS +420

**Board 1465**  
 East Deals  
 Both Vul

♠ K 5 4 2 ♥ Q 10 8 2 ♦ 6 4 ♣ 9 8 6		♠ Q 9 8 6 ♥ 9 5 ♦ J 8 2 ♣ A J 5 2	♠ — ♥ K 6 3 ♦ A K Q 10 9 7 3 ♣ K 10 7
		♠ A J 10 7 3 ♥ A J 7 4 ♦ 5 ♣ Q 4 3	

NS 3♠; EW 4♦; EW 2N; EW 2♥; NS 1♣; Par -130

West	North	East	South
<i>lengy</i>	<i>llorenzo</i>	<i>bareket</i>	<i>jec</i>
		1♦	1♠
Pass	3♠	Dbl	Pass
Pass	Pass		

3♠× by South

<i>Trick</i>	<i>Lead</i>	<i>2nd</i>	<i>3rd</i>	<i>4th</i>
1. W	<u>♦ 6</u>	2	3	5
2. W	♣ 9	2	<u>K</u>	4
3. E	♦ A	<u>♠ 3</u>	4	8
4. S	<u>♠ J</u>	2	6	♦ 10
5. S	<u>♥ A</u>	2	5	3
6. S	♥ 4	8	9	<u>K</u>
7. E	♦ K	<u>♠ 10</u>	♣ 8	J
8. S	♥ 7	10	<u>♠ 8</u>	6
9. N	♣ 5	10	<u>Q</u>	6
10. S	♥ J	Q	<u>♠ 9</u>	♦ 7
11. N	♣ A	7	3	<u>♠ 4</u>
12. W	♠ 5	<u>Q</u>	♦ 9	7
13. N	♣ J	♦ Q	<u>♠ A</u>	♠ K

Made 3 — NS +730

**Board 1467**

West Deals  
N-S Vul

♠ 9	♠ A J 10	♠ K 8 6
♥ A J 10 3	♥ 8 7 6	♥ 9 5 4 2
♦ A Q 9 8	♦ J 2	♦ K 10 7 5
♣ Q J 10 2	♣ 9 7 6 4 3	♣ 8 5

N	
W	E
S	

♠ Q 7 5 4 3 2
♥ K Q
♦ 6 4 3
♣ A K

EW 3♥; NS 2♠; EW 3♦; EW 1♣; Par -140

West	North	East	South
<i>lengy</i>	<i>llorenzo</i>	<i>bareket</i>	<i>jec</i>
1 ♣	Pass	1 ♦ <sup>1</sup>	1 ♠
3 ♥	Pass	Pass	Pass

1. h

3 ♥ by West

<i>Trick</i>	<i>Lead</i>	<i>2nd</i>	<i>3rd</i>	<i>4th</i>
1. N	♠ A	6	2	9
2. N	♣ 6	5	<u>K</u>	2
3. S	♠ Q	♦ 9	10	<u>K</u>
4. E	♥ 2	Q	<u>A</u>	6
5. W	♥ 10	7	4	<u>K</u>
6. S	♣ A	10	3	8
7. S	♠ 3	♥ J	J	8
8. W	♥ 3	8	-	-

Made 3 — NS -140



**Board 1479**  
 West Deals  
 None Vul

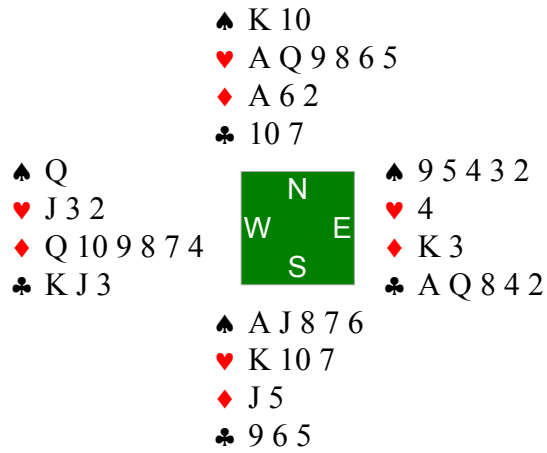

NS 4♥; NS 2N; NS 2♠; EW 2♦; EW 2♣; Par +420

West	North	East	South
<i>lengy</i>	<i>llorenzo</i>	<i>bareket</i>	<i>jec</i>
3 ♦	3 ♥	4 ♣	4 ♥
Pass	Pass	Pass	

4 ♥ by North

<i>Trick</i>	<i>Lead</i>	<i>2nd</i>	<i>3rd</i>	<i>4th</i>
1. E	♦ 3	5	7	<u>A</u>
2. N	♥ <u>A</u>	4	7	2
3. N	♠ <u>K</u>	2	6	Q
4. N	♥ <u>Q</u>	♣ 4	10	3
5. N	♥ 5	♣ 2	<u>K</u>	J
6. S	♠ <u>A</u>	♦ 4	10	3
7. S	♠ <u>J</u>	♦ 8	♦ 2	4

Made 4 — NS +420

**Board 1484**  
 North Deals  
 None Vul

♠ 10 5 4 2 ♥ A K J 10 8 ♦ K 9 ♣ 7 3		♠ K 7 ♥ Q ♦ J 10 8 7 6 4 3 ♣ Q 6 2	♠ A 8 6 ♥ 7 4 3 2 ♦ A Q 5 2 ♣ J 8
		♠ Q J 9 3 ♥ 9 6 5 ♦ — ♣ A K 10 9 5 4	

NS 4♣; E 2♥; EW 1N; NS 2♦; W 1♥; Par +130

West	North	East	South
<i>phil</i>	<i>BridgeGoth</i>	<i>leroumain</i>	<i>jec</i>
	Pass	1 ♦	2 ♣
Dbl	3 ♣	Pass	4 ♣
Dbl	Pass	4 ♥	Pass
Pass	Pass		

4 ♥ by East

Trick	Lead	2nd	3rd	4th
1. S	♣ 4	3	<u>Q</u>	8
2. N	♦ 7	2	<u>♥ 5</u>	9
3. S	♣ <u>A</u>	7	2	J
4. S	♠ Q	2	7	<u>A</u>
5. E	♥ 2	6	<u>K</u>	Q
6. W	♥ <u>A</u>	♦ 3	3	9
7. W	♦ <u>K</u>	4	5	♣ 5
8. W	♠ 4	<u>K</u>	6	3
9. N	♦ J	-	-	-

Down 1 — NS +50

**Board 1489**  
 East Deals  
 E-W Vul

♠ K J 9 6 2	<div style="display: inline-block; background-color: green; color: white; padding: 10px; border: 1px solid black;">           N W     E S         </div>	♠ A Q 8 4 3
♥ A Q 7 6		♥ 5
♦ A J 10		♦ 8 5 2
♣ 4		♣ Q 10 3 2

♠ 10
♥ 9 4 2
♦ Q 9 6 4
♣ A K J 9 7

EW 5♠; NS 2♥; EW 1N; S 2♣; N 1♣; Par -650

West	North	East	South
<i>phil</i>	<i>BridgeGoth</i>	<i>leroumain</i>	<i>jec</i>
		Pass	Pass
1 ♠	Pass	4 ♠	4 NT
Dbl	Pass	Pass	5 ♣
Pass	Pass	Dbl	Pass
Pass	Pass		

5 ♣× by South

Trick	Lead	2nd	3rd	4th
1. W	♣ 4	5	2	<u>7</u>
2. S	<u>♣ A</u>	♠ 6	6	3
3. S	♥ 2	<u>A</u>	3	5
4. W	♠ 2	5	<u>A</u>	10
5. E	♠ 3	<u>♣ 9</u>	K	7
6. S	♥ 4	6	10	<u>♣ 10</u>
7. E	♦ 2	4	10	<u>K</u>
8. N	♣ 8	Q	<u>K</u>	♠ 9
9. S	♥ 9	7	<u>J</u>	♠ 4
10. N	<u>♥ K</u>	♠ 8	♦ 6	Q
11. N	<u>♥ 8</u>	♠ Q	♦ 9	♠ J
12. N	♦ 3	5	Q	<u>A</u>
13. W	♦ J	7	8	<u>♣ J</u>

Down 2 — NS -300

**Board 1495**  
 West Deals  
 N-S Vul

♠ K 10 3 ♥ K Q 3 ♦ J 10 4 ♣ Q 10 9 3		♠ 6 5 4 ♥ 10 8 5 4 2 ♦ A 6 ♣ 8 7 6	♠ 8 7 2 ♥ J 7 ♦ K Q 9 7 5 2 ♣ J 5
♠ A Q J 9 ♥ A 9 6 ♦ 8 3 ♣ A K 4 2			

NS 3♥; NS 1N; NS 1♠; EW 1♦; NS 1♣; Par +140

West	North	East	South
<i>phil</i>	<i>BridgeGoth</i>	<i>leroumain</i>	<i>jec</i>
Pass	Pass	3♦	Dbl
Pass	3♥	Pass	Pass
Pass			

3♥ by North

<i>Trick</i>	<i>Lead</i>	<i>2nd</i>	<i>3rd</i>	<i>4th</i>
1. E	♦ K	3	J	<u>A</u>
2. N	♥ 2	7	9	<u>Q</u>
3. W	♦ 10	6	<u>Q</u>	8
4. E	♦ 9	<u>♥ 6</u>	4	♣ 6
5. S	<u>♥ A</u>	3	4	J
6. S	<u>♣ A</u>	3	7	5
7. S	<u>♣ K</u>	9	8	J
8. S	♣ 2	Q	<u>♥ 5</u>	♦ 2
9. N	♠ 4	2	J	<u>K</u>
10. W	♥ K	-	-	-
Made 3 — NS +140				

**Board 1503**  
West Deals  
Both Vul

♠ 10	♠ 4	♠ J 9 8 7 5
♥ A 8 3 2	♥ 6 5 4	♥ K Q 10 7
♦ A Q 6 2	♦ J 10 9 4 3	♦ 8 5
♣ A K 6 3	♣ Q J 5 2	♣ 10 8

♠ A K Q 6 3 2	<table style="border: 2px solid green; width: 40px; height: 40px; margin: auto; text-align: center; color: white; font-weight: bold; font-size: 1.2em;"> <tr><td></td><td>N</td><td></td></tr> <tr><td>W</td><td></td><td>E</td></tr> <tr><td></td><td>S</td><td></td></tr> </table>		N		W		E		S		♠ J 9 8 7 5
	N										
W		E									
	S										
♥ J 9		♥ K Q 10 7									
♦ K 7		♦ 8 5									
♣ 9 7 4		♣ 10 8									

EW 5♥; EW 3N; EW 2♠; EW 2♦; EW 2♣; Par -650

West	North	East	South
<i>phil</i>	<i>BridgeGoth</i>	<i>leroumain</i>	<i>jec</i>
1 ♦	Pass	1 ♠	2 ♠
Dbl	Pass	Pass	Pass

2 ♠× by South

<i>Trick</i>	<i>Lead</i>	<i>2nd</i>	<i>3rd</i>	<i>4th</i>
1. W	<u>♣ A</u>	2	10	4
2. W	<u>♣ K</u>	5	8	7
3. W	♣ 3	J	<u>♠ 5</u>	9
4. E	♦ 8	K	<u>A</u>	3
5. W	<u>♦ Q</u>	4	5	7
6. W	<u>♥ A</u>	4	10	9
7. W	♥ 2	5	<u>Q</u>	J
8. E	♥ K	<u>♠ 2</u>	3	6
9. S	<u>♠ A</u>	10	4	7
10. S	<u>♠ K</u>	♦ 2	♦ 9	8
11. S	<u>♠ Q</u>	♦ 6	♦ 10	9
12. S	♠ 3	♣ 6	♦ J	<u>J</u>
13. E	♥ 7	<u>♠ 6</u>	8	♣ Q

Down 3 — NS -800

**Board 1507**  
 West Deals  
 None Vul

♠ A Q 8 4 ♥ K 6 4 ♦ K 7 3 ♣ J 9 5		♠ K 6 5 ♥ 9 5 ♦ A Q J 6 2 ♣ K 6 3	♠ J 10 9 7 3 ♥ A Q J 8 7 3 ♦ 5 4 ♣ —
♠ 2 ♥ 10 2 ♦ 10 9 8 ♣ A Q 10 8 7 4 2			

W 5♠; E 4♠; EW 4♥; NS 4♣; NS 2♦; Par -300; NS 6♣×-2

West	North	East	South
<i>shurik</i>	<i>BridgeGoth</i>	<i>leroumain</i>	<i>jec</i>
1 ♣	1 ♦	1 ♥	Pass
1 NT	Pass	2 ♠	Pass
3 ♠	Pass	4 ♠	Pass
Pass	Pass		

4 ♠ by East

<i>Trick</i>	<i>Lead</i>	<i>2nd</i>	<i>3rd</i>	<i>4th</i>
1. S	♦ 8	K	<u>A</u>	4
2. N	<u>♦ Q</u>	5	9	3
3. N	♣ 3	<u>♠ 3</u>	7	5
4. E	♠ J	2	<u>A</u>	5
5. W	♠ 4	<u>K</u>	7	♣ 2
6. N	♠ 6	-	-	-

Made 4 — NS -420

**Board 1509**  
 East Deals  
 Both Vul

♠ 8 ♥ A Q J 5 4 ♦ 10 4 ♣ K J 8 5 3	♠ A K Q J 10 4 ♥ 9 7 3 ♦ A ♣ A 6 4		♠ 9 7 3 ♥ K 8 6 ♦ J 8 7 6 ♣ 9 7 2
	♠ 6 5 2 ♥ 10 2 ♦ K Q 9 5 3 2 ♣ Q 10		

NS 4♠; EW 3♥; NS 2N; NS 3♦; EW 3♣; Par +500; EW 5♣×-2;  
 EW 5♥×-2

West	North	East	South
<i>shurik</i>	<i>BridgeGoth</i>	<i>leroumain</i>	<i>jec</i>
		Pass	Pass
1 ♥	4 ♠	Pass	Pass

Pass

4 ♠ by North

Trick	Lead	2nd	3rd	4th
1. E	♥ 6	2	<u>J</u>	3
2. W	♥ 4	7	<u>K</u>	10
3. E	♣ 2	10	J	<u>A</u>
4. N	♣ 4	7	Q	<u>K</u>
5. W	♠ 8	<u>A</u>	3	2
6. N	♦ <u>A</u>	7	2	4
7. N	♠ <u>K</u>	7	5	♣ 3
8. N	♣ 6	9	<u>♠ 6</u>	5
9. S	♦ <u>K</u>	10	♥ 9	6
10. S	♦ 3	♥ 5	<u>♠ Q</u>	8

Made 4 — NS +620

**Board 1515**  
 West Deals  
 Both Vul

♠ K J 8 5 4	♠ Q	♠ A 7 3 2
♥ A Q 2	♥ K 10 7 3	♥ J 9 4
♦ 3	♦ A K Q 7 5 2	♦ 9 8 6
♣ Q 10 8 2	♣ 9 3	♣ A J 6

♠ 10 9 6
♥ 8 6 5
♦ J 10 4
♣ K 7 5 4

EW 4♠; NS 3♦; EW 1N; EW 2♣; W 1♥; Par -500: NS 5♦×-2

West	North	East	South
<i>pdc</i>	<i>ollina</i>	<i>smispi</i>	<i>jec</i>
1 ♠	2 ♦	3 ♦	Pass
3 ♠	Pass	Pass	Pass

3 ♠ by West

<i>Trick</i>	<i>Lead</i>	<i>2nd</i>	<i>3rd</i>	<i>4th</i>
1. N	<u>♦ A</u>	6	4	3
2. N	♦ K	8	10	<u>♠ 4</u>
3. W	♠ 5	Q	<u>A</u>	6
4. E	♠ 2	9	<u>K</u>	♦ 7
5. W	<u>♠ J</u>	♦ 2	3	10
6. W	♣ 2	3	J	<u>K</u>
7. S	♥ 8	2	<u>K</u>	4
8. N	♦ Q	-	-	-

Made 4 — NS -170



**Board 1517**  
 East Deals  
 E-W Vul

♠ Q J ♥ A 5 3 ♦ J 9 7 4 ♣ 8 7 5 2		♠ 8 2 ♥ J 9 ♦ 10 6 5 3 2 ♣ Q J 10 6	♠ A 9 5 4 ♥ Q 8 ♦ A K Q 8 ♣ A K 9
♠ K 10 7 6 3 ♥ K 10 7 6 4 2 ♦ — ♣ 4 3			

E 4N; W 3N; E 3♠; E 4♦; E 4♣; W 2♠; W 3♦; W 3♣; NS 1♥;  
 Par -630

West	North	East	South
<i>pdc</i>	<i>ollina</i>	<i>smispi</i>	<i>jec</i>
		2 NT	3 ♣
3 NT	Pass	Pass	Pass

3 NT by East

<i>Trick</i>	<i>Lead</i>	<i>2nd</i>	<i>3rd</i>	<i>4th</i>
1. S	♥ 6	3	J	Q
2. E	♠ 4	<u>K</u>	J	2
3. S	♥ K	<u>A</u>	9	8
4. W	♦ 4	2	<u>A</u>	♠ 6
5. E	<u>♦ K</u>	♥ 2	7	3
6. E	<u>♦ Q</u>	♥ 4	9	5
7. E	<u>♣ A</u>	3	2	6
8. E	♠ 5	7	<u>Q</u>	8
9. W	♣ 5	10	<u>K</u>	4
10. E	♠ A	3	♥ 5	♦ 6

Made 4 — NS -630

**Board 1523**  
 West Deals  
 N-S Vul

♠ A 10 6 3		♠ J 9
♥ J		♥ K Q 8 6 4 3
♦ A Q 10 6 3		♦ 9 5
♣ Q 8 6		♣ 10 4 3
		♠ K Q 5
		♥ 5
		♦ K J 7 4 2
		♣ A K 7 2

S 2N; S 2♠; N 1N; N 1♠; EW 1♥; S 1♦; NS 1♣; Par +120

West	North	East	South
<i>pd</i>	<i>ollina</i>	<i>smispi</i>	<i>jec</i>
1♦	Pass	1♥	Dbl
1♠	Pass	2♥	Pass
Pass	Pass		

2♥ by East

<i>Trick</i>	<i>Lead</i>	<i>2nd</i>	<i>3rd</i>	<i>4th</i>
1. S	♦ 7	<u>Q</u>	8	5
2. W	♥ J	2	3	5
3. W	♦ A	♥ 7	9	4
4. N	♠ 7	9	Q	<u>A</u>
5. W	♦ 3	♣ 5	♥ 4	2
6. E	♠ J	<u>K</u>	3	2
7. S	♦ K	6	♣ 9	♥ 6
8. E	♣ 3	<u>K</u>	6	J
9. S	♣ A	8	♠ 4	4
10. S	♦ J	10	♠ 8	♥ 8
11. E	♥ K	♠ 5	♠ 6	<u>A</u>
12. N	♥ 9	-	-	-

Down 1 — NS +50

**Board 1540**  
 North Deals  
 E-W Vul

♠ 6 5 ♥ A K Q 8 3 2 ♦ J 5 2 ♣ A 2	♠ Q 8 4 2 ♥ 10 4 ♦ 10 ♣ K J 10 9 7 3	<div style="border: 1px solid black; background-color: #006400; color: white; padding: 5px; width: 40px; margin: 0 auto;">           N            W     E            S         </div>	♠ K J 10 9 7 3 ♥ J 7 5 ♦ 4 ♣ 8 6 5
♠ A ♥ 9 6 ♦ A K Q 9 8 7 6 3 ♣ Q 4			

EW 4♥; NS 4♦; EW 2♠; NS 2♣; Par -100: NS 5♦×-1

West	North	East	South
<i>osvaill83</i>	<i>ronpa</i>	<i>jansen11</i>	<i>jec</i>
	Pass	2♦ <sup>1</sup>	3NT
Pass	Pass	Pass	

1. weak one major, less than 8hcp

3 NT by South

<i>Trick</i>	<i>Lead</i>	<i>2nd</i>	<i>3rd</i>	<i>4th</i>
1. W	♥K	4	5	6
2. W	♥A	10	J	9
3. W	♥Q	♣3	7	♣4
4. W	♥2	♣7	♣8	♣Q
5. W	♥3	♠2	♠3	♦3
6. W	♥8	♦10	♣6	♦6
7. W	♠6	4	7	A
8. S	♦A	2	♣9	4
9. S	♦K	5	♣10	♣5
10. S	♦Q	J	♣J	♠9
11. S	♦9	♣2	♣K	♠10

Down 2 — NS -100

**Board 1542**  
 South Deals  
 None Vul

♠ A 4 3 2 ♥ K 8 5 ♦ A 9 4 3 ♣ K 5		♠ Q 10 5 ♥ 9 7 4 ♦ — ♣ A J 9 8 7 6 4	♠ K J 6 ♥ Q 10 3 2 ♦ Q J 10 8 2 ♣ Q
		♠ 9 8 7 ♥ A J 6 ♦ K 7 6 5 ♣ 10 3 2	

EW 4N; W 4♠; W 4♥; EW 5♦; E 3♠; E 3♥; NS 1♣; Par -430

West	North	East	South
<i>osvaill83</i>	<i>ronpa</i>	<i>jansen11</i>	<i>jec</i>
			Pass
1 ♦	Pass	1 ♥	Pass
1 ♠	3 ♣	3 ♦	Pass
Pass	Pass		

3 ♦ by West

Trick	Lead	2nd	3rd	4th
1. N	♥ 4	2	J	<u>K</u>
2. W	♦ <u>A</u>	♣ 7	2	5
3. W	♦ 3	♣ 4	J	<u>K</u>
4. S	♣ 2	5	<u>A</u>	Q
5. N	♣ 6	♠ 6	10	<u>K</u>
6. W	♥ 5	7	10	<u>A</u>
7. S	♣ 3	♥ 8	8	<u>♦ 8</u>
8. E	♥ 3	6	-	-

Made 4 — NS -130

**Board 1543**  
 West Deals  
 N-S Vul

♠ 6 3	♠ A J 8 2	♠ K 9 7 5 4
♥ A J 3	♥ 4 2	♥ 8 7 5
♦ A K 9 3	♦ J 5 4	♦ 8 6
♣ A Q 10 4	♣ 9 8 3 2	♣ K J 5

	N	
W		E
	S	

♠ Q 10
♥ K Q 10 9 6
♦ Q 10 7 2
♣ 7 6

EW 3N; EW 3♠; EW 3♥; EW 4♣; EW 3♦; Par -400

West	North	East	South
<i>osvaill83</i>	<i>ronpa</i>	<i>jansen11</i>	<i>jec</i>
1 ♣	Pass	1 ♥ <sup>1</sup>	Pass
2 NT	Pass	3 ♥ <sup>2</sup>	Dbl
3 NT	Pass	Pass	Pass

1. ♠
2. 5+ ♠

3 NT by West

<i>Trick</i>	<i>Lead</i>	<i>2nd</i>	<i>3rd</i>	<i>4th</i>
1. N	♥ 4	5	<u>Q</u>	3
2. S	♥ 10	<u>J</u>	2	7
3. W	♠ 6	2	9	<u>10</u>
4. S	♥ K	<u>A</u>	♦ 4	8
5. W	♠ 3	8	<u>K</u>	Q
6. E	<u>♣ K</u>	6	4	2
7. E	<u>♣ J</u>	7	10	3
8. E	♣ 5	♦ 2	<u>Q</u>	8
9. W	♣ A	9	♦ 6	-

Made 3 — NS -400

**Board 1544**  
 North Deals  
 Both Vul

	♠ K 8 6 2		
	♥ Q 5 3		
	♦ 7 6 3		
	♣ A 6 5		
♠ Q 9 7 5 4 3 ♥ 10 6 ♦ A J ♣ K J 7	<div style="background-color: green; color: white; padding: 5px; display: inline-block;">       N W     E S     </div>	♠ A J 10 ♥ K J 9 4 2 ♦ 10 9 ♣ Q 10 3	
	♠ —		
	♥ A 8 7		
	♦ K Q 8 5 4 2		
	♣ 9 8 4 2		

EW 3♠; EW 2♥; N 1N; NS 2♦; N 1♣; Par -140

West	North	East	South
<i>osvaill83</i>	<i>ronpa</i>	<i>jansen11</i>	<i>jec</i>
	Pass	1 ♥	Pass
1 ♠	Pass	1 NT	2 ♦
2 ♠	Pass	Pass	Pass

2 ♠ by West

<i>Trick</i>	<i>Lead</i>	<i>2nd</i>	<i>3rd</i>	<i>4th</i>
1. N	♦ 3	9	Q	<u>A</u>
2. W	♠ 3	2	<u>J</u>	♦ 5
3. E	<u>♠ A</u>	♦ 2	4	8
4. E	♠ 10	♦ 4	5	<u>K</u>
5. N	♥ 3	K	<u>A</u>	6
6. S	♦ <u>K</u>	J	6	10
7. S	♥ 8	10	<u>Q</u>	2

Made 2 — NS -110

**Board 1545**  
 East Deals  
 None Vul

♠ K J 10 7 5 ♥ A ♦ Q 8 2 ♣ A 10 7 6		♠ A Q 9 ♥ K 10 ♦ J 10 9 3 ♣ K Q 8 3	♠ 8 4 ♥ J 9 6 4 3 2 ♦ 6 5 ♣ J 9 2
		♠ 6 3 2 ♥ Q 8 7 5 ♦ A K 7 4 ♣ 5 4	

NS 2N; NS 2♥; NS 3♦; NS 1♠; NS 1♣; Par +120

West	North	East	South
<i>osvaill83</i>	<i>ronpa</i>	<i>jansen11</i>	<i>jec</i>
		2♦	Pass
2♥	2NT	Pass	3♣
Pass	3♥ <sup>1</sup>	Pass	3NT
Pass	Pass	Pass	

1. no 4 card major

3 NT by North

<i>Trick</i>	<i>Lead</i>	<i>2nd</i>	<i>3rd</i>	<i>4th</i>
1. E	♠ 8	2	K	<u>A</u>
2. N	♥ 10	3	Q	<u>A</u>
3. W	♠ J	<u>Q</u>	4	3
4. N	♦ J	6	<u>A</u>	2
5. S	♣ 4	6	<u>K</u>	2
6. N	♦ 10	5	4	<u>Q</u>
7. W	<u>♠ 10</u>	9	♥ 2	6
8. W	<u>♠ 7</u>	♣ 3	♥ 4	♥ 5
9. W	<u>♠ 5</u>	♦ 3	♥ 6	♥ 7
10. W	<u>♣ A</u>	8	9	5
11. W	♣ 7	<u>Q</u>	J	♥ 8
12. N	♦ 9	♥ 9	<u>K</u>	8
13. S	♦ 7	♣ 10	♥ K	♥ J

Down 2 — NS -100

**Board 1547**  
 West Deals  
 E-W Vul

♠ K Q 6 3 ♥ K 8 7 ♦ 10 2 ♣ K J 9 2	♠ J 8 5 2 ♥ Q 4 ♦ A K J 9 6 5 3 ♣ —	<div style="text-align: center; border: 1px solid black; width: 40px; height: 40px; margin: 0 auto; background-color: #006400; color: white; display: flex; flex-direction: column; align-items: center; justify-content: center;"> <span>N</span> <span>W</span> <span>S</span> <span>E</span> </div>	♠ A 9 4 ♥ 10 6 2 ♦ 7 ♣ A 10 7 6 5 3
♠ 10 7 ♥ A J 9 5 3 ♦ Q 8 4 ♣ Q 8 4			

NS 4♦; EW 4♣; EW 2♠; NS 1♥; Par +130

West	North	East	South
<i>osvaill83</i>	<i>ronpa</i>	<i>jansen11</i>	<i>jec</i>
1 ♣	4 ♦	5 ♣	5 ♦
Dbl	Pass	Pass	Pass

5♦× by North

<i>Trick</i>	<i>Lead</i>	<i>2nd</i>	<i>3rd</i>	<i>4th</i>
1. E	♣ A	4	9	<u>♦ 6</u>
2. N	<u>♦ A</u>	7	4	2
3. N	<u>♦ J</u>	♣ 10	8	10
4. N	♥ 4	2	J	<u>K</u>
5. W	♠ 3	2	<u>A</u>	7
6. E	♠ 9	10	Q	-

Down 1 — NS -100



**Board 1549**  
 East Deals  
 N-S Vul

♠ K J 7 4 2 ♥ 4 ♦ J 10 9 7 4 ♣ 9 3		♠ 10 ♥ K 10 7 5 3 ♦ 3 2 ♣ A K Q 10 4	♠ Q 9 6 5 ♥ A ♦ A K Q 5 ♣ 8 7 5 2
♠ A 8 3 ♥ Q J 9 8 6 2 ♦ 8 6 ♣ J 6			

EW 4♠; NS 4♥; NS 4♣; EW 2♦; Par -200: NS 5♣×-1; NS 5♥×-1

West	North	East	South
<i>osvaill83</i>	<i>ronpa</i>	<i>jansen11</i>	<i>jec</i>
		1 ♦	Pass
1 ♠	2 ♦ <sup>1</sup>	3 ♥ <sup>2</sup>	4 ♥
4 ♠	Pass	Pass	5 ♥
5 ♠	Pass	Pass	Pass

1. ♥ and ♣
2. splinter

5 ♠ by West

<i>Trick</i>	<i>Lead</i>	<i>2nd</i>	<i>3rd</i>	<i>4th</i>
1. N	<u>♣ K</u>	2	J	9
2. N	<u>♣ A</u>	5	6	3
3. N	♣ Q	7	♦ 8	<u>♠ 2</u>
4. W	♠ 4	10	Q	<u>A</u>
5. S	♠ 3	-	-	-

Down 1 — NS +50

**Board 1550**  
 South Deals  
 E-W Vul

♠ K J 3		♠ A Q 7 5 4
♥ 10 7 5 2		♥ A 3
♦ 10 9 3		♦ K 6 4
♣ 10 6 2		♣ A J 5
♠ 10 9 8 2		♠ 6
♥ K J 8 4		♥ Q 9 6
♦ A J		♦ Q 8 7 5 2
♣ 7 4 3		♣ K Q 9 8

EW 2♠; EW 1N; NS 1♦; NS 1♣; Par -110

West	North	East	South
<i>osvaill83</i>	<i>ronpa</i>	<i>jansen11</i>	<i>jec</i>
Pass	Pass	1 ♠	Pass
Pass	Dbl	Rdbl	2 ♥
2 ♠	Pass	Pass	Pass

2 ♠ by East

Trick	Lead	2nd	3rd	4th
1. S	♠ 10	3	6	<u>Q</u>
2. E	♠ 4	2	<u>K</u>	♦ 2
3. W	♦ 10	5	K	<u>A</u>
4. S	♥ 4	2	Q	<u>A</u>
5. E	♠ 5	8	<u>J</u>	♥ 9
6. W	♥ 5	6	3	<u>8</u>
7. S	♥ K	7	♣ 9	<u>♠ 7</u>
8. E	♦ 4	<u>J</u>	3	7
9. S	♥ <u>J</u>	10	♣ 8	♦ 6
10. S	♣ 3	2	Q	<u>A</u>
11. E	♠ <u>A</u>	9	♣ 6	♦ 8
12. E	♣ 5	4	10	<u>K</u>
13. N	♦ <u>Q</u>	♣ J	♣ 7	9

Down 1 — NS +100

**Board 1551**  
 West Deals  
 Both Vul

♠ A Q 5	♠ K J 10 7 6 2	♠ 9 4 3
♥ 8 4	♥ A 9	♥ K 10 7 2
♦ 8 2	♦ A K 9 6	♦ 7 5 3
♣ K Q 10 7 4 3	♣ J	♣ 9 6 2

N	
W	E
S	

♠ 8	♠ 8
♥ Q J 6 5 3	♥ Q J 6 5 3
♦ Q J 10 4	♦ Q J 10 4
♣ A 8 5	♣ A 8 5

NS 4♠; NS 4♥; NS 5♦; NS 1N; EW 1♣; Par +620

West	North	East	South
<i>osvaill83</i>	<i>ronpa</i>	<i>jansen11</i>	<i>jec</i>
1 ♣	Dbl	Pass	2 ♥
3 ♣	3 ♠	Pass	4 ♦
Pass	5 ♦	Pass	Pass

Pass

5 ♦ by South

Trick	Lead	2nd	3rd	4th
1. W	♣ K	J	2	<u>A</u>
2. S	♠ 8	<u>A</u>	2	3
3. W	♥ 4	9	<u>K</u>	3
4. E	♣ 6	5	7	<u>♦ 6</u>
5. N	<u>♦ A</u>	3	4	2
6. N	<u>♦ K</u>	5	10	8
7. N	♦ 9	7	<u>J</u>	♣ 3
8. S	♥ 5	8	<u>A</u>	2
9. N	♠ K	4	♣ 8	5

Made 5 — NS +600

**Board 1553**  
 East Deals  
 E-W Vul

♠ 6 5 2	♠ A 9 4	♠ K Q 10 7
♥ K	♥ A J 9 5 3 2	♥ Q 10
♦ J 10 8 5 4	♦ A Q 3	♦ 9 7 6
♣ A 8 3 2	♣ 10	♣ K J 5 4

♠ J 8 3
♥ 8 7 6 4
♦ K 2
♣ Q 9 7 6

NS 4♥; N 2N; S 1N; NS 1♠; EW 1♦; Par +420

West	North	East	South
<i>osvaill83</i>	<i>ronpa</i>	<i>jansen11</i>	<i>jec</i>
		1 ♣	Pass
3 ♣ <sup>1</sup>	3 ♥	Pass	4 ♥
Pass	Pass	Pass	

1. 7-9 with clubs

4 ♥ by North

<i>Trick</i>	<i>Lead</i>	<i>2nd</i>	<i>3rd</i>	<i>4th</i>
1. E	♠ K	3	2	<u>A</u>
2. N	♥ <u>A</u>	10	4	K

Made 4 — NS +420

**Board 1555**  
 West Deals  
 None Vul

♠ K J 8 7 5 3	<div style="display: inline-block; background-color: green; color: white; padding: 10px; border: 1px solid black;">           N W     E S         </div>	♠ —
♥ J 3 2		♥ A 10 9 8 7
♦ 4		♦ A 10 7 5
♣ 10 8 3		♣ 9 7 6 2
♠ A 10 6 4		♥ K 4
♥ Q 9 2	♦ 8 3 2	♣ A Q J 5
♥ Q 6 5		
♦ K Q J 9 6		
♣ K 4		

NS 3N; NS 4♦; NS 2♠; E 1♥; N 1♣; Par +400

West	North	East	South
<i>osvaill83</i>	<i>ronpa</i>	<i>jansen11</i>	<i>jec</i>
2♦ <sup>1</sup>	Dbl	Pass <sup>2</sup>	3 NT
Pass	Pass	Pass	

1. multi

2. shows diamonds

3 NT by South

<i>Trick</i>	<i>Lead</i>	<i>2nd</i>	<i>3rd</i>	<i>4th</i>
1. W	♥ 2	5	7	<u>K</u>
2. S	♦ 2	4	<u>J</u>	5
3. N	♦ <u>Q</u>	7	3	♠ 3
4. N	♠ Q	♣ 9	4	<u>K</u>
5. W	♥ J	Q	<u>A</u>	4
6. E	♥ <u>10</u>	♦ 8	3	6
7. E	♥ <u>9</u>	♠ 6	♠ 5	♦ 6
8. E	♥ <u>8</u>	♠ 10	♠ 7	♠ 2
9. E	♦ A	-	-	-

Down 2 — NS -100

**Board 1557**  
 East Deals  
 Both Vul

♠ J 9 7 6 4 ♥ 8 4 ♦ A J 5 ♣ K 9 3	♠ A 3 ♥ K Q 10 9 2 ♦ Q 6 4 ♣ 7 6 5	<div style="background-color: green; color: white; padding: 5px; display: inline-block;">           N            W     E            S         </div>	♠ K 10 8 ♥ A 6 ♦ 10 9 3 ♣ A Q J 10 2
♠ Q 5 2 ♥ J 7 5 3 ♦ K 8 7 2 ♣ 8 4			

EW 3♠; EW 2N; EW 3♣; NS 1♥; Par -140

West	North	East	South
<i>osvaill83</i>	<i>ronpa</i>	<i>jansen11</i>	<i>jec</i>
		1 NT	Pass
2♥	Dbl	2♠ <sup>1</sup>	3♥
Dbl <sup>2</sup>	Pass	4♠	Pass
Pass	Pass		

1. promise 3

2. inv to game with spades

4♠ by East

<i>Trick</i>	<i>Lead</i>	<i>2nd</i>	<i>3rd</i>	<i>4th</i>
1. S	♥ 5	4	Q	<u>A</u>
2. E	♣ J	8	<u>K</u>	5
3. W	♠ J	3	8	<u>Q</u>
4. S	♥ J	8	<u>K</u>	6
5. N	♣ 7	<u>A</u>	4	3
6. E	♠ K	2	4	<u>A</u>
7. N	♣ 6	Q	<u>♠ 5</u>	9

Down 1 — NS +100

**Board 1559**

West Deals  
N-S Vul

♠ K Q 9 8 7 ♥ 5 ♦ 8 7 3 ♣ J 10 7 3		♠ J 3 2 ♥ K 2 ♦ A K J ♣ 9 8 6 5 4	♠ A 10 5 4 ♥ Q 9 3 ♦ Q 10 9 6 2 ♣ 2
♠ 6 ♥ A J 10 8 7 6 4 ♦ 5 4 ♣ A K Q			

NS 6♥; NS 2N; EW 2♠; NS 3♣; EW 1♦; Par +800; EW 6♠×-4

West	North	East	South
<i>osvaill83</i>	<i>ronpa</i>	<i>jansen11</i>	<i>jec</i>
2♦ <sup>1</sup>	Pass	3♥	Dbl
3♠	Dbl	Pass	4♥
Pass	Pass	4♠	5♥
Pass	Pass	Pass	

1. multi

5♥ by South

<i>Trick</i>	<i>Lead</i>	<i>2nd</i>	<i>3rd</i>	<i>4th</i>
1. W	♠ K	2	<u>A</u>	6
2. E	♣ 2	<u>A</u>	10	4
3. S	♥ 4	5	<u>K</u>	9
4. N	♥ 2	3	<u>A</u>	♠ 8

Made 5 — NS +650

**Board 1563**  
 West Deals  
 Both Vul

♠ A Q J 4 2	♠ K 6 3	♠ 7
♥ 3 2	♥ Q 10 9 6	♥ A J 8
♦ K J 5 2	♦ A	♦ 8 7 6 4 3
♣ 8 6	♣ K 7 5 3 2	♣ A J 10 4

N	
W	E
S	

♠ 10 9 8 5
♥ K 7 5 4
♦ Q 10 9
♣ Q 9

EW 4♦; EW 2N; NS 2♥; EW 1♠; EW 1♣; Par -130

West	North	East	South
<i>Alamiro</i>	<i>miamiwiz</i>	<i>Harmon</i>	<i>jec</i>
1 ♠	Pass	1 NT	Pass
2 ♦	Dbl	Rdbl	2 ♥
Pass	Pass	3 ♦	Pass
Pass	Pass		

3 ♦ by West

<i>Trick</i>	<i>Lead</i>	<i>2nd</i>	<i>3rd</i>	<i>4th</i>
1. N	<u>♦ A</u>	3	9	2
2. N	<u>♥ 10</u>	<u>A</u>	5	2
3. E	<u>♦ 4</u>	10	<u>J</u>	<u>♣ 2</u>
4. W	<u>♣ 6</u>	3	10	<u>Q</u>
5. S	<u>♥ 4</u>	3	<u>Q</u>	8
6. N	<u>♥ 9</u>	J	K	<u>♦ 5</u>
7. W	<u>♣ 8</u>	5	<u>J</u>	9
8. E	<u>♠ 7</u>	10	J	<u>K</u>
9. N	<u>♣ K</u>	A	<u>♦ Q</u>	<u>♦ K</u>
10. W	<u>♠ A</u>	6	-	-

Made 3 — NS -110



**Board 1566**  
 South Deals  
 Both Vul

♠ K Q 8 2 ♥ A 7 4 ♦ 9 6 4 ♣ K 10 9	♠ A 9 7 6 3 ♥ K 5 ♦ K Q 8 5 ♣ 3 2		♠ 10 5 ♥ J 10 8 6 ♦ J 3 2 ♣ A Q J 8
♠ J 4 ♥ Q 9 3 2 ♦ A 10 7 ♣ 7 6 5 4			

NS 2♠; EW 1N; NS 2♦; EW 1♣; Par +110

West	North	East	South
<i>Alamiro</i>	<i>miamiwiz</i>	<i>Harmon</i>	<i>jec</i>
			Pass
1 ♣	1 ♠	Dbl	Pass
1 NT	Pass	Pass	Pass

1 NT by West

<i>Trick</i>	<i>Lead</i>	<i>2nd</i>	<i>3rd</i>	<i>4th</i>
1. N	♦ 5	2	<u>A</u>	4
2. S	♦ 10	6	<u>Q</u>	3
3. N	♦ <u>K</u>	J	7	9
4. N	♦ <u>8</u>	♥ 6	♣ 4	♠ 2
5. N	♣ 3	<u>Q</u>	5	9
6. E	♥ 10	Q	<u>A</u>	5
7. W	♥ 4	<u>K</u>	8	2
8. N	♣ 2	8	6	<u>K</u>
9. W	♠ Q	<u>A</u>	5	4

Made 1 — NS -90

**Board 1572**  
 North Deals  
 Both Vul

	♠ 9 2		
	♥ A 6		
	♦ K 10 9 4 3		
	♣ J 10 6 3		
♠ 10 8 6 3 ♥ K J 10 9 8 3 ♦ 5 ♣ K 2	<div style="display: inline-block; background-color: green; color: white; padding: 5px; border: 1px solid black;">       N W     E S     </div>	♠ A K 7 5 4 ♥ 7 ♦ Q J 7 2 ♣ Q 7 4	
	♠ Q J		
	♥ Q 5 4 2		
	♦ A 8 6		
	♣ A 9 8 5		

EW 3♠; EW 3♥; EW 1N; NS 2♦; NS 1♣; Par -140

West	North	East	South
<i>Alamiro</i>	<i>miamiwiz</i>	<i>Harmon</i>	<i>jec</i>
	Pass	1 ♠	Dbl
4 ♠	Pass	Pass	Pass

4 ♠ by East

<i>Trick</i>	<i>Lead</i>	<i>2nd</i>	<i>3rd</i>	<i>4th</i>
1. S	♠ J	3	2	<u>A</u>
2. E	♥ 7	4	K	<u>A</u>
3. N	♦ 3	Q	<u>A</u>	5
4. S	♦ 8	♥ 3	<u>K</u>	2
5. N	♣ 6	7	<u>A</u>	2
6. S	♦ 6	♥ 8	9	<u>J</u>
7. E	♣ 4	9	<u>K</u>	3
8. W	♠ 6	9	<u>K</u>	Q

Down 1 — NS +100

**Board 1573**  
 East Deals  
 None Vul

♠ K Q 9 5 3	♠ 8 6	♠ A J
♥ 10 6 5	♥ Q 4 3 2	♥ A K J
♦ K 9 7 3	♦ Q J 8 4 2	♦ 10 6 5
♣ 7	♣ Q 8	♣ J 9 6 5 4

N	
W	E
S	

♠ 10 7 4 2
♥ 9 8 7
♦ A
♣ A K 10 3 2

EW 3♠; EW 2N; EW 2♦; EW 1♥; EW 1♣; Par -140

West	North	East	South
<i>Alamiro</i>	<i>miamiwiz</i>	<i>Harmon</i>	<i>jec</i>
		1 NT	2 ♠ <sup>1</sup>
Pass	2 NT	Pass	3 ♣
Dbl	Pass	Pass	Pass

1. 4s, longer minor

3 ♣× by South

Trick	Lead	2nd	3rd	4th
1. W	♣ 7	8	9	<u>10</u>
2. S	♣ 2	♦ 3	<u>Q</u>	4
3. N	♥ 2	<u>J</u>	7	6
4. E	♣ 5	<u>K</u>	♠ 5	♦ 2
5. S	♥ 9	10	3	<u>K</u>
6. E	♣ 6	<u>A</u>	♦ 7	♦ 4
7. S	♥ 8	5	4	<u>A</u>
8. E	♣ J	3	♠ 3	♠ 6
9. E	♠ A	2	9	8
10. E	♠ J	4	<u>Q</u>	♥ Q
11. W	♠ K	♦ 8	♦ 5	7
12. W	♦ K	J	6	<u>A</u>
13. S	♠ 10	♦ 9	♦ Q	♦ 10

Down 3 — NS -500

**Board 1575**

West Deals  
E-W Vul

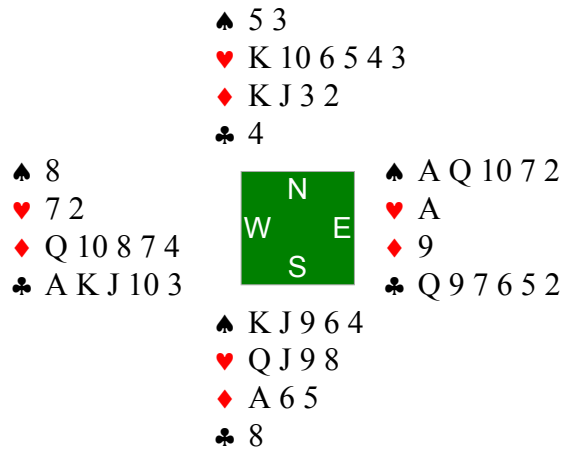

EW 6♣; NS 3♥; EW 2N; NS 1♦; Par -500: NS 6♥×-3

West	North	East	South
<i>Alamiro</i>	<i>miamiwiz</i>	<i>Harmon</i>	<i>jec</i>
1 ♦	2 ♥	2 ♠	4 ♥
Pass	Pass	5 ♣	Pass
Pass	Pass		

5 ♣ by East

Lead: ♥ Q

Made 6 — NS -620

**Board 1579**  
 West Deals  
 Both Vul

♠ 5	♠ 8 4 3	♠ A 10 6 2
♥ Q 8 6 4	♥ J 9 3	♥ 7 5 2
♦ K 8 5 3 2	♦ A 7 6	♦ Q J
♣ A 10 6	♣ 8 7 5 4	♣ K Q 9 2

♠ K Q J 9 7
♥ A K 10
♦ 10 9 4
♣ J 3

E 2N; EW 2♥; EW 3♦; EW 3♣; NS 1♠; Par -120

West	North	East	South
<i>Alamiro</i>	<i>miamiwiz</i>	<i>Harmon</i>	<i>jec</i>
Pass	Pass	1 ♣	1 ♠
Dbl	2 ♠	Pass	Pass
Dbl	Pass	2 NT	Pass
Pass	Pass		

2 NT by East

<i>Trick</i>	<i>Lead</i>	<i>2nd</i>	<i>3rd</i>	<i>4th</i>
1. S	<u>♠ K</u>	5	3	6
2. S	<u>♠ J</u>	♣ 6	8	2
3. S	♠ Q	♥ 4	4	<u>A</u>
4. E	♦ J	4	2	<u>A</u>
5. N	♥ 9	7	<u>K</u>	6
6. S	♠ 7	♥ 8	♥ 3	<u>10</u>
7. E	♦ Q	9	3	7
8. E	♣ 2	3	<u>A</u>	4
9. W	♦ K	6	♥ 2	10
10. W	♦ 8	♣ 5	-	-

Made 3 — NS -150

**Board 1585**  
 East Deals  
 Both Vul

♠ A Q J 10 6	♠ 9 8 7 4 3	♠ 5
♥ 7 5 2	♥ 9 8 3	♥ 10
♦ K	♦ A 6	♦ Q 10 8 7 5 4 3 2
♣ A 8 6 2	♣ Q 7 4	♣ 9 5 3

♠ K 2
♥ A K Q J 6 4
♦ J 9
♣ K J 10

NS 3♥; NS 2N; EW 3♦; NS 1♠; Par +140

West	North	East	South
<i>Alamiro</i>	<i>miamiwiz</i>	<i>Harmon</i>	<i>jec</i>

	4♦	4♥	
--	----	----	--

5♦	Dbl	Pass	Pass
----	-----	------	------

Pass

5♦× by East

<i>Trick</i>	<i>Lead</i>	<i>2nd</i>	<i>3rd</i>	<i>4th</i>
1. S	♥K	2	3	10
2. S	♥A	5	8	♦2
3. E	♠5	2	10	3
4. W	♦K	A	3	9
5. N	♣4	3	10	A
6. W	♠A	4	♣5	K
7. W	♠Q	7	♣9	♦J
8. S	♣K	-	-	-

Down 1 — NS +200

**Board 1590**  
 South Deals  
 E-W Vul

♠ K 7 5	♠ A Q 10 8 4	♠ J 9 3 2
♥ 9 8 6 2	♥ J 4 3	♥ A K 10 5
♦ A Q 5	♦ 9 4	♦ 10 7 2
♣ K Q 6	♣ 9 8 3	♣ J 7

♠ 6
♥ Q 7
♦ K J 8 6 3
♣ A 10 5 4 2

EW 3♥; EW 2♠; EW 1N; NS 1♦; NS 1♣; Par -140

West	North	East	South
<i>vikordani</i>	<i>smispi</i>	<i>gunnarhall</i>	<i>jec</i>
			Pass
1 ♣	Pass	1 ♥	Pass
2 ♥	Pass	Pass	2 NT
Dbl	3 ♣	Pass	Pass

Pass

3 ♣ by North

<i>Trick</i>	<i>Lead</i>	<i>2nd</i>	<i>3rd</i>	<i>4th</i>
1. E	<u>♥ A</u>	7	9	4
2. E	<u>♥ K</u>	Q	2	3
3. E	♠ 3	6	K	<u>A</u>
4. N	♦ 9	7	J	<u>Q</u>
5. W	♠ 7	<u>Q</u>	2	♦ 3
6. N	♦ 4	2	6	<u>A</u>
7. W	♦ 5	♠ 4	10	<u>K</u>
8. S	<u>♣ A</u>	6	3	7
9. S	♣ 2	<u>Q</u>	8	J

Down 2 — NS -100

**Board 1603**

West Deals  
E-W Vul

♠ A 10 9 8 2		♠ K Q 5 4 3
♥ K J 10 7		♥ A 6
♦ A J 8		♦ K Q 10 2
♣ 7		♣ 6 4
♠ J 7		♠ 6
♥ Q 9 4 3	♥ 8 5 2	♣ A K J 9 5 3 2
♦ 9 5 4 3	♦ 7 6	
♣ Q 10 8	♣	

EW 6♠; EW 6♦; EW 4♥; NS 1♣; Par -1400; NS 7♣×-6

West	North	East	South
<i>Harmon</i>	<i>smispi</i>	<i>gunnarhall</i>	<i>jec</i>
1 ♠	4 ♣	4 NT	5 ♣
5 ♦	Pass	6 ♠	Pass
Pass	Pass		

6 ♠ by West

<i>Trick</i>	<i>Lead</i>	<i>2nd</i>	<i>3rd</i>	<i>4th</i>
1. N	♣ K	4	8	7
2. N	♣ A	6	10	-
Made 6 — NS -1430				



**Board 1605**  
 East Deals  
 N-S Vul

♠ 9 7 6 2	♠ A J 8 3	♠ K 5
♥ Q 10	♥ J 8 6	♥ A 9 7 5 4 2
♦ J 10 2	♦ Q 9	♦ K 5 4 3
♣ 9 6 5 2	♣ K Q J 7	♣ A

♠ Q 10 4
♥ K 3
♦ A 8 7 6
♣ 10 8 4 3

NS 2♠; EW 2♥; NS 3♣; NS 1N; EW 1♦; Par +100; EW 3♥×-1

West	North	East	South
<i>Harmon</i>	<i>smispi</i>	<i>gunnarhall</i>	<i>jec</i>
		1♥	Pass
Pass	Dbl	Pass	1NT
Pass	Pass	Pass	

1 NT by South

<i>Trick</i>	<i>Lead</i>	<i>2nd</i>	<i>3rd</i>	<i>4th</i>
1. W	♥ Q	6	7	<u>K</u>
2. S	♣ 3	5	K	<u>A</u>
3. E	♥ <u>A</u>	3	10	8
4. E	♥ 5	♦ 6	♦ 2	<u>J</u>
5. N	♣ <u>Q</u>	♦ 4	4	2
6. N	♣ <u>J</u>	♦ 5	8	6
7. N	♣ 7	♠ 5	<u>10</u>	9
8. S	♦ <u>A</u>	J	9	3
9. S	♠ <u>Q</u>	2	<u>A</u>	K
10. N	♠ 3	♥ 2	<u>10</u>	6
11. S	♠ 4	7	<u>8</u>	♥ 4
12. N	♠ <u>J</u>	♥ 9	♦ 7	9
13. N	♦ <u>Q</u>	<u>K</u>	8	10

Made 4 — NS +180

**Board 1608**  
 North Deals  
 None Vul

♠ 10 9 4	<div style="display: inline-block; background-color: green; color: white; padding: 10px; border: 1px solid black;">           N W     E S         </div>	♠ A K Q 6
♥ K J 10 6 3		♥ 2
♦ 4 2		♦ J 8 7 5
♣ A 7 4		♣ Q J 3 2
♠ 8		♠ J 7 5 3 2
♥ Q 7	♥ A 9 8 5 4	
♦ K Q 9 6 3	♦ A 10	
♣ K 10 9 8 6	♣ 5	

E 1N; EW 1♠; EW 1♥; NS 1♦; S 1♣; Par -90

West	North	East	South
<i>ghionis</i>	<i>smispi</i>	<i>thejuwel</i>	<i>jec</i>
	Pass	1 ♣	2 ♣ <sup>1</sup>
2 ♥	Pass	2 NT	Pass
Pass	Pass		

1. MM

2 NT by East

Trick	Lead	2nd	3rd	4th
1. S	♥ 5	10	<u>Q</u>	2
2. N	♦ 3	7	<u>10</u>	2
3. S	♦ <u>A</u>	4	6	8
4. S	♠ 2	<u>10</u>	8	6
5. W	♥ K	7	♣ 2	<u>A</u>
6. S	♥ 9	<u>J</u>	♣ 6	♦ 5
7. W	♠ 4	♣ 8	<u>A</u>	3
8. E	♠ <u>K</u>	5	9	♣ 9
9. E	♠ <u>Q</u>	7	♥ 3	♦ 9
10. E	♦ J	♠ J	♥ 6	<u>K</u>
11. N	♦ <u>Q</u>	♣ 3	♥ 4	♣ 4
12. N	♣ 10	-	-	-

Down 1 — NS +50

**Board 1625**  
 East Deals  
 E-W Vul

	♠ 10		
	♥ J 8 4 3 2		
	♦ K J 8 7 4 2		
	♣ 10		
♠ K Q 6 3 2 ♥ K ♦ A Q 10 ♣ Q 9 5 4	<div style="background-color: green; color: white; padding: 5px; display: inline-block;">           N W     E S         </div>	♠ A 9 7 5 4 ♥ 10 ♦ 6 3 ♣ A K 8 7 3	
	♠ J 8		
	♥ A Q 9 7 6 5		
	♦ 9 5		
	♣ J 6 2		

EW 5♠; NS 4♥; EW 5♣; NS 3♦; EW 1N; Par -300: NS 6♥×-2

West	North	East	South
<i>HeBo</i>	<i>BridgeGoth</i>	<i>svenja17</i>	<i>jec</i>
		1 ♠	Pass
2 NT	Pass	4 ♣ <sup>1</sup>	Pass
4 ♦ <sup>2</sup>	Pass	4 NT <sup>3</sup>	Pass
6 ♠	6 NT	Pass	7 ♣
Dbl	7 ♦	Pass	7 ♥
Dbl	Pass	Pass	Pass

1. 5 cl
2. KCB
3. 2 kc

7 ♥× by South

<i>Trick</i>	<i>Lead</i>	<i>2nd</i>	<i>3rd</i>	<i>4th</i>
1. W	♠ K	10	4	J
2. W	♣ Q	10	3	6
3. W	♣ 4	♥ 2	7	2
4. N	♥ 3	10	A	K
5. S	♦ 5	A	2	3
6. W	♠ 3	♥ 4	5	8
7. N	♦ K	6	9	10

Down 3 — NS -500

**Board 1627**  
 West Deals  
 None Vul

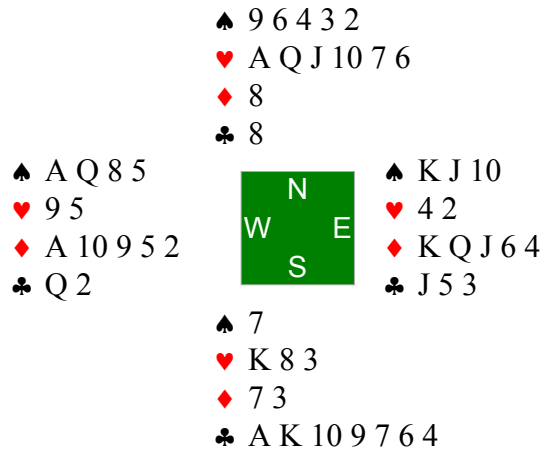

NS 5♥; EW 3♦; NS 3♣; EW 1♠; Par +450

West	North	East	South
<i>HeBo</i>	<i>BridgeGoth</i>	<i>svenja17</i>	<i>jec</i>
1 ♦	2 ♥	3 ♥	4 ♣
Pass	4 ♥	Pass	Pass
4 ♠	Dbl	Pass	Pass

Pass

4 ♠× by West

<i>Trick</i>	<i>Lead</i>	<i>2nd</i>	<i>3rd</i>	<i>4th</i>
1. N	♠ 3	<u>10</u>	7	5
2. E	♠ J	♣ 10	8	2
3. E	♣ 3	<u>K</u>	2	8
4. S	♥ K	9	<u>A</u>	2
5. N	♥ <u>Q</u>	4	8	5
6. N	♠ 4	<u>K</u>	♣ 4	Q

Down 5 — NS +1100

**Board 1635**  
West Deals  
E-W Vul

♠ A K 10	♠ 8 6 5 2	♠ 9 3
♥ K J 7 3	♥ Q 5	♥ 10 9 8 6 2
♦ 10 9 6	♦ 8 7 5	♦ Q J 4 3
♣ J 10 4	♣ A K 9 7	♣ 6 5

♠ Q J 7 4
♥ A 4
♦ A K 2
♣ Q 8 3 2

S 2N; NS 2♠; EW 2♥; N 1N; NS 2♣; EW 1♦; Par +120

West	North	East	South
<i>HeBo</i>	<i>BridgeGoth</i>	<i>svenja17</i>	<i>jec</i>
1 NT	Pass	2 ♦	Pass
2 ♥	Pass	Pass	Dbl
Pass	2 ♠	Pass	Pass
3 ♥	Pass	Pass	Pass

3 ♥ by West

<i>Trick</i>	<i>Lead</i>	<i>2nd</i>	<i>3rd</i>	<i>4th</i>
1. N	<u>♣ A</u>	5	8	4
2. N	<u>♣ K</u>	6	2	10
3. N	♦ 5	J	<u>K</u>	6
4. S	♠ 7	<u>A</u>	2	3
5. W	♣ J	7	<u>♥ 6</u>	3
6. E	♥ 2	4	<u>K</u>	5
7. W	♥ 7	Q	8	<u>A</u>
8. S	♠ 4	<u>K</u>	5	9
9. W	♦ 10	8	3	<u>A</u>

Down 1 — NS +100

**Board 1636**  
 North Deals  
 None Vul

♠ 8 5 4 2 ♥ K 4 ♦ Q 8 3 ♣ A J 4 2	<div style="background-color: green; color: white; padding: 5px; display: inline-block;">           N W     E S         </div>	♠ J 9 6 ♥ Q J 10 ♦ 9 ♣ K 10 9 8 7 5	♠ K 10 3 ♥ 8 2 ♦ A K J 10 7 6 2 ♣ Q
		♠ A Q 7 ♥ A 9 7 6 5 3 ♦ 5 4 ♣ 6 3	

EW 3N; NS 3♥; E 4♦; W 2♠; W 3♦; NS 2♣; E 1♠; Par -100:  
 NS 4♥×-1

West	North	East	South	
<i>HeBo</i>	<i>BridgeGoth</i>	<i>svenja17</i>	<i>jec</i>	
	Pass	1 ♦	1 ♥	
Dbl	2 ♥	3 ♦	3 ♥	
3 NT	Pass	Pass	Pass	
3 NT by West				
<i>Trick</i>	<i>Lead</i>	<i>2nd</i>	<i>3rd</i>	<i>4th</i>
1. N	♥ Q	2	7	<u>K</u>
2. W	♦ 8	9	<u>K</u>	4
3. E	♣ Q	3	<u>A</u>	5
4. W	♦ Q	♣ 10	-	-
Made 3 — NS -400				

**Board 1637**

East Deals  
N-S Vul

	♠ 9 8											
	♥ K J 9											
	♦ 9 7 4 3 2											
	♣ 9 6 3											
♠ 6 4 2 ♥ Q 10 8 5 4 ♦ 10 ♣ Q J 10 5	<table style="border: 1px solid black; width: 40px; height: 40px; margin: auto;"> <tr><td></td><td style="text-align: center;">N</td><td></td></tr> <tr><td style="text-align: center;">W</td><td></td><td style="text-align: center;">E</td></tr> <tr><td></td><td style="text-align: center;">S</td><td></td></tr> </table>		N		W		E		S		♠ K J 5 3 ♥ 6 2 ♦ A Q J 6 ♣ K 8 4	
	N											
W		E										
	S											
	♠ A Q 10 7											
	♥ A 7 3											
	♦ K 8 5											
	♣ A 7 2											

NS 3N; NS 2♥; NS 3♦; NS 1♠; NS 1♣; Par +600

West	North	East	South
<i>HeBo</i>	<i>BridgeGoth</i>	<i>svenja17</i>	<i>jec</i>
		1 NT	Dbl
2 ♥	Pass	Pass	Pass

2 ♥ by West

<i>Trick</i>	<i>Lead</i>	<i>2nd</i>	<i>3rd</i>	<i>4th</i>
1. N	♠ 9	J	<u>Q</u>	4
2. S	♥ 3	Q	<u>K</u>	2
3. N	♠ 8	3	7	6
4. N	♣ 3	8	<u>A</u>	5
5. S	♠ A	2	♣ 6	5
6. S	♠ 10	♣ J	<u>♥ 9</u>	K
7. N	♦ 2	<u>A</u>	5	10
8. E	♥ 6	7	8	<u>J</u>
9. N	♦ 3	J	K	<u>♥ 4</u>
10. W	♥ 5	♣ 9	♦ 6	<u>A</u>

Down 3 — NS +150

**Board 1639**  
 West Deals  
 Both Vul

	♠ 8 6 4		
	♥ 8 6 4		
	♦ A 10 9 8 4 2		
	♣ 9		
♠ 3 ♥ J 10 9 3 ♦ K 7 5 ♣ Q J 8 6 5	<div style="border: 2px solid green; padding: 5px; display: inline-block;">           N            W     E            S         </div>	♠ K Q 9 5 ♥ K 5 ♦ Q J 3 ♣ A 4 3 2	
	♠ A J 10 7 2		
	♥ A Q 7 2		
	♦ 6		
	♣ K 10 7		

NS 2♠; E 1N; NS 2♦; E 2♣; NS 1♥; W 1♣; Par +110

West	North	East	South
<i>HeBo</i>	<i>BridgeGoth</i>	<i>svenja17</i>	<i>jec</i>
Pass	Pass	1 ♣	1 ♠
3 ♣ <sup>1</sup>	Pass	Pass	Dbl
Pass	3 ♠	Pass	Pass
Pass			

1. limit/pre  
 3 ♠ by South

<i>Trick</i>	<i>Lead</i>	<i>2nd</i>	<i>3rd</i>	<i>4th</i>
1. W	♣ Q	9	<u>A</u>	7
2. E	♠ 5	<u>J</u>	3	4
3. S	♣ 10	6	<u>♠ 6</u>	2
4. N	♥ 4	5	<u>Q</u>	J
5. S	<u>♥ A</u>	3	6	K
6. S	<u>♣ K</u>	5	♥ 8	3
7. S	♦ 6	7	<u>A</u>	3
8. N	♦ 2	J	<u>♠ 2</u>	5
9. S	♥ 2	9	♠ 8	<u>♠ 9</u>
10. E	<u>♠ K</u>	7	♣ 8	♦ 4
11. E	♦ Q	♥ 7	<u>K</u>	8
12. W	♥ 10	♦ 9	♣ 4	<u>♠ 10</u>
13. S	<u>♠ A</u>	♣ J	♦ 10	Q

Made 3 — NS +140



**Board 1653**

East Deals  
E-W Vul

♠ K 10 8	♠ 7 5 2	♠ A Q J 6 4
♥ 7 2	♥ Q 9	♥ K 8 4
♦ K 7 4 3 2	♦ J 10 6	♦ Q 9
♣ K 8 2	♣ 10 7 6 5 3	♣ Q J 4

N	
W	E
S	

♠ 9 3
♥ A J 10 6 5 3
♦ A 8 5
♣ A 9

E 4♠; W 3♠; E 2♦; NS 1♥; W 1♦; E 1♣; Par -620

West	North	East	South
<i>bridgeboy</i>	<i>nevaio</i>	<i>krobono</i>	<i>jec</i>
		1 NT <sup>1</sup>	2♦ <sup>2</sup>
Dbf <sup>3</sup>	2♥	2♠	3♥
Pass	Pass	Pass	

1. 15-17

2. h

3. gf values

3♥ by North

<i>Trick</i>	<i>Lead</i>	<i>2nd</i>	<i>3rd</i>	<i>4th</i>
1. E	♦ Q	<u>A</u>	2	6
2. S	♦ 5	3	<u>J</u>	9
3. N	<u>♥ Q</u>	4	3	2
4. N	♥ 9	K	-	-

Made 3 — NS +140

**Board 1656**  
 North Deals  
 E-W Vul

♠ Q 4 2 ♥ K Q 7 4 2 ♦ 9 ♣ J 8 4 2		♠ J 6 5 3 ♥ 3 ♦ A 10 7 ♣ A 9 6 5 3	♠ K 10 9 8 ♥ A J ♦ K Q J 8 6 5 ♣ 10
		♠ A 7 ♥ 10 9 8 6 5 ♦ 4 3 2 ♣ K Q 7	

EW 2♠; EW 2♥; NS 1N; EW 2♦; NS 2♣; Par -100; NS 2N×-1;  
 NS 3♣×-1

West	North	East	South
<i>bridgeboy</i>	<i>nevaio</i>	<i>krobono</i>	<i>jec</i>
	Pass	1♦	Pass
1♥	Dbl	1♠	2♣
Pass	3♣	3♦	Pass
Pass	Pass		

3♦ by East

<i>Trick</i>	<i>Lead</i>	<i>2nd</i>	<i>3rd</i>	<i>4th</i>
1. S	<u>♣K</u>	2	6	10
2. S	<u>♣Q</u>	4	3	<u>♦5</u>
3. E	<u>♦K</u>	2	9	<u>A</u>
4. N	♥3	<u>A</u>	5	2
5. E	<u>♦Q</u>	3	♥4	7
6. E	<u>♦J</u>	4	♣8	10
7. E	♠8	7	<u>Q</u>	6
8. W	♠2	5	10	<u>A</u>
9. S	♣7	-	-	-

Made 4 — NS -130

**Board 1658**  
 South Deals  
 None Vul

♠ A 10 ♥ A Q J 8 ♦ J 4 2 ♣ A 10 7 4		♠ K Q 9 8 5 4 2 ♥ 10 2 ♦ K 5 ♣ 9 8	♠ J 7 ♥ 9 7 6 4 3 ♦ A 9 7 6 ♣ K 2
		♠ 6 3 ♥ K 5 ♦ Q 10 8 3 ♣ Q J 6 5 3	

EW 5♥; EW 4N; EW 3♦; EW 2♣; W 1♠; Par -450

West	North	East	South
<i>bridgeboy</i>	<i>nevaio</i>	<i>krobono</i>	<i>jec</i>
			Pass
1 ♣ <sup>1</sup>	3 ♠	Dbl <sup>2</sup>	Pass
Pass	Pass		

1. 16+ any
2. GF

3 ♠× by North

<i>Trick</i>	<i>Lead</i>	<i>2nd</i>	<i>3rd</i>	<i>4th</i>
1. E	<u>♣ K</u>	3	4	8
2. E	<u>♥ 7</u>	5	<u>Q</u>	2
3. W	<u>♣ A</u>	9	2	5
4. W	<u>♥ A</u>	10	6	K
5. W	<u>♣ 10</u>	♠ 8	<u>♠ J</u>	6
6. E	<u>♥ 9</u>	<u>♠ 3</u>	J	♦ 5
7. S	<u>♣ J</u>	7	♦ K	<u>♠ 7</u>
8. E	♦ A	-	-	-

Down 3 — NS -500

**Board 1659**

West Deals  
N-S Vul

<p>♠ A 9 8 3 ♥ A J 10 9 4 ♦ A Q 3 ♣ 4</p>		<p>♠ K 7 6 2 ♥ — ♦ J 10 6 ♣ A Q J 7 6 3</p>	<p>♠ Q 10 5 4 ♥ Q 7 5 3 2 ♦ — ♣ K 10 9 8</p>
<p>♠ J ♥ K 8 6 ♦ K 9 8 7 5 4 2 ♣ 5 2</p>			

EW 5♥; EW 4N; EW 4♠; N 3♦; S 2♦; W 1♣; Par -450

West	North	East	South
<i>bridgeboy</i>	<i>nevaio</i>	<i>krobono</i>	<i>jec</i>
1 ♣ <sup>1</sup>	Dbl <sup>2</sup>	1 ♦ <sup>3</sup>	3 ♦
Pass	4 ♦	Dbl	Pass
Pass	Pass		

1. 16+ any
2. clubs
3. 5-7

4 ♦ × by South

<i>Trick</i>	<i>Lead</i>	<i>2nd</i>	<i>3rd</i>	<i>4th</i>
1. W	♥ A	♦ 6	2	6
2. N	♠ 2	Q	J	9
3. E	♠ 4	♦ 2	3	6
4. S	♣ 2	4	Q	<u>K</u>
5. E	♣ 8	5	♦ 3	3
6. W	♥ J	♦ 10	3	8
7. N	♦ J	♣ 10	4	<u>Q</u>
8. W	♥ 10	♣ 6	5	<u>K</u>

Down 2 — NS -500

**Board 1661**  
 East Deals  
 None Vul

♠ 8 4 ♥ A 9 8 3 2 ♦ 10 8 5 ♣ A K 2	♠ A K J 7 3 ♥ K Q 5 ♦ A 6 4 ♣ Q 3	♠ 10 9 6 5 ♥ 10 7 4 ♦ K 9 7 3 ♣ 10 6	
♠ Q 2 ♥ J 6 ♦ Q J 2 ♣ J 9 8 7 5 4			

NS 3N; NS 2♠; NS 3♣; NS 2♦; EW 1♥; Par +400

West	North	East	South
<i>bridgeboy</i>	<i>nevaio</i>	<i>krobono</i>	<i>jec</i>
		Pass	Pass
1 ♥	Dbl	Pass	2 ♣
Pass	2 NT	Pass	3 NT
Pass	Pass	Pass	

3 NT by North

<i>Trick</i>	<i>Lead</i>	<i>2nd</i>	<i>3rd</i>	<i>4th</i>
1. E	♥ 4	J	<u>A</u>	5
2. W	♥ 3	<u>K</u>	7	6
3. N	♦ <u>A</u>	3	2	5
4. N	♦ 4	<u>K</u>	J	8
5. E	♥ 10	♣ 4	2	<u>Q</u>
6. N	♦ 6	7	<u>Q</u>	10
7. S	♠ <u>Q</u>	4	3	6
8. S	♠ 2	8	<u>J</u>	5
9. N	♠ <u>K</u>	9	♣ 5	♣ 2

Made 3 — NS +400

**Board 1665**  
 East Deals  
 N-S Vul

♠ Q J 10 8 5 ♥ 10 ♦ J 10 3 ♣ Q 9 8 3		♠ 4 3 2 ♥ K J 9 8 ♦ Q 9 8 7 ♣ 6 5	♠ K 9 7 6 ♥ A Q 5 4 3 ♦ A 5 ♣ A 7
♠ A ♥ 7 6 2 ♦ K 6 4 2 ♣ K J 10 4 2			

E 5♠; W 4♠; E 3N; W 2N; N 2♦; E 2♣; EW 1♥; S 1♦; W 1♣;  
 Par -450

West	North	East	South
<i>bridgeboy</i>	<i>nevaio</i>	<i>krobono</i>	<i>jec</i>
		1 ♣ <sup>1</sup>	Dbl
1 ♦ <sup>2</sup>	Pass	1 ♥ <sup>3</sup>	Pass
1 ♠ <sup>4</sup>	Pass	2 ♠	Pass
3 ♠	Pass	4 ♠	Pass
Pass	Pass		

1. 16+ any
2. 5-7 any
3. 4+H, F1
4. 4+ ♠, no 3 card H

4 ♠ by West

<i>Trick</i>	<i>Lead</i>	<i>2nd</i>	<i>3rd</i>	<i>4th</i>
1. N	♣ 6	<u>A</u>	4	3
2. E	♣ 7	<u>K</u>	8	5
3. S	♦ 4	10	Q	<u>A</u>
4. E	♦ 5	<u>K</u>	3	7
5. S	♣ J	9	♦ 8	<u>♠ 6</u>
6. E	♠ 7	<u>A</u>	5	2
7. S	♣ 2	-	-	-

Made 4 — NS -420

**Board 1666**  
 South Deals  
 E-W Vul

♠ A 10 9 6 ♥ K 7 ♦ Q 10 8 7 ♣ K 6 3	♠ K Q J 5 4 2 ♥ 6 5 2 ♦ 3 ♣ J 8 7	<div style="background-color: green; color: white; padding: 5px; width: 40px; height: 40px; margin: 0 auto; display: flex; flex-direction: column; align-items: center; justify-content: center;"> <span>N</span> <span>W</span> <span>S</span> <span>E</span> </div>	♠ 8 3 ♥ A Q 4 3 ♦ 9 6 4 ♣ A Q 4 2
♠ 7 ♥ J 10 9 8 ♦ A K J 5 2 ♣ 10 9 5			

EW 4N; EW 3♥; EW 3♦; EW 3♣; EW 1♠; Par -630

West	North	East	South
<i>bridgeboy</i>	<i>nevaio</i>	<i>krobono</i>	<i>jec</i>
			Pass
1 ♦	2 ♠	Dbl	Pass
Pass	Pass		

2 ♠× by North

<i>Trick</i>	<i>Lead</i>	<i>2nd</i>	<i>3rd</i>	<i>4th</i>
1. E	♦ 4	<u>A</u>	7	3
2. S	♦ <u>K</u>	8	♣ 7	6
3. S	♠ 7	10	<u>J</u>	3
4. N	♠ 2	8	♦ 2	<u>9</u>
5. W	♥ <u>K</u>	2	3	8
6. W	♥ 7	-	-	-

Down 2 — NS -300

**Board 1671**  
 West Deals  
 None Vul

	♠ —											
	♥ 6 5											
	♦ A J 10 8 6 5 2											
	♣ K Q 8 6											
♠ 8 7 6 3 ♥ A K Q 10 8 4 ♦ 3 ♣ 5 2	<div style="display: inline-block; background-color: #008000; color: white; padding: 5px; border: 1px solid black;"> <table style="border-collapse: collapse; text-align: center; width: 40px; height: 40px;"> <tr><td></td><td>N</td><td></td></tr> <tr><td>W</td><td></td><td>E</td></tr> <tr><td></td><td>S</td><td></td></tr> </table> </div>		N		W		E		S		♠ A K Q 10 2 ♥ J 2 ♦ 9 ♣ A 9 7 4 3	
	N											
W		E										
	S											
	♠ J 9 5 4											
	♥ 9 7 3											
	♦ K Q 7 4											
	♣ J 10											

W 5♥; EW 4♠; E 4♥; NS 4♦; EW 2♣; Par -300: NS 6♦×-2

West	North	East	South
<i>bridgeboy</i>	<i>nevaio</i>	<i>krobono</i>	<i>jec</i>
1 ♥	4 ♦	Dbl	Pass
4 ♠	4 NT	Dbl	5 ♦
Pass	Pass	5 ♠	Pass
Pass	Pass		

5 ♠ by West

<i>Trick</i>	<i>Lead</i>	<i>2nd</i>	<i>3rd</i>	<i>4th</i>
1. N	<u>♦ A</u>	9	7	3
2. N	<u>♣ K</u>	<u>A</u>	J	5
3. E	<u>♠ A</u>	4	3	♦ 2
4. E	<u>♠ K</u>	5	6	♦ 5
5. E	<u>♥ J</u>	3	4	5
6. E	♥ 2	9	<u>10</u>	6
7. W	<u>♥ A</u>	♦ 6	♣ 3	7
8. W	♥ K	♦ 8	♣ 4	<u>♠ 9</u>
9. S	♣ 10	-	-	-

Down 1 — NS +50



**Board 1674**  
 South Deals  
 None Vul

♠ A 6 2 ♥ 10 7 ♦ A Q J 5 ♣ A 9 6 4		♠ K 8 ♥ J 6 5 3 ♦ K 6 4 2 ♣ 5 3 2	♠ J 9 7 5 ♥ A K Q 4 2 ♦ 9 7 3 ♣ Q
		♠ Q 10 4 3 ♥ 9 8 ♦ 10 8 ♣ K J 10 8 7	

EW 3♠; EW 3♥; W 4♦; EW 2N; E 3♦; EW 1♣; Par -140

West	North	East	South
<i>bridgeboy</i>	<i>nevaio</i>	<i>krobono</i>	<i>jec</i>
			Pass
1 NT <sup>1</sup>	Pass	2 ♣	Dbl
2 ♦ <sup>2</sup>	Pass	3 ♠ <sup>3</sup>	Pass
3 NT	Pass	Pass	Pass

1. 14-16
2. promise ♣ stop
3. 5H 4S

3 NT by West

Trick	Lead	2nd	3rd	4th
1. N	♣ 2	Q	K	<u>A</u>
2. W	♥ 7	3	<u>K</u>	9
3. E	♦ 3	8	<u>Q</u>	2
4. W	♥ 10	5	<u>Q</u>	8
5. E	♦ 7	10	<u>J</u>	4
6. W	♦ <u>A</u>	6	9	♣ 7
7. W	♦ 5	<u>K</u>	♥ 2	♠ 4
8. N	♣ 3	♠ 5	<u>10</u>	4
9. S	♠ 3	2	<u>K</u>	7
10. N	♠ 8	9	10	<u>A</u>
11. W	♠ 6	♣ 5	J	<u>Q</u>
12. S	♣ <u>J</u>	6	♥ 6	♥ 4
13. S	♣ 8	<u>9</u>	♥ J	♥ A

Down 1 — NS +50

**Board 1682**  
 South Deals  
 Both Vul

♠ A K 8 3 ♥ 7 6 ♦ A 10 7 6 ♣ 10 7 5		♠ J 5 4 ♥ A K J 2 ♦ J 9 3 ♣ K J 8	♠ Q 10 7 6 ♥ Q 5 4 ♦ K 8 4 ♣ 6 4 3
♠ 9 2 ♥ 10 9 8 3 ♦ Q 5 2 ♣ A Q 9 2			

NS 2♥; NS 2♣; EW 1♠; EW 1♦; Par +110

West	North	East	South
<i>sylvie</i>	<i>smispi</i>	<i>joanng</i>	<i>jec</i>
			Pass
1♦	Dbl	1♠	2♥
2♠	Pass	Pass	Pass

2♠ by East

<i>Trick</i>	<i>Lead</i>	<i>2nd</i>	<i>3rd</i>	<i>4th</i>
1. S	♥ 10	6	<u>K</u>	5
2. N	♣ J	4	9	5
3. N	♣ <u>K</u>	6	2	7
4. N	♣ 8	3	Q	10
5. S	♠ 2	3	5	<u>6</u>
6. E	♠ 7	9	<u>A</u>	4
7. W	♠ <u>K</u>	J	10	♣ A
8. W	♥ 7	<u>A</u>	4	3
9. N	♥ 2	Q	8	♦ 6
10. E	♦ 4	2	<u>A</u>	3
11. W	♦ 7	9	<u>K</u>	5
12. E	♦ 8	Q	-	-

Down 1 — NS +100

**Board 1687**  
 West Deals  
 N-S Vul

♠ 8 7 3 2 ♥ Q 9 ♦ 9 7 2 ♣ 10 6 5 2	♠ J 6 5 ♥ K 10 8 ♦ A 8 3 ♣ Q 9 7 4		♠ A Q 10 ♥ 6 2 ♦ K 10 5 4 ♣ A J 8 3
♠ K 9 4 ♥ A J 7 5 4 3 ♦ Q J 6 ♣ K			

N 4N; N 4♥; S 3N; S 3♥; NS 1♠; NS 1♦; N 1♣; Par +630

West	North	East	South
<i>sylvie</i>	<i>smispi</i>	<i>joanng</i>	<i>jec</i>
Pass	Pass	1 ♦	1 ♥
Pass	2 ♦	Pass	3 ♥
Pass	3 NT	Pass	Pass

Pass

3 NT by North

<i>Trick</i>	<i>Lead</i>	<i>2nd</i>	<i>3rd</i>	<i>4th</i>
1. E	♣ 3	<u>K</u>	6	4
2. S	♦ Q	7	3	<u>K</u>
3. E	♠ Q	<u>K</u>	7	6
4. S	♥ 3	9	<u>10</u>	6

Made 4 — NS +630

**Board 1693**

East Deals  
N-S Vul

♠ K 8 6 ♥ K 8 7 3 ♦ A K 8 6 ♣ Q J	♠ A Q 9 ♥ Q 9 6 ♦ Q 9 5 2 ♣ 8 7 2	<div style="text-align: center; border: 1px solid black; width: 40px; height: 40px; margin: 0 auto; background-color: #006400; color: white; display: flex; flex-direction: column; align-items: center; justify-content: center;"> <span>N</span> <span>W</span> <span>S</span> <span>E</span> </div>	♠ J 7 5 4 2 ♥ 5 ♦ J 10 7 ♣ K 10 6 5
♠ 10 3 ♥ A J 10 4 2 ♦ 4 3 ♣ A 9 4 3			

S 3♥; EW 2♠; N 2♥; NS 1N; EW 1♦; Par +100; EW 3♠×-1

West	North	East	South
<i>sylvie</i>	<i>smispi</i>	<i>joanng</i>	<i>jec</i>
		Pass	Pass
1 NT	Pass	2♥ <sup>1</sup>	Dbl
2♠	3♥	Pass	Pass
Pass			

1. trans

3♥ by North

Trick	Lead	2nd	3rd	4th
1. E	♠ 2	10	K	<u>A</u>
2. N	♠ Q	4	3	8
3. N	♠ 9	5	<u>♥ 2</u>	6
4. S	♦ 3	<u>K</u>	2	7
5. W	♣ Q	2	5	<u>A</u>
6. S	♦ 4	<u>A</u>	5	10
7. W	♣ J	8	<u>K</u>	3
8. E	<u>♣ 10</u>	4	♦ 6	7
9. E	♦ J	♣ 9	8	<u>Q</u>
10. N	♥ 9	5	4	<u>K</u>
11. W	♥ 3	-	-	-

Down 1 — NS -100

**Board 1701**  
 East Deals  
 E-W Vul

♠ 10 ♥ A J 7 6 4 ♦ Q 7 2 ♣ A 10 7 4		♠ A Q 9 6 4 ♥ 5 2 ♦ K 8 5 3 ♣ K 8	♠ 8 5 3 ♥ K 9 8 3 ♦ A 10 9 6 ♣ Q 9
		♠ K J 7 2 ♥ Q 10 ♦ J 4 ♣ J 6 5 3 2	

EW 4♥; NS 2♠; EW 3♦; EW 1N; EW 1♣; Par -300; NS 4♠×-2

West	North	East	South
<i>stewball</i>	<i>smispi</i>	<i>mohsen k</i>	<i>jec</i>
		Pass	Pass
1 ♥	1 ♠	2 ♥	3 ♠
Pass	Pass	Pass	

3 ♠ by North

<i>Trick</i>	<i>Lead</i>	<i>2nd</i>	<i>3rd</i>	<i>4th</i>
1. E	♥ 3	10	<u>J</u>	2
2. W	♥ <u>A</u>	5	8	Q
3. W	♥ 6	♠ <u>4</u>	9	♦ 4
4. N	♦ 3	6	J	Q
5. W	♦ 2	5	9	♠ <u>2</u>
6. S	♣ 2	4	<u>K</u>	9
7. N	♦ 8	10	♠ <u>7</u>	7
8. S	♣ 3	<u>A</u>	8	Q
9. W	♣ 7	♠ <u>Q</u>	♥ K	5
10. N	♦ K	A	♠ <u>K</u>	♣ 10
11. S	♠ <u>J</u>	10	6	3

Made 3 — NS +140

**Board 1703**  
 West Deals  
 None Vul

♠ A		♠ K Q 8
♥ K 9 7 6 4 3		♥ J 2
♦ A K 6 3 2		♦ 7 5 4
♣ 4		♣ J 10 8 6 2
	<div style="display: inline-block; background-color: green; color: white; padding: 5px; border: 1px solid black;">           N            W     E            S         </div>	♠ J 9 7 6 4
		♥ A 10 8
		♦ 10 8
		♣ Q 9 3
		♠ 10 5 3 2
		♥ Q 5
		♦ Q J 9
		♣ A K 7 5

EW 6♥; E 3N; EW 5♦; W 2N; EW 1♠; Par -980

West	North	East	South
<i>stewball</i>	<i>smispi</i>	<i>mohsen k</i>	<i>jec</i>
1 ♥	Pass	2 ♥	Dbl
3 ♦	Pass	3 ♥	Pass
4 ♥	Pass	Pass	Pass

4 ♥ by West

<i>Trick</i>	<i>Lead</i>	<i>2nd</i>	<i>3rd</i>	<i>4th</i>
1. N	♠ K	4	3	<u>A</u>
2. W	<u>♦ A</u>	4	8	9
3. W	<u>♦ K</u>	5	10	J
4. W	<u>♦ 2</u>	7	<u>♥ 10</u>	Q
5. E	<u>♥ A</u>	5	3	2
6. E	♥ 8	Q	<u>K</u>	J
Made 6 — NS -480				

**Board 1704**  
 North Deals  
 E-W Vul

♠ 6	<div style="display: inline-block; background-color: green; color: white; padding: 10px; border: 1px solid black;">             N W     E S           </div>	♠ K 2
♥ A Q J 5 3		♥ 8 2
♦ K 8 5 4		♦ A J 10 9
♣ J 6 5		♣ K Q 10 7 4
♠ A J 9 8 7		♠ Q 10 5 4 3
♥ 9 4	♥ K 10 7 6	
♦ Q 7 6 3	♦ 2	
♣ 3 2	♣ A 9 8	

EW 4♥; EW 5♦; EW 4♣; EW 2N; NS 2♠; Par -500; NS 5♠×-3

West	North	East	South
<i>stewball</i>	<i>smispi</i>	<i>mohsen k</i>	<i>jec</i>
	Pass	1 ♣	1 ♠
2 ♥	4 ♠	Pass	Pass
Dbl	Pass	Pass	Pass

4 ♠× by South

<i>Trick</i>	<i>Lead</i>	<i>2nd</i>	<i>3rd</i>	<i>4th</i>
1. W	♠ 6	<u>A</u>	2	3
2. N	♥ 4	8	10	<u>J</u>
3. W	♣ 5	2	Q	<u>A</u>
4. S	♥ 6	<u>Q</u>	9	2
5. W	<u>♣ J</u>	3	4	9

Down 2 — NS -300

**Board 1709**  
 East Deals  
 N-S Vul

♠ A ♥ A K 7 2 ♦ Q 6 2 ♣ A Q J 9 3	<div style="background-color: green; color: white; padding: 5px; width: 40px; height: 40px; margin: 0 auto; display: flex; flex-direction: column; align-items: center; justify-content: center;"> <span>N</span> <span>W</span> <span>E</span> <span>S</span> </div>	♠ K J 8 6 4 3 ♥ 9 4 ♦ 10 9 ♣ K 8 6	♠ 9 7 2 ♥ Q 6 3 ♦ 8 7 5 4 3 ♣ 4 2
♠ Q 10 5 ♥ J 10 8 5 ♦ A K J ♣ 10 7 5			

NS 2♠; EW 2♥; EW 3♦; EW 3♣; Par -110

West	North	East	South
<i>leroumain</i>	<i>ronpa</i>	<i>abc36</i>	<i>jec</i>
		Pass	Pass
1 ♣	1 ♠	Pass	2 ♣
Dbl	2 ♠	Pass	Pass
Dbl	Pass	3 ♦	Pass
4 ♦	Pass	Pass	Pass

4 ♦ by East

<i>Trick</i>	<i>Lead</i>	<i>2nd</i>	<i>3rd</i>	<i>4th</i>
1. S	♠ 5	<u>A</u>	3	2
2. W	♥ 2	4	<u>Q</u>	5
3. E	♣ 4	5	Q	<u>K</u>
4. N	♥ 9	6	8	<u>A</u>
5. W	<u>♣ A</u>	6	2	10
6. W	<u>♣ J</u>	8	♠ 7	7
7. W	♥ K	<u>♦ 9</u>	3	10
8. N	♠ K	9	10	<u>♦ 2</u>
9. W	♦ 6	10	3	<u>J</u>
10. S	<u>♦ K</u>	Q	♠ 6	4
11. S	<u>♦ A</u>	♣ 3	♠ 4	5
12. S	♠ Q	♣ 9	8	<u>♦ 7</u>
13. E	♦ 8	♥ J	♥ 7	♠ J

Down 2 — NS +100



**Board 1710**  
 South Deals  
 E-W Vul

♠ A J 10 9 3 2	♠ 4	♠ K Q 8 5
♥ 6 3	♥ J 10 4 2	♥ A 9 8
♦ A	♦ K Q J 6	♦ 9 5 2
♣ Q 7 3 2	♣ A K 10 4	♣ 8 6 5

N
W
S
E

♠ 7 6
♥ K Q 7 5
♦ 10 8 7 4 3
♣ J 9

EW 3♠; NS 3♥; NS 4♦; EW 2N; NS 1♣; Par +130

West	North	East	South
<i>leroumain</i>	<i>ronpa</i>	<i>abc36</i>	<i>jec</i>
			Pass
1 ♠	Dbl	2 ♠	Dbl
3 ♠	4 ♣	4 ♠	Pass
Pass	Pass		

4 ♠ by West

<i>Trick</i>	<i>Lead</i>	<i>2nd</i>	<i>3rd</i>	<i>4th</i>
1. N	<u>♣ A</u>	5	J	7
2. N	<u>♦ K</u>	2	3	<u>A</u>
3. W	<u>♠ J</u>	4	<u>Q</u>	6
4. E	<u>♦ 5</u>	4	<u>♠ A</u>	J
5. W	<u>♠ 2</u>	<u>♦ Q</u>	<u>8</u>	7
6. E	<u>♦ 9</u>	10	<u>♠ 9</u>	6
7. W	<u>♥ 6</u>	2	8	<u>Q</u>
8. S	<u>♣ 9</u>	Q	<u>K</u>	6

Down 1 — NS +100

**Board 1715**

West Deals  
None Vul

	♠ 5		
	♥ A Q 8 6 5		
	♦ K 8 5 4 2		
	♣ J 3		
♠ A J 10 9 4 ♥ 10 7 ♦ A 6 ♣ A Q 7 2	<div style="background-color: #006400; color: white; padding: 10px; display: inline-block; text-align: center;">                     N W     E S                 </div>	♠ Q 8 7 3 2 ♥ K 9 4 2 ♦ J 9 7 ♣ 8	
	♠ K 6		
	♥ J 3		
	♦ Q 10 3		
	♣ K 10 9 6 5 4		

EW 5♠; E 3N; W 2N; EW 1♥; NS 1♦; S 1♣; Par -450

West	North	East	South
<i>leroumain</i>	<i>ronpa</i>	<i>abc36</i>	<i>jec</i>
1 ♠	2 ♠ <sup>1</sup>	3 ♠	4 ♦
4 ♠	Pass	Pass	Pass

1. ♥ and minor

4 ♠ by West

<i>Trick</i>	<i>Lead</i>	<i>2nd</i>	<i>3rd</i>	<i>4th</i>
1. N	♦ 2	7	10	<u>A</u>
2. W	♠ <u>A</u>	5	2	6
3. W	♥ 7	<u>A</u>	2	3
4. N	♦ 4	9	<u>Q</u>	6
5. S	♠ <u>K</u>	4	♣ 3	3
6. S	♥ J	-	-	-

Made 4 — NS -420

**Board 1719**

West Deals  
N-S Vul

♠ Q J 6	♠ 10 7 4 3 2	♠ 9 8
♥ Q 6	♥ 10 5 2	♥ A K 8
♦ 5 2	♦ Q 7	♦ A J 10 8 4 3
♣ A K 10 8 5 2	♣ Q J 6	♣ 7 4

♠ A K 5
♥ J 9 7 4 3
♦ K 9 6
♣ 9 3

EW 4N; EW 4♦; EW 4♣; EW 1♠; EW 1♥; Par -430

West	North	East	South
<i>leroumain</i>	<i>ronpa</i>	<i>abc36</i>	<i>jec</i>
1 ♣	Pass	1 ♦	1 ♥
2 ♣	Pass	3 NT	Pass
Pass	Pass		

3 NT by East

<i>Trick</i>	<i>Lead</i>	<i>2nd</i>	<i>3rd</i>	<i>4th</i>
1. S	<u>♠ K</u>	6	7	8
2. S	<u>♠ A</u>	J	3	9
3. S	<u>♠ 5</u>	<u>Q</u>	4	♦ 3
4. W	<u>♣ A</u>	6	7	3
5. W	<u>♣ K</u>	J	4	9
6. W	<u>♣ 2</u>	<u>Q</u>	♦ 4	♦ 9
7. N	<u>♠ 2</u>	♦ 8	♥ 3	♦ 2
8. N	<u>♠ 10</u>	♦ 10	♥ 4	♦ 5
9. N	♦ Q	-	-	-

Down 1 — NS +50

**Board 1720**  
 North Deals  
 Both Vul

♠ 7 4 ♥ A Q J 3 ♦ A K 8 7 6 ♣ J 9		♠ J 2 ♥ K 9 4 2 ♦ 9 2 ♣ A Q 10 4 3	♠ Q 10 6 3 ♥ 10 ♦ J 10 3 ♣ K 8 7 6 5
♠ A K 9 8 5 ♥ 8 7 6 5 ♦ Q 5 4 ♣ 2			

E 2N; S 2♥; W 1N; EW 2♦; E 1♠; N 1♥; EW 1♣; Par -120

West	North	East	South
<i>leroumain</i>	<i>ronpa</i>	<i>abc36</i>	<i>jec</i>
	Pass	Pass	Pass
1 NT	Pass	Pass	2 ♣ <sup>1</sup>
Pass	2 ♥	2 NT	Pass
3 ♦	3 ♥	Pass	Pass
Pass			

1. MM

3 ♥ by North

Trick	Lead	2nd	3rd	4th
1. E	♦ J	4	8	2
2. E	♦ 10	5	<u>K</u>	9
3. W	♥ J	<u>K</u>	10	5
4. N	♣ A	5	2	9
5. N	♣ 3	6	♥ 6	J
6. S	♦ Q	A	♥ 2	3
7. N	♠ 2	6	<u>K</u>	4
8. S	♠ A	7	J	3
9. S	♠ 5	♥ 3	♥ 4	10
10. N	♣ 4	7	♥ 7	♥ Q
11. W	♥ A	9	♣ 8	8
12. W	♦ 7	♣ 10	♠ Q	♠ 8
13. W	♦ 6	♣ Q	♣ K	♠ 9

Down 2 — NS -200

**Board 1721**  
 East Deals  
 None Vul

♠ 8 4	♠ A 9 5 2	♠ Q 10 3
♥ K J 10 4	♥ Q 8 5	♥ A 6 2
♦ J 10 4	♦ 8 2	♦ 9 7 6
♣ Q 10 3 2	♣ 9 8 7 4	♣ A K J 5

♠ K J 7 6
♥ 9 7 3
♦ A K Q 5 3
♣ 6

NS 3♠; NS 2♦; EW 2♣; EW 1♥; Par +140

West	North	East	South
<i>leroumain</i>	<i>ronpa</i>	<i>abc36</i>	<i>jec</i>
		1 ♣	1 ♦
Pass	Pass	Pass	

1 ♦ by South

<i>Trick</i>	<i>Lead</i>	<i>2nd</i>	<i>3rd</i>	<i>4th</i>
1. W	♠ 8	9	Q	<u>K</u>
2. S	♦ <u>A</u>	4	2	6
3. S	♦ <u>K</u>	10	8	7
4. S	♦ <u>Q</u>	J	♣ 4	9
5. S	♠ 6	4	<u>A</u>	3
6. N	♠ 2	10	<u>J</u>	♣ 10
7. S	♠ <u>7</u>	♥ 4	5	♥ 2

Made 3 — NS +110

**Board 1730**  
 South Deals  
 Both Vul

♠ 9 4	♠ A J 10 7 3	♠ 8 5
♥ A 9	♥ 10 8 4 3	♥ K Q 7 6 5 2
♦ K J 7 4	♦ Q 10 3	♦ 9 8 2
♣ A 10 5 4 3	♣ 9	♣ K Q

N	
W	E
S	

♠ K Q 6 2
♥ J
♦ A 6 5
♣ J 8 7 6 2

NS 4♠; EW 2♥; EW 1N; EW 1♦; EW 1♣; Par +620

West	North	East	South
<i>leroumain</i>	<i>ronpa</i>	<i>abc36</i>	<i>jec</i>
			Pass
1 ♦	1 ♠	2 ♥	3 ♥
Pass	3 ♠	Pass	Pass
Dbl	Pass	4 ♦	Pass
Pass	Pass		

4 ♦ by West

Trick	Lead	2nd	3rd	4th
1. N	♣ 9	<u>Q</u>	2	3
2. E	♣ K	6	4	<u>♦ 3</u>
3. N	<u>♠ A</u>	5	K	4
4. N	♠ 3	8	<u>Q</u>	9
5. S	♣ 7	5	<u>♦ 10</u>	♥ 2
6. N	♥ 3	<u>K</u>	J	9
7. E	♦ 2	5	7	<u>Q</u>
8. N	♥ 4	5	<u>♦ 6</u>	A
9. S	♣ J	10	♠ 7	<u>♦ 8</u>
10. E	♦ 9	<u>A</u>	4	♥ 8

Down 4 — NS +400

**Board 1731**  
 West Deals  
 None Vul

♠ 10 ♥ Q J 9 ♦ 6 5 3 ♣ A J 9 8 5 3	♠ 9 7 3 2 ♥ A 5 3 ♦ A J 10 8 ♣ Q 7		♠ K J 8 6 5 ♥ 6 4 ♦ K 4 ♣ 10 6 4 2
♠ A Q 4 ♥ K 10 8 7 2 ♦ Q 9 7 2 ♣ K			

NS 4♥; NS 3♦; NS 1N; EW 2♣; NS 1♠; Par +420

West	North	East	South
<i>leroumain</i>	<i>ronpa</i>	<i>abc36</i>	<i>jec</i>
Pass	Pass	1 ♠	2 ♥
Pass	2 ♠	Pass	3 ♦
Pass	4 ♥	Pass	Pass
Dbl	Pass	Pass	Pass

4♥× by South

<i>Trick</i>	<i>Lead</i>	<i>2nd</i>	<i>3rd</i>	<i>4th</i>
1. W	♠ 10	2	6	<u>Q</u>
2. S	♥ <u>K</u>	9	3	4
3. S	♥ 2	J	<u>A</u>	6
4. N	♣ 7	4	K	<u>A</u>
5. W	♥ <u>Q</u>	5	♠ 5	7
6. W	♣ 3	<u>Q</u>	2	♠ 4
7. N	♠ 3	8	<u>A</u>	♣ 5
8. S	♦ 9	3	8	<u>K</u>
9. E	♠ K	-	-	-

Made 4 — NS +590

**Board 1733**  
 East Deals  
 Both Vul

♠ 9 7 6 2 ♥ 7 6 3 2 ♦ J 6 2 ♣ K 10		♠ A Q 3 ♥ A Q 5 4 ♦ 8 ♣ A J 8 4 2	♠ 10 4 ♥ K J ♦ A K 10 4 3 ♣ Q 9 6 5
		♠ K J 8 5 ♥ 10 9 8 ♦ Q 9 7 5 ♣ 7 3	

N 3♠; NS 3♥; NS 2N; S 2♠; NS 2♣; EW 1♦; Par +140

West	North	East	South
<i>leroumain</i>	<i>ronpa</i>	<i>abc36</i>	<i>jec</i>
		1♦	Pass
1♥	Dbl	2♦	2♠
Pass	3♠	Pass	Pass
Pass			

3♠ by South

<i>Trick</i>	<i>Lead</i>	<i>2nd</i>	<i>3rd</i>	<i>4th</i>
1. W	♦ 2	8	<u>K</u>	5
2. E	♠ 4	5	6	<u>Q</u>
3. N	♣ 2	6	7	<u>10</u>
4. W	♠ 2	<u>A</u>	10	8
5. N	<u>♣ A</u>	5	3	K
6. N	♣ 4	9	<u>♠ J</u>	♥ 3
7. S	♥ 8	2	4	<u>J</u>
8. E	♦ A	7	6	<u>♠ 3</u>
9. N	♣ 8	<u>Q</u>	♦ 9	♦ J
10. E	♦ 3	Q	<u>♠ 7</u>	♥ 5
11. W	♥ 6	Q	<u>K</u>	10
12. E	♦ 4	<u>♠ K</u>	♥ 7	♣ J
13. S	♥ 9	<u>♠ 9</u>	A	♦ 10

Down 3 — NS -300



**Board 1735**  
 West Deals  
 N-S Vul

♠ 10 9 2	♠ 8 7 6 5 3	♠ Q 4
♥ 7 4	♥ 10 3 2	♥ K J 9 8 5
♦ K 9 5 3	♦ 4	♦ A Q 10 8 7
♣ K 10 9 8	♣ A Q 6 3	♣ 5

N	
W	E
S	

♠ A K J
♥ A Q 6
♦ J 6 2
♣ J 7 4 2

NS 4♠; NS 4♣; NS 2N; EW 2♦; Par +500; EW 5♦×-3

West	North	East	South
<i>leroumain</i>	<i>ronpa</i>	<i>abc36</i>	<i>jec</i>
Pass	Pass	1 ♥	1 NT
Pass	2 ♥	3 ♦	3 ♠
4 ♦	4 ♠	5 ♦	Pass
Pass	Dbl	Pass	Pass
Pass			

5♦× by East

Trick	Lead	2nd	3rd	4th
1. S	<u>♠ A</u>	2	3	4
2. S	<u>♠ K</u>	9	5	Q
3. S	♠ J	10	6	<u>♦ 10</u>
4. E	♣ 5	4	K	<u>A</u>
5. N	♣ 3	<u>♦ 7</u>	2	8
6. E	♥ K	<u>A</u>	4	2
7. S	♣ J	9	6	<u>♦ 8</u>
8. E	♥ J	Q	7	3
9. S	♣ 7	10	Q	<u>♦ Q</u>
10. E	<u>♦ A</u>	2	3	4
11. E	♥ 8	6	<u>♦ 9</u>	10
12. W	<u>♦ K</u>	♠ 7	♥ 5	6
13. W	♦ 5	♠ 8	♥ 9	J

Down 4 — NS +800

**Board 1739**  
West Deals  
Both Vul

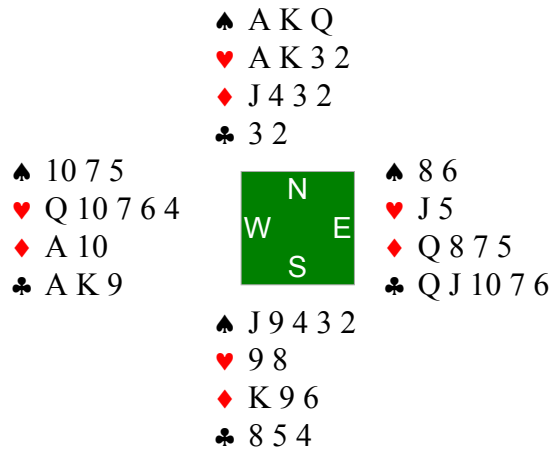

NS 2♠; EW 2♥; EW 1N; EW 2♣; NS 1♦; Par +110

West	North	East	South
<i>langya</i>	<i>miamiwiz</i>	<i>antech</i>	<i>jec</i>
1 ♥	1 NT	Pass	2 ♥
Pass	2 ♠	Pass	Pass

Pass

2 ♠ by North

<i>Trick</i>	<i>Lead</i>	<i>2nd</i>	<i>3rd</i>	<i>4th</i>
1. E	♣ Q	4	<u>K</u>	2
2. W	♥ 4	<u>A</u>	5	8
3. N	♣ 3	<u>10</u>	5	9
4. E	♥ J	9	6	<u>K</u>
5. N	♠ A	6	2	7
6. N	♠ K	8	3	5
7. N	♥ 2	♣ 6	♠ 4	7
8. S	♣ 8	A	♠ Q	7
9. N	♦ 3	7	K	<u>A</u>
10. W	♦ 10	J	<u>Q</u>	6
11. E	♦ 5	9	♠ 10	2
12. W	♥ 10	-	-	-

Made 2 — NS +110

**Board 1747**  
 West Deals  
 N-S Vul

♠ K	♠ A Q 8 7 6	♠ 10 5 4 2
♥ A 9	♥ Q 5 3	♥ K 10 8 7
♦ 10 8 6	♦ K 9 3 2	♦ Q 5 4
♣ A Q 6 5 4 3 2	♣ 10	♣ J 7

N	
W	E
S	

♠ J 9 3
♥ J 6 4 2
♦ A J 7
♣ K 9 8

NS 3N; NS 3♠; NS 2♥; NS 3♦; EW 2♣; Par +300; EW 4♣×-2

West	North	East	South
<i>langya</i>	<i>miamiwiz</i>	<i>antech</i>	<i>jec</i>
1 ♣	1 ♠	Dbl	2 ♠
3 ♣	Pass	Pass	Pass

3 ♣ by West

Trick	Lead	2nd	3rd	4th
1. N	♣ 10	7	8	<u>Q</u>
2. W	♣ A	♠ 8	J	9
3. W	♣ 4	♦ 9	♥ 7	<u>K</u>
4. S	♦ 7	10	<u>K</u>	4
5. N	♠ A	2	3	K
6. N	♦ 3	Q	<u>A</u>	8
7. S	♦ J	6	2	5
8. S	♠ 9	-	-	-

Down 1 — NS +50

**Board 1749**  
 East Deals  
 None Vul

♠ 4	♠ 8 7	♠ A Q J 9 5
♥ A 7 2	♥ K Q J	♥ 9 6 5 4 3
♦ K Q 8 4 3 2	♦ A J 10	♦ 9
♣ Q J 2	♣ A K 7 5 3	♣ 8 6

W	N	E
S		

♠ K 10 6 3 2
♥ 10 8
♦ 7 6 5
♣ 10 9 4

NS 3♣; NS 1N; NS 1♠; EW 1♥; Par +110

West	North	East	South
<i>langya</i>	<i>miamiwiz</i>	<i>antech</i>	<i>jec</i>
		Pass	Pass
1♦	1NT	2♠	Pass
Pass	Dbl <sup>1</sup>	Pass	Pass
Pass			

1. to

2♠× by East

Trick	Lead	2nd	3rd	4th
1. S	♥ 10	<u>A</u>	K	3
2. W	♦ K	<u>A</u>	9	5
3. N	♠ 8	J	<u>K</u>	4
4. S	♥ 8	2	<u>J</u>	4
5. N	♣ <u>K</u>	6	4	2
6. N	♣ <u>A</u>	8	9	J
7. N	♥ <u>Q</u>	5	♣ 10	7
8. N	♣ 3	♥ 6	<u>♠ 2</u>	Q
9. S	♦ 7	2	J	<u>♠ 5</u>
10. E	♠ <u>A</u>	3	♦ 3	7
11. E	♠ <u>Q</u>	6	♦ 4	♣ 5
12. E	♥ <u>9</u>	♦ 6	♦ 8	♣ 7
13. E	♠ 9	<u>10</u>	♦ Q	♦ 10

Down 3 — NS +500

**Board 1751**  
 West Deals  
 E-W Vul

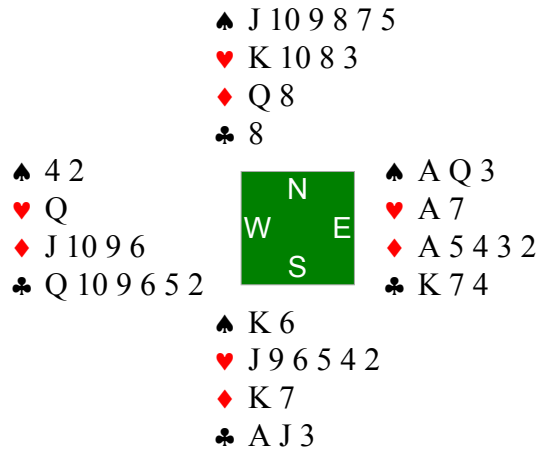

NS 4♥; E 5♣; W 4♣; NS 2♠; EW 3♦; Par -100: NS 5♥×-1

West	North	East	South
<i>langya</i>	<i>miamiwiz</i>	<i>antech</i>	<i>jec</i>
Pass	Pass	1 NT	2♦ <sup>1</sup>
Pass	3♥	Pass	4♥
Pass	Pass	Pass	

1. h

4♥ by North

<i>Trick</i>	<i>Lead</i>	<i>2nd</i>	<i>3rd</i>	<i>4th</i>
1. E	♦ <u>A</u>	7	6	8
2. E	♣ 4	<u>A</u>	9	8
3. S	♥ 2	Q	K	<u>A</u>
4. E	♠ <u>A</u>	6	4	8
5. E	♣ K	-	-	-

Made 4 — NS +420

**Board 1753**  
 East Deals  
 N-S Vul

♠ K Q J 6	♠ 5 3	♠ 7 4 2
♥ J	♥ A 4 3	♥ Q 10 5
♦ A 8 6 4	♦ J 3	♦ K Q 9 7 2
♣ A 8 3 2	♣ Q J 10 9 5 4	♣ 7 6

♠ A 10 9 8
♥ K 9 8 7 6 2
♦ 10 5
♣ K

EW 4♦; EW 2♠; NS 2♥; EW 1N; NS 1♣; Par -130

West	North	East	South
<i>langya</i>	<i>miamiwiz</i>	<i>antech</i>	<i>jec</i>
		Pass	Pass
1♦	Pass	1NT	Dbl
Rdbl	2♣	2♦	2♥
Pass	Pass	3♦	Pass
Pass	3♥	Pass	Pass

3♥ by South

Trick	Lead	2nd	3rd	4th
1. W	♠ K	3	2	8
2. W	♦ A	3	9	5
3. W	♦ 8	J	Q	10
4. E	♣ 7	K	A	4
5. W	♠ Q	5	4	A
6. S	♥ K	J	3	5
7. S	♥ 2	♣ 2	A	10
8. N	♣ Q	6	♠ 9	3
9. N	♣ J	♦ 2	♠ 10	8

Down 1 — NS -100

**Board 1757**  
 East Deals  
 E-W Vul

♠ 9 ♥ K Q 2 ♦ J 9 8 3 2 ♣ K J 10 7	♠ Q J 6 ♥ J 6 3 ♦ K 4 ♣ 9 6 5 4 2		♠ A K 10 8 ♥ 10 9 8 ♦ A 10 7 6 5 ♣ 3
	♠ 7 5 4 3 2 ♥ A 7 5 4 ♦ Q ♣ A Q 8		

EW 3N; EW 3♥; EW 4♦; EW 2♠; EW 2♣; Par -600

West	North	East	South
<i>langya</i>	<i>miamiwiz</i>	<i>antech</i>	<i>jec</i>
		1 ♦	1 ♠
2 ♠	Dbl	3 NT	Pass
Pass	Pass		

3 NT by East

<i>Trick</i>	<i>Lead</i>	<i>2nd</i>	<i>3rd</i>	<i>4th</i>
1. S	♣ Q	<u>K</u>	9	3
2. W	♦ 9	4	7	<u>Q</u>
3. S	♥ <u>A</u>	2	3	8
4. S	♣ <u>A</u>	7	6	♠ 8

Made 4 — NS -630

**Board 1759**

West Deals  
None Vul

♠ J 8 7 6 3	♠ 10 4	♠ A K 9 5 2
♥ J 9 4	♥ A Q 6 3 2	♥ K 8 7 5
♦ K	♦ 9 7 5	♦ 10 2
♣ A J 10 7	♣ 9 5 3	♣ K 6

♠ Q
♥ 10
♦ A Q J 8 6 4 3
♣ Q 8 4 2

EW 4♠; EW 3♥; NS 2♦; EW 1♣; Par -420

West	North	East	South
<i>langya</i>	<i>miamiwiz</i>	<i>antech</i>	<i>jec</i>
Pass	Pass	1 ♠	3 ♦
4 ♦	Pass	4 ♠	Pass
Pass	Pass		

4 ♠ by East

<i>Trick</i>	<i>Lead</i>	<i>2nd</i>	<i>3rd</i>	<i>4th</i>
1. S	♥ 10	4	<u>A</u>	5
2. N	♥ 6	7	<u>♠ Q</u>	9
3. S	<u>♦ A</u>	K	5	2
4. S	♦ Q	<u>♠ J</u>	7	10

Made 4 — NS -420



**Board 1762**  
 South Deals  
 None Vul

♠ Q 5 ♥ K Q 10 3 ♦ K Q 6 3 ♣ K 10 5		♠ 9 6 ♥ A 7 6 ♦ A 9 4 2 ♣ J 8 6 3	♠ K 10 8 4 ♥ J 9 4 ♦ 8 7 5 ♣ Q 4 2
♠ A J 7 3 2 ♥ 8 5 2 ♦ J 10 ♣ A 9 7			

EW 1N; EW 1♥; EW 1♦; NS 1♣; Par -90

West	North	East	South
<i>langya</i>	<i>miamiwiz</i>	<i>antech</i>	<i>jec</i>
			Pass
1 NT	Pass	Pass	2♥ <sup>1</sup>
Pass	2♠	Pass	Pass
Pass			

1. s

2♠ by North

<i>Trick</i>	<i>Lead</i>	<i>2nd</i>	<i>3rd</i>	<i>4th</i>
1. E	♣ 2	7	<u>K</u>	6
2. W	<u>♥ K</u>	6	9	2
3. W	♦ K	<u>A</u>	5	10
4. N	♦ 2	7	J	<u>Q</u>
5. W	♥ 3	<u>A</u>	4	5
6. N	<u>♦ 9</u>	8	♥ 8	3
7. N	♥ 7	J	<u>♠ 2</u>	Q
8. S	♠ 3	<u>Q</u>	6	4
9. W	♣ 5	3	Q	<u>A</u>
10. S	♣ 9	10	<u>J</u>	4
11. N	♠ 9	10	<u>J</u>	5
12. S	<u>♠ A</u>	♦ 6	♦ 4	8
13. S	♠ 7	♥ 10	♣ 8	<u>K</u>

Made 2 — NS +110

**Board 1763**  
 West Deals  
 N-S Vul

♠ K 3		♠ 7
♥ A Q 4 3		♥ 8
♦ A Q 8 6 5 2		♦ 9 7 4 3
♣ 5		♣ K Q 9 7 6 3 2
	<div style="display: inline-block; background-color: green; color: white; padding: 5px; border: 1px solid black;">           N            W     E            S         </div>	♠ A 9 8 4
		♥ J 10 7 6 5
		♦ K
		♣ J 8 4
		♠ Q J 10 6 5 2
		♥ K 9 2
		♦ J 10
		♣ A 10

EW 6♥; EW 5♦; EW 2♠; NS 1♣; Par -980

West	North	East	South
<i>langya</i>	<i>miamiwiz</i>	<i>antech</i>	<i>jec</i>
1 ♦	Pass	1 ♥	1 ♠
2 ♠	Pass	4 ♥	Pass
Pass	Pass		

4 ♥ by East

<i>Trick</i>	<i>Lead</i>	<i>2nd</i>	<i>3rd</i>	<i>4th</i>
1. S	♠ Q	<u>K</u>	7	4
2. W	♥ A	8	6	2
3. W	♥ 3	♣ 9	10	<u>K</u>
4. S	♣ A	5	3	4
5. S	♣ 10	♥ 4	6	8
6. W	♦ 2	7	<u>K</u>	J
7. E	♥ 5	9	<u>Q</u>	♣ 2
8. W	♦ A	3	♣ J	10
9. W	♦ Q	4	♠ 8	♠ 2

Made 4 — NS -420

**Board 1764**  
 North Deals  
 None Vul

♠ A Q 2	<div style="display: inline-block; background-color: green; color: white; padding: 10px; border: 1px solid black;">           N W     E S         </div>	♠ K 7 6 4
♥ K 7		♥ J 9 3
♦ A Q 7 5 2		♦ J 8
♣ 6 4 3		♣ A K 8 5
♠ J 3		♥ A Q 5
		♦ K 10 6 4 3
		♣ Q 10 9

EW 4N; EW 4♠; EW 4♦; EW 4♣; EW 1♥; Par -430

West	North	East	South
<i>stewball</i>	<i>smispi</i>	<i>Harmon</i>	<i>jec</i>
	Pass	1 ♣	1 ♦
3 NT	Pass	Pass	Pass

3 NT by West

<i>Trick</i>	<i>Lead</i>	<i>2nd</i>	<i>3rd</i>	<i>4th</i>
1. N	♦ 9	J	K	<u>A</u>
2. W	♣ 4	2	<u>A</u>	10
3. E	♦ 8	10	<u>Q</u>	♥ 2
4. W	♣ 3	7	8	<u>9</u>
5. S	♠ J	<u>Q</u>	5	4
6. W	♠ 2	8	<u>K</u>	3
7. E	♠ 6	♥ 5	<u>A</u>	9
8. W	♣ 6	J	<u>K</u>	Q
9. E	<u>♣ 5</u>	♦ 3	♦ 2	♥ 4
10. E	♠ 7	♦ 4	♦ 5	<u>10</u>
11. N	♥ 6	-	-	-

Made 4 — NS -430

**Board 1765**  
 East Deals  
 N-S Vul

♠ 8 ♥ 10 6 3 ♦ Q J 10 6 5 3 ♣ 8 3 2		♠ Q 7 2 ♥ K Q J 8 5 ♦ K 9 7 ♣ J 5	♠ A 10 9 6 3 ♥ — ♦ A 8 4 2 ♣ A 10 9 7
♠ K J 5 4 ♥ A 9 7 4 2 ♦ — ♣ K Q 6 4			

NS 3♥; EW 4♦; NS 2♠; Par -130

West	North	East	South
<i>stewball</i>	<i>smispi</i>	<i>Harmon</i>	<i>jec</i>
		1 ♠	Pass
1 NT	Pass	2 ♣	Pass
2 ♦	2 ♥	3 ♦	4 ♥
Pass	Pass	5 ♦	Dbl
Pass	Pass	Pass	

5 ♦ × by West

<i>Trick</i>	<i>Lead</i>	<i>2nd</i>	<i>3rd</i>	<i>4th</i>
1. N	♥ K	<u>♦ 2</u>	7	3
2. E	♠ A	4	8	2
3. E	♠ 3	5	<u>♦ 3</u>	7
4. W	♥ 6	8	<u>♦ 4</u>	2
5. E	♠ 6	K	<u>♦ 5</u>	Q
6. W	♥ 10	J	<u>♦ 8</u>	4
7. E	<u>♦ A</u>	♣ 6	6	7
8. E	♠ 9	J	<u>♦ 10</u>	♣ 5
9. W	♣ 2	J	<u>A</u>	4
10. E	♠ 10	♥ 9	♣ 3	<u>♦ 9</u>

Down 1 — NS +100

**Board 1776**  
 North Deals  
 Both Vul

	♠ 7 2		
	♥ 10 3 2		
	♦ 9 3		
	♣ K J 10 9 8 2		
♠ A J 10 9 6 4	<div style="display: inline-block; background-color: green; color: white; padding: 5px; text-align: center;">       N        W     E        S     </div>	♠ Q 8 5 3	
♥ 5		♥ A K J 9 8	
♦ 6 4		♦ A J 10 7	
♣ A 7 6 5		♣ —	
	♠ K		
	♥ Q 7 6 4		
	♦ K Q 8 5 2		
	♣ Q 4 3		

EW 7♠; EW 5N; EW 5♥; EW 3♦; Par -2210

West	North	East	South
<i>stewball</i>	<i>smispi</i>	<i>Harmon</i>	<i>jec</i>
	Pass	1 ♥	Pass
1 ♠	Pass	4 ♣	Pass
5 ♣	Pass	5 ♦	Dbl
Pass	Pass	5 NT	Pass
6 ♠	Pass	Pass	Pass

6 ♠ by West

Trick	Lead	2nd	3rd	4th
1. N	♦ 9	<u>A</u>	2	4
2. E	♥ A	4	5	3
3. E	♥ <u>K</u>	6	♦ 6	2
4. E	♥ 8	7	<u>♠ 4</u>	10
5. W	<u>♣ A</u>	2	♦ 7	3
6. W	♣ 5	8	<u>♠ 3</u>	4
7. E	♠ 5	K	<u>A</u>	2
8. W	♣ 6	9	<u>♠ 8</u>	Q
9. E	♦ 10	K	<u>♠ 9</u>	3
10. W	♣ 7	J	<u>♠ Q</u>	♦ 5
11. E	♥ 9	Q	-	-

Made 7 — NS -1460

**Board 1777**  
 East Deals  
 None Vul

♠ 9 5 4 2 ♥ 5 ♦ A 9 7 2 ♣ 10 9 3 2		♠ K Q J 8 ♥ K 3 2 ♦ K ♣ A Q J 8 4	♠ A ♥ A Q 10 8 6 ♦ Q 10 8 4 ♣ K 7 5
		♠ 10 7 6 3 ♥ J 9 7 4 ♦ J 6 5 3 ♣ 6	

EW 3♦; EW 1N; NS 1♠; EW 1♥; EW 1♣; Par -110

West	North	East	South
<i>stewball</i>	<i>smispi</i>	<i>Harmon</i>	<i>jec</i>
		1♥	Pass
Pass	Dbl	Pass	1♠
Pass	2♥	Pass	2♠
Pass	Pass	Pass	

2♠ by South

<i>Trick</i>	<i>Lead</i>	<i>2nd</i>	<i>3rd</i>	<i>4th</i>
1. W	♥ 5	2	<u>Q</u>	4
2. E	♦ 4	3	<u>A</u>	K
3. W	♠ 2	J	<u>A</u>	3
4. E	♦ 8	<u>J</u>	2	♣ 4
5. S	♠ 6	4	<u>Q</u>	♥ 6
6. N	<u>♣ A</u>	5	6	2
7. N	♣ Q	K	<u>♠ 7</u>	3
8. S	♦ 5	7	<u>♠ 8</u>	10
9. N	<u>♣ J</u>	7	♥ 7	10
10. N	♣ 8	♥ 8	<u>♠ 10</u>	9

Made 2 — NS +110

**Board 1779**  
 West Deals  
 E-W Vul

♠ Q 10 9 8 3		♠ A K 7 5 2
♥ 7		♥ 5 3
♦ J 9 5 4 2		♦ K Q 3
♣ K 2		♣ A 9 5

♠ 6 4
♥ A K 10 8 6
♦ A 8 6
♣ Q 10 8

EW 5♠; NS 3♥; EW 4♦; EW 1N; NS 2♣; Par -500: NS 6♥×-3

West	North	East	South
<i>stewball</i>	<i>smispi</i>	<i>Harmon</i>	<i>jec</i>
Pass	Pass	1 ♠	2 ♥
4 ♠	5 ♥	Dbl	Pass
Pass	Pass		

5 ♥× by South

<i>Trick</i>	<i>Lead</i>	<i>2nd</i>	<i>3rd</i>	<i>4th</i>
1. W	♠ 3	J	<u>K</u>	4
2. E	♦ K	<u>A</u>	2	7
3. S	♥ <u>A</u>	7	2	3
4. S	♥ 6	♠ 10	<u>Q</u>	5
5. N	♣ 3	<u>A</u>	8	2
6. E	♦ <u>Q</u>	8	4	10
7. E	♦ 3	6	9	<u>♥ 4</u>

Down 2 — NS -300

**Board 1780**  
 North Deals  
 None Vul

♠ J 10 6 4 ♥ 10 9 5 ♦ 6 ♣ A K 8 5 3	♠ A Q 5 ♥ Q J 7 ♦ 9 7 5 4 2 ♣ Q 4	<div style="text-align: center; border: 1px solid black; width: 40px; height: 40px; margin: 0 auto; background-color: green; color: white; display: flex; flex-direction: column; align-items: center; justify-content: center;"> <span>N</span> <span>W</span> <span>E</span> <span>S</span> </div>	♠ K 7 3 ♥ A 8 2 ♦ K 3 ♣ J 10 7 6 2
♠ 9 8 2 ♥ K 6 4 3 ♦ A Q J 10 8 ♣ 9			

NS 4♦; NS 2♥; EW 2♣; EW 1♠; Par +130

West	North	East	South
<i>stewball</i>	<i>smispi</i>	<i>Harmon</i>	<i>jec</i>
	Pass	1 ♣	1 ♦
Dbl	Rdbl	Pass	Pass
3 ♣	3 ♦	4 ♣	Pass
Pass	4 ♦	Pass	Pass
Pass			

4 ♦ by South

<i>Trick</i>	<i>Lead</i>	<i>2nd</i>	<i>3rd</i>	<i>4th</i>
1. W	<u>♣ A</u>	4	J	9
2. W	<u>♠ J</u>	Q	<u>K</u>	2
3. E	<u>♠ 7</u>	9	10	<u>A</u>
4. N	<u>♦ 9</u>	3	8	6
5. N	<u>♦ 2</u>	K	<u>A</u>	♣ 5

Made 4 — NS +130



**Board 1785**

East Deals  
N-S Vul

♠ 3		♠ J 9 7
♥ Q J 10 9 7 6		♥ K 5 3 2
♦ 4 3 2		♦ A K 8 6 5
♣ 9 7 2		♣ 8
♠ K Q 10 8 6 4 2	<div style="display: inline-block; border: 1px solid black; background-color: #006400; color: white; padding: 5px; text-align: center;">             N W     E S           </div>	
♥ —		
♦ 10 9 7		
♣ A 5 4		
♠ A 5		
♥ A 8 4		
♦ Q J		
♣ K Q J 10 6 3		

EW 6♠; EW 5♦; NS 2♥; NS 2♣; Par -980

West	North	East	South
<i>stewball</i>	<i>smispi</i>	<i>ghionis</i>	<i>jec</i>
		1 ♦	Dbl
1 ♠	Pass	2 ♠	3 ♣
4 ♣	4 ♥	Dbl	Pass
5 ♥	Pass	6 ♠	Pass
Pass	Pass		

6 ♠ by West

Trick	Lead	2nd	3rd	4th
1. N	♣ 2	8	10	<u>A</u>
2. W	♣ 4	9	<u>♠ 7</u>	3
3. E	♥ 2	A	<u>♠ 2</u>	Q
4. W	♣ 5	7	<u>♠ 9</u>	6
5. E	♠ J	5	<u>K</u>	3
6. W	♠ Q	♥ 6	♦ 5	<u>A</u>
7. S	♣ K	-	-	-

Made 6 — NS -980

**Board 1787**  
 West Deals  
 Both Vul

♠ Q 9 5	<div style="display: inline-block; background-color: green; color: white; padding: 10px; border: 1px solid black;">           N W     E S         </div>	♠ K J 7 6 3
♥ A 7 6 4		♥ J 2
♦ Q 8 7		♦ 4
♣ 8 7 5		♣ A Q 9 4 2
♠ A 2		♠ 10 8 4
♥ 9 5 3	♥ K Q 10 8	
♦ 10 9 6 5 3 2	♦ A K J	
♣ J 6	♣ K 10 3	

EW 2♠; NS 2♥; NS 3♦; EW 2♣; Par +110

West	North	East	South
<i>stewball</i>	<i>smispi</i>	<i>ghionis</i>	<i>jec</i>
Pass	Pass	1 ♠	Dbl
2 ♠	Pass	3 ♠	Pass
Pass	Pass		

3 ♠ by East

<i>Trick</i>	<i>Lead</i>	<i>2nd</i>	<i>3rd</i>	<i>4th</i>
1. S	♦ <u>A</u>	7	5	4
2. S	♥ Q	<u>A</u>	3	2
3. W	♠ 5	2	<u>J</u>	8
4. E	♠ 3	4	Q	<u>A</u>
5. N	♥ 9	J	<u>K</u>	4
6. S	♥ 10	6	5	<u>♠ 6</u>
7. E	♣ <u>A</u>	3	5	6
8. E	♣ 2	10	7	<u>J</u>
9. N	♦ 3	<u>♠ 7</u>	J	8
10. E	♣ 9	<u>K</u>	8	♦ 2
11. S	♦ K	Q	6	<u>♠ K</u>
12. E	♣ 4	<u>♠ 10</u>	♥ 7	♦ 9
13. S	♥ 8	-	-	-

Down 2 — NS +200

**Board 1797**  
 West Deals  
 Both Vul

♠ A 10 9 3	♠ K 7 6 5	♠ 8
♥ J 9 8	♥ A 7 5	♥ 6
♦ K 9 3	♦ Q 7	♦ A J 10 8 6 2
♣ K 8 2	♣ Q 10 7 5	♣ A 9 6 4 3

♠ Q J 4 2
♥ K Q 10 4 3 2
♦ 5 4
♣ J

EW 5♦; EW 4♣; NS 2♠; NS 2♥; EW 1N; Par -600

West	North	East	South
<i>ghionis</i>	<i>llorenzo</i>	<i>alati</i>	<i>jec</i>
Pass	Pass	2♦ <sup>1</sup>	Pass
2NT	Pass	3♥ <sup>2</sup>	Dbl
Pass	Pass	4♣	Pass
4♦	Pass	Pass	Pass

1. weak♦

2. good points, not very good colour

4♦ by East

Trick	Lead	2nd	3rd	4th
1. S	♥K	8	7	6
2. S	♥2	9	A	♦2
3. E	♣3	J	♠K	5
4. W	♣2	7	A	♦4
5. S	♥Q	J	5	♦6
6. E	♣4	♦5	8	10
7. S	♠Q	♠A	7	8
8. W	♦3	7	♠A	♥3
9. E	♣6	♥4	♦9	Q
10. W	♦K	Q	-	-

Made 4 — NS -130

**Board 1804**  
 South Deals  
 None Vul

♠ 7 6 3 2 ♥ Q J 10 8 2 ♦ A K 8 ♣ 3	♠ Q J 10 9 ♥ A 5 ♦ Q J 9 6 3 ♣ A K		♠ A 8 5 ♥ 7 6 ♦ 4 ♣ J 8 7 6 5 4 2
♠ K 4 ♥ K 9 4 3 ♦ 10 7 5 2 ♣ Q 10 9			

S 2N; NS 3♦; N 1N; NS 1♠; EW 1♣; Par +120

West	North	East	South
<i>ghionis</i>	<i>llorenzo</i>	<i>alati</i>	<i>jec</i>
			Pass
1 ♥	Dbl	1 NT <sup>1</sup>	Dbl
2 ♣ <sup>2</sup>	2 ♥	3 ♣	Pass
Pass	3 NT	4 ♣	Pass
Pass	Dbl	Pass	Pass
Pass			

1. ♣

2. forced

4 ♣× by West

<i>Trick</i>	<i>Lead</i>	<i>2nd</i>	<i>3rd</i>	<i>4th</i>
1. N	♠ Q	<u>A</u>	4	2
2. E	♦ 4	10	<u>A</u>	3
3. W	<u>♦ K</u>	6	♠ 5	2
4. W	♣ 3	<u>K</u>	2	10
5. N	♠ J	8	<u>K</u>	3
6. S	♥ 4	Q	<u>A</u>	6
7. N	♥ 5	7	<u>K</u>	2
8. S	♥ 9	J	<u>♣ A</u>	♣ 4
9. N	♠ 10	♣ 5	<u>♣ 9</u>	6
10. S	<u>♣ Q</u>	♦ 8	♦ 9	6
11. S	♥ 3	-	-	-

Down 4 — NS +800

**Board 1809**

West Deals  
E-W Vul

♠ Q 8 7		♠ J 4 3
♥ A K Q 10		♥ J 7 5 4 3 2
♦ 10 4 3		♦ 5 2
♣ Q 10 2		♣ J 7
♠ A K 2		♠ 10 9 6 5
♥ 9	♥ 8 6	
♦ A K 8 7 6	♦ Q J 9	
♣ A K 9 4	♣ 8 6 5 3	

NS 4♠; NS 5♣; NS 4♦; NS 1N; EW 1♥; Par +420

West	North	East	South
<i>ghionis</i>	<i>llorenzo</i>	<i>alati</i>	<i>jec</i>
1 ♣	Dbl	Pass	1 ♠
Pass	2 ♣	Pass	2 ♠
Pass	3 ♦	Pass	4 ♦
Pass	4 ♠	Pass	Pass
Pass			

4 ♠ by South

<i>Trick</i>	<i>Lead</i>	<i>2nd</i>	<i>3rd</i>	<i>4th</i>
1. W	♥ <u>A</u>	9	3	8
2. W	♥ <u>K</u>	♠ <u>2</u>	4	6
3. N	♠ <u>A</u>	4	5	7
4. N	♠ <u>K</u>	3	6	8
5. N	♦ 6	2	<u>Q</u>	3
6. S	♠ 10	<u>Q</u>	♣ 4	J
7. W	♥ <u>Q</u>	♣ 9	5	<u>♠ 9</u>

Made 5 — NS +450

**Board 1815**  
 East Deals  
 E-W Vul

♠ 9 5 ♥ A 8 7 6 2 ♦ J 7 3 ♣ K 9 6		♠ A 10 4 2 ♥ J 3 ♦ 9 6 ♣ 10 8 5 4 2	♠ K J 7 6 3 ♥ K 5 ♦ A 10 8 2 ♣ Q 3
♠ Q 8 ♥ Q 10 9 4 ♦ K Q 5 4 ♣ A J 7			

E 1N; EW 1♠; EW 1♥; EW 1♦; NS 1♣; Par -90

West	North	East	South
<i>ghionis</i>	<i>llorenzo</i>	<i>alati</i>	<i>jec</i>
		1 ♠	Dbl
Rdbl	2 ♣	2 ♦	Pass
2 ♠	Pass	Pass	Pass

2 ♠ by East

<i>Trick</i>	<i>Lead</i>	<i>2nd</i>	<i>3rd</i>	<i>4th</i>
1. S	♥ 10	2	3	<u>K</u>
2. E	♣ 3	7	<u>K</u>	2
3. W	♥ <u>A</u>	J	5	4
4. W	♥ 6	♣ 4	♠ <u>3</u>	9
5. E	♣ Q	<u>A</u>	6	5
6. S	♣ J	9	8	♠ <u>6</u>
7. E	♦ <u>A</u>	4	3	6
8. E	♦ 2	<u>Q</u>	7	9
9. S	♦ <u>K</u>	J	♣ 10	10
10. S	♦ 5	♠ 9	♠ <u>10</u>	8
11. N	♠ 2	J	<u>Q</u>	5
12. S	♠ 8	♥ 7	<u>A</u>	7
13. N	♠ 4	<u>K</u>	♥ Q	♥ 8

Down 1 — NS +100

**Board 1819**  
 East Deals  
 Both Vul

	♠ A K 10 2		
	♥ 7		
	♦ 7 6 5 2		
	♣ A K J 7		
♠ 6 5 4 ♥ K Q 8 6 2 ♦ Q J ♣ Q 10 4	<div style="display: inline-block; background-color: green; color: white; padding: 5px; border: 1px solid black;">           N W     E S         </div>	♠ Q J 3 ♥ A J 9 4 ♦ K 10 9 4 ♣ 6 3	
	♠ 9 8 7		
	♥ 10 5 3		
	♦ A 8 3		
	♣ 9 8 5 2		

NS 2♠; EW 2♥; NS 3♣; NS 1N; NS 1♦; Par +110

West	North	East	South
<i>ghionis</i>	<i>llorenzo</i>	<i>alati</i>	<i>jec</i>
		Pass	Pass
1 ♥	Dbl	2 NT <sup>1</sup>	Pass
3 ♥	Pass	Pass	Pass

1. limit ♥

3 ♥ by West

<i>Trick</i>	<i>Lead</i>	<i>2nd</i>	<i>3rd</i>	<i>4th</i>
1. N	<u>♣ A</u>	3	5	4
2. N	<u>♠ K</u>	3	7	5
3. N	<u>♠ A</u>	J	9	6
4. N	♠ 2	<u>Q</u>	8	4
5. E	♥ 4	3	<u>K</u>	7
6. W	♥ 2	♠ 10	<u>A</u>	5
7. E	<u>♥ J</u>	10	6	♣ 7
8. E	♦ 4	3	<u>Q</u>	7
9. W	♦ J	2	K	<u>A</u>
10. S	♣ 9	Q	<u>K</u>	6
11. N	♣ J	-	-	-

Down 1 — NS +100

**Board 1826**  
 North Deals  
 N-S Vul

♠ J ♥ 8 3 2 ♦ K Q 5 3 2 ♣ K 9 6 4		♠ 10 9 8 4 ♥ Q J 10 6 5 4 ♦ — ♣ 7 3 2	♠ A K 6 5 2 ♥ K 7 ♦ J 10 9 4 ♣ J 10
		♠ Q 7 3 ♥ A 9 ♦ A 8 7 6 ♣ A Q 8 5	

NS 3♥; E 2N; EW 3♦; W 1N; NS 1♣; Par +100; E 3N×-1;  
 EW 4♦×-1

West	North	East	South
<i>luojiawei</i>	<i>BridgeGoth</i>	<i>fu_eric</i>	<i>jec</i>
	Pass	1 ♠	1 NT
Dbl <sup>1</sup>	Rdbl <sup>2</sup>	Pass	2 ♣ <sup>3</sup>
Pass	2 ♥	Pass	Pass
Pass			

1. cards,9+hcp
2. 1 suit
3. forced

2 ♥ by North

<i>Trick</i>	<i>Lead</i>	<i>2nd</i>	<i>3rd</i>	<i>4th</i>
1. E	♦ J	6	5	<u>♥ 4</u>
2. N	♥ 5	7	<u>9</u>	2
3. S	<u>♥ A</u>	3	6	K
4. S	♠ 3	<u>J</u>	4	2
5. W	♦ 2	<u>♥ 10</u>	4	7
6. N	<u>♥ Q</u>	♠ 5	♣ 5	8
7. N	♠ 8	<u>K</u>	7	♣ 6
8. E	♦ 10	<u>A</u>	3	♣ 2
9. S	♠ Q	♣ 4	9	<u>A</u>
10. E	♣ J	Q	<u>K</u>	3
11. W	♦ K	-	-	-

Made 3 — NS +140



**Board 1827**  
 East Deals  
 E-W Vul

♠ K Q 8 5 4	♠ 2	♠ 10 9 7 3
♥ 6	♥ Q 10 8 2	♥ K 7 5 4
♦ Q 10 8 2	♦ J 9 7 4 3	♦ A K 5
♣ K 10 3	♣ 6 5 2	♣ A 7

♠ A J 6
♥ A J 9 3
♦ 6
♣ Q J 9 8 4

E 5♠; W 4♠; E 3N; W 2N; EW 2♦; NS 1♥; NS 1♣; Par -650

West	North	East	South
<i>luojiawei</i>	<i>BridgeGoth</i>	<i>fu_eric</i>	<i>jec</i>
		1♦	Dbl
1♠	Pass	2♠	Pass
4♠	Pass	Pass	Pass

4♠ by West

<i>Trick</i>	<i>Lead</i>	<i>2nd</i>	<i>3rd</i>	<i>4th</i>
1. N	♥ 8	4	<u>A</u>	6
2. S	♥ 3	♣ 3	10	<u>K</u>
3. E	♠ 3	6	<u>K</u>	2
4. W	♣ 10	2	<u>A</u>	4
5. E	♠ 10	<u>A</u>	4	♣ 5
6. S	♥ J	<u>♠ 8</u>	2	5
7. W	♠ Q	♦ 3	-	-

Made 5 — NS -650

**Board 1829**

West Deals  
None Vul

	♠ K 9 5 4		
	♥ 6 4		
	♦ A Q 8 5 2		
	♣ 7 3		
♠ 10 8 2		♠ 7 6	
♥ J 7 5 3 2		♥ A K 9	
♦ J 10		♦ 7 6 3	
♣ K J 5		♣ A Q 10 9 6	
	♠ A Q J 3		
	♥ Q 10 8		
	♦ K 9 4		
	♣ 8 4 2		

NS 3♠; EW 2♥; NS 3♦; EW 2♣; Par +140

West	North	East	South
<i>luojiawei</i>	<i>BridgeGoth</i>	<i>fu_eric</i>	<i>jec</i>
Pass	Pass	1 ♣	Dbl
Pass	2 ♠	Pass	Pass
Pass			

2 ♠ by North

<i>Trick</i>	<i>Lead</i>	<i>2nd</i>	<i>3rd</i>	<i>4th</i>
1. E	♠ 7	3	10	<u>K</u>
2. N	♠ 4	6	<u>A</u>	2
3. S	<u>♠ Q</u>	8	5	♣ 9
4. S	♦ 9	10	<u>A</u>	3
5. N	♦ 2	7	<u>K</u>	J

Made 4 — NS +170

**Board 1833**

West Deals  
N-S Vul

♠ A J 7 5	♠ K	♠ Q 10 9 6 4
♥ Q 8 3	♥ J 6 2	♥ A K 7 4
♦ A K 10 6 5	♦ 7 4 3	♦ J 9 8
♣ 7	♣ A K J 9 4 3	♣ 8

♠ 8 3 2
♥ 10 9 5
♦ Q 2
♣ Q 10 6 5 2

EW 6♠; EW 6♥; EW 6♦; EW 1N; NS 1♣; Par -980

West	North	East	South
<i>luojiawei</i>	<i>BridgeGoth</i>	<i>fu_eric</i>	<i>jec</i>
1 ♦	2 ♣	Dbl	4 ♣
Dbl	Pass	Pass	Pass

4 ♣× by North

<i>Trick</i>	<i>Lead</i>	<i>2nd</i>	<i>3rd</i>	<i>4th</i>
1. E	<u>♥ A</u>	5	8	2
2. E	<u>♥ K</u>	9	3	6
3. E	♥ 7	10	<u>Q</u>	J
4. W	<u>♦ K</u>	3	8	2
5. W	<u>♦ A</u>	4	9	Q
6. W	<u>♠ A</u>	K	4	2

Down 3 — NS -800

**Board 1837**  
 West Deals  
 E-W Vul

♠ J 8 4 ♥ 8 4 ♦ Q 9 7 3 ♣ 10 7 5 4		♠ 10 5 ♥ J 5 3 2 ♦ A J 10 8 5 ♣ K 8	♠ A K 7 3 ♥ A Q 9 7 ♦ 6 2 ♣ 9 6 2
♠ Q 9 6 2 ♥ K 10 6 ♦ K 4 ♣ A Q J 3			

NS 3N; NS 3♥; NS 4♦; NS 2♠; NS 3♣; Par +400

West	North	East	South
<i>luojiawei</i>	<i>BridgeGoth</i>	<i>fu_eric</i>	<i>jec</i>
Pass	Pass	1 ♣	1 NT
Pass	2 ♣	Pass	2 ♠
Pass	3 NT	Pass	Pass

Pass

3 NT by South

<i>Trick</i>	<i>Lead</i>	<i>2nd</i>	<i>3rd</i>	<i>4th</i>
1. W	♣ 4	8	9	<u>Q</u>
2. S	<u>♦ K</u>	3	5	6
3. S	♦ 4	7	<u>J</u>	2
4. N	<u>♦ A</u>	♣ 2	♠ 2	9
5. N	♦ 10	♠ 3	♥ 6	<u>Q</u>
6. W	♥ 8	2	<u>A</u>	10
7. E	♥ 7	<u>K</u>	4	3
8. S	♣ 3	5	<u>K</u>	6
9. N	<u>♦ 8</u>	♠ 7	♠ 6	♠ 4
10. N	♠ 5	<u>K</u>	9	8
11. E	<u>♠ A</u>	Q	J	10
12. E	<u>♥ Q</u>	♣ J	♣ 7	5
13. E	♥ 9	♣ A	♣ 10	<u>J</u>

Down 1 — NS -50

**Board 1845**  
 West Deals  
 None Vul

♠ 4	♠ 5 3	♠ 9 8 7 6
♥ A Q J 8 5 2	♥ 6	♥ K 9 7 3
♦ A 9	♦ Q J 10 8 7 4	♦ K 3
♣ K J 7 6	♣ A Q 9 5	♣ 10 4 3

N	
W	E
S	

♠ A K Q J 10 2
♥ 10 4
♦ 6 5 2
♣ 8 2

NS 3♠; EW 3♥; NS 3♦; EW 2♣; Par +100; EW 4♥×-1

West	North	East	South
<i>luojiawei</i>	<i>BridgeGoth</i>	<i>fu_eric</i>	<i>jec</i>
1 ♥	Pass	3 ♥	4 ♠
5 ♥	Dbl	Pass	Pass

Pass

5 ♥× by West

<i>Trick</i>	<i>Lead</i>	<i>2nd</i>	<i>3rd</i>	<i>4th</i>
1. N	♠ 5	6	<u>K</u>	4
2. S	♣ 8	6	<u>Q</u>	3
3. N	<u>♣ A</u>	4	2	7
4. N	♣ 5	10	<u>♥ 4</u>	J
5. S	♦ 2	-	-	-

Down 2 — NS +300